



FEATURES

- Intel® 7th Gen (Kaby Lake-U) Processor Core™ i5-7300U / Core™ i3-7100U
- 1x 260-pin DDR4 SODIMM. max up to 16GB
- 1x 2.5" SATA HDD bay support RAID 0, 1
- 1x mSATA (shared by 1x Mini PCIe),
1x CFast (shared by 1x mSATA), 2x SIM socket
- 2x full-size mini PCIe for communication or expansion modules
- 2x LAN, 1x VGA, 1x DisplayPort, 1x Dual Channel 24 bit LVDS
- 4x RS-232/422/485, 4x USB 3.0, Audio
- 8x DI + 8x DO with isolation
- 2x Universal I/O Bracket for Expansion (PC410 Only)
- 9 to 50VDC wide range power input
- -40°C to 70°C extended operating temperature

SPECIFICATIONS

System

Processor	7 th Gen Intel® Core™ i5-7300U Processor, Dual Core, 3MB Cache, up to 3.5 GHz 7 th Gen Intel® Core™ i3-7100U Processor, Dual Core, 3MB Cache, 2.4 GHz
System Chipset	SoC integrated
LAN Chipset	GbE1: Intel® I219LM (Support Wake-on-LAN and PXE) GbE2: Intel® I210-AT (Support Wake-on-LAN and PXE)
Audio Codec	Realtek ALC888S
System Memory	1x 260-Pin DDR4 1866/2133MHz SODIMM. Max. up to 16GB
BIOS	AMI 128Mbit SPI BIOS
Watchdog	Software Programmable Supports 1~255 sec. System Reset

Display

VGA	1x VGA
DisplayPort	1x DisplayPort
LVDS	1x Dual Channel 24 bit LVDS
Multiple Display	Triple Display

Storage

SSD/HDD	1x Removable 2.5" SATA HDD Bay Support RAID 0, 1
mSATA	1x mSATA (shared by 1x Mini PCIe)
CFast	1x CFast (shared by 1x mSATA)
SIM Socket	2x External SIM socket

Expansion

Mini PCI Express	2x Full-size Mini PCIe
------------------	------------------------

I/O

COM	4x RS-232/422/485 2x RS-232/422/485 (internal)(PC410 only)
USB	4x USB 3.0
LAN	2x RJ45
Audio	1x Mic-in, 1x Line-out
DIO	8 in / 8 out (Isolated)
Universal I/O Bracket	2x Universal I/O Bracket for Expansion (PC410 only)
Others	3x WiFi Antenna Holes (PC400 only) 4x WiFi Antenna Holes (PC410 only) 1x Power Switch, 1x AT/ATX Switch, 1x Remote Power On/Off

Operating System

Windows	Windows 10
Linux	Linux kernel 4.X

Power

Power Mode	AT, ATX
Power Supply Voltage	9-50VDC
Power Ignition Sensing	Power Ignition Management
Power Connector	3-pin Terminal Block
Power Adaptor	Optional AC/DC 12V/5A, 60W
Power Protection	OVP (Over Voltage Protection) OCP (Over Current Protection) Reverse Protection

Environment

Operating Temp.	-40°C to 70°C
Storage Temp.	-40°C to 85°C
Relative Humidity	10%-80% (non-condensing)
IP Level	IP 65 Compliant Front Panel
Vibration	With SSD: 3 Grms, 5 - 500 Hz, 0.5 hr/axis With HDD: 1 Grms, 5 - 500 Hz, 0.5 hr/axis
Shock	With SSD: 20G, half sine, 11ms
Standards / Certification	CE, FCC Class A

Physical

Front Panel Construction	Die-cast Flat Surface
Dimension	PC400: 246 (W) x 220 (D) x 42 (H)mm PC410: 253 (W) x 225 (D) x 64 (H)mm
Weight	PC400: 1.57 Kg PC410: 1.86 Kg
Mounting	VESA Mounting Holes 75 x 75mm, 100 x 100mm

EXTERNAL I/O MECHANICAL LAYOUT

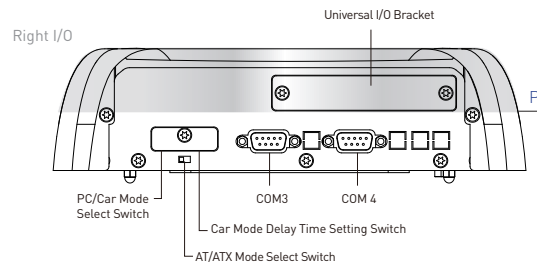
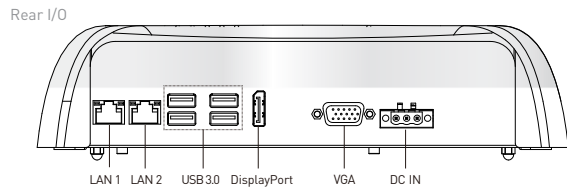
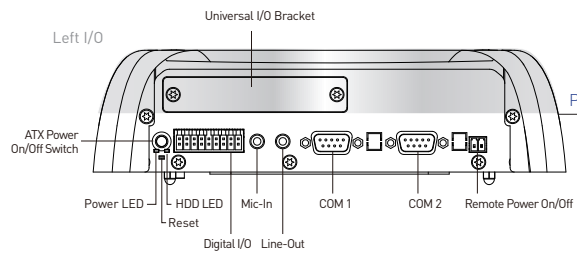
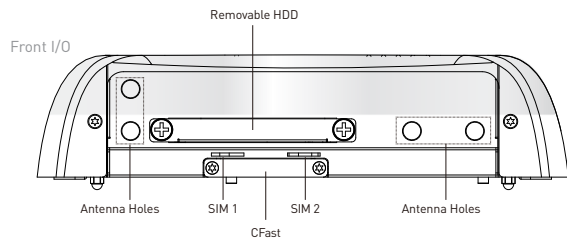

DIMENSION

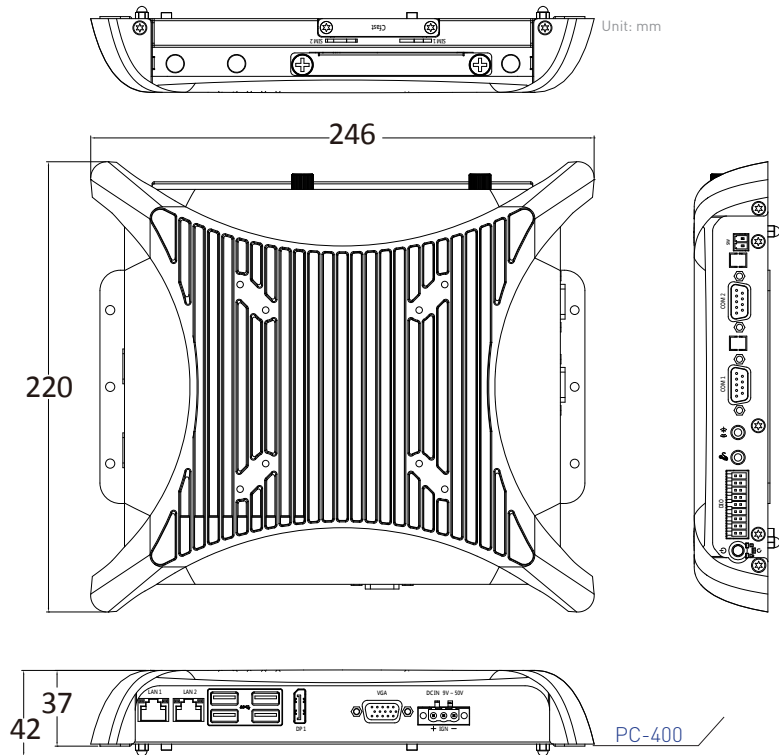

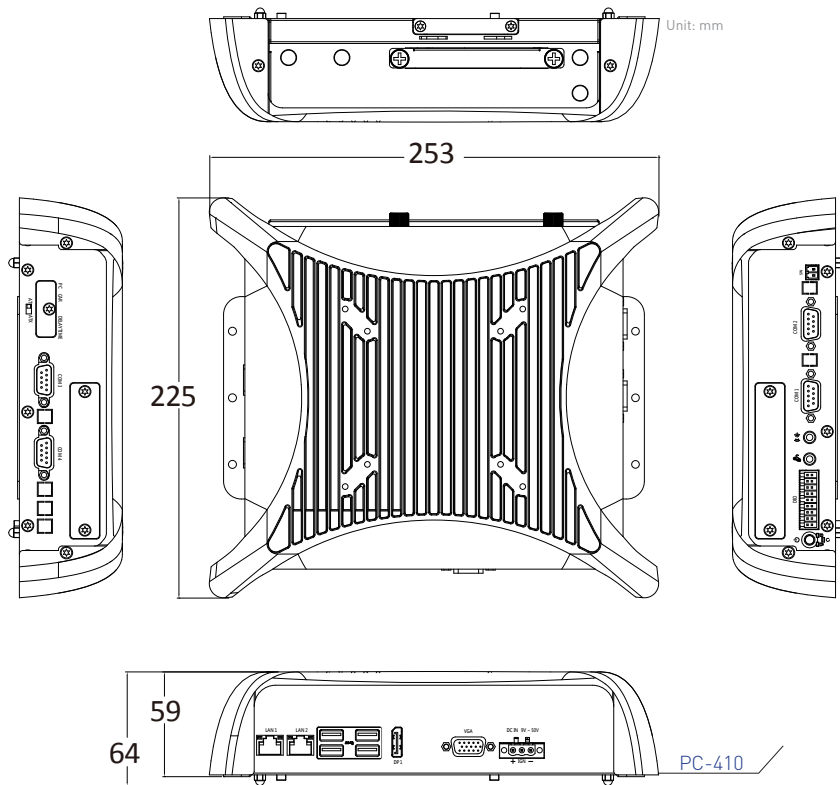

ORDERING INFORMATION

MODEL NO.	DESCRIPTION
1-E09A06008	Adapter AC/DC 12V 5A 60W with 3pin Terminal Block Plug 5.0mm Pitch
SFICBL022	Power Cord, 3-pin US Type, 180cm
1-TPCD00002	Power Cord, European Type
1-TPCD00001	Power Cord, 3-pin UK Type, 180cm

PACKING LIST

- 1x PC400 Series PC Module
- 1x Utility DVD Driver
- 1x Screw Pack

AVAILABLE MODELS

MODEL NO.	DESCRIPTION
PC400-7300U	PC Module for Industrial Display System with Intel® Core™ i5-7300U Processor
PC400-7100U	PC Module for Industrial Display System with Intel® Core™ i3-7100U Processor
PC410-7300U	PC Module for Industrial Display System with Intel® Core™ i5-7300U Processor, 2x Universal I/O Bracket
PC410-7100U	PC Module for Industrial Display System with Intel® Core™ i3-7100U Processor, 2x Universal I/O Bracket