



INDUSTRIAL TOUCH SCREEN COMPUTER

SIO-W215-J1900

15.6" Stainless Steel Panel PC with Intel® Celeron® J1900



Features

- 15.6" Full HD 16:9 LCD with resistive 5-wire / projected capacitive touch
- Intel® Celeron® processor J1900, 2.0 GHz
- 1x 204-pin DDR3L SODIMM. 8 GB
- 1x mSATA (Default 128 GB)
- M12 2x LAN, 4x USB, 2x COM
- 1x Full-size Mini PCIe for expansion
- Support 110V to 240V AC power input
- Fanless Operation from -20°C to 55°C
- Full system IP66/IP69K with Stainless Steel SUS316 construction
- Touch Function ON/OFF Switch
- Scratch-resistant 7H Tempered Glass
- Optical Bonding for ultimate clarity
- Pressure Valve SUS316 VENT IP68

Specifications

Display	
IP Rating	IP66/IP69K
LCD Size	15.6" (16:9)
Max. Resolution	1920 x 1080 (FHD)
Brightness (cd/m ²)	450
Contrast Ratio	800:1
LCD Color	16.2M
Pixel Pitch (mm)	0.17925 (H) x 0.17925 (V)
Surface hardness	>3H
Response time	13ms
Viewing Angle	85 / 85 / 85 / 85 (Typ.) (CR>=10)
Backlight MTBF	60000 hrs (LED Backlight)
Operating Temperature	-30°C to 85°C
Storage Temp.	-40°C to 90°C
Touch	
Surface hardness	Resistive 5-wire >3H Projected Capacitive 7H
Touch points	Resistive Single point Projected Capacitive 2 point
Impact absorption	Projected Capacitive IK07
System	
Processor	Intel® Celeron® Processor J1900, Quad Core, 2MB Cache, 2.0 GHz
System Chipset	SoC Integrated
LAN Chipset	GbE1: Intel® I210-IT (Support Wake-on-LAN and PXE) GbE2: Intel® I210-IT (Support Wake-on-LAN and PXE)
Audio Codec	Realtek ALC886
System Memory	1x 204-pin DDR3L SODIMM. max up to 8GB (Default 8 GB)
TPM	TPM1.2 supported
Storage	
mSATA	1x mSATA (Default 128 GB)
SIM Socket	1x Internal SIM socket
Expansion	
Mini PCIe	1x Full-size Mini PCIe
I/O	
COM	2x RS-232/422/485 by M12 A-Code 8-pin
LAN	2x LAN by M12 X-Code 8-pin
USB	4x USB 2.0 by M12 A-code 8-pin
Others	2x WiFi Antenna (Optional) Power On/Off, Reset IP68/IP69K SUS 316 Vent
Operating System	
Windows	Windows 10, Windows 7, WES7
Linux	Linux kernel 5.X

Power	
Power Mode	ATX
Power Supply Voltage	110 ~ 240V AC Input
Power Connector	M12 S-code 4-pin
Environment	
Operating Temperature	-20°C to 55°C optional wide Temp. -20°C to 60°C
Storage Temperature	-20°C to 70°C
Relative Humidity	10% ~ 80% (non-condensing)
IP Level	Full System IP66/IP69K
Certification	CE, FCC Class A
Vibration	With SSD: 2.4 Grms, 5 - 500 Hz, 0.5 hr/axis With HDD: 1 Grms, 5 - 500 Hz, 0.5 hr/axis
Shock	With SSD: 20G, half sine, 11ms
Physical	
Dimensions	425 (W) x 276(H) x 49.5 (D) mm
Weights	7.39 kg
Construction	Stainless Steel SUS316 with Optical bonding
Mounting Options	VESA Mounting Holes 100 x 100mm Optional Yoke Mount, Panel Mount

External I/O Mechanical Layout

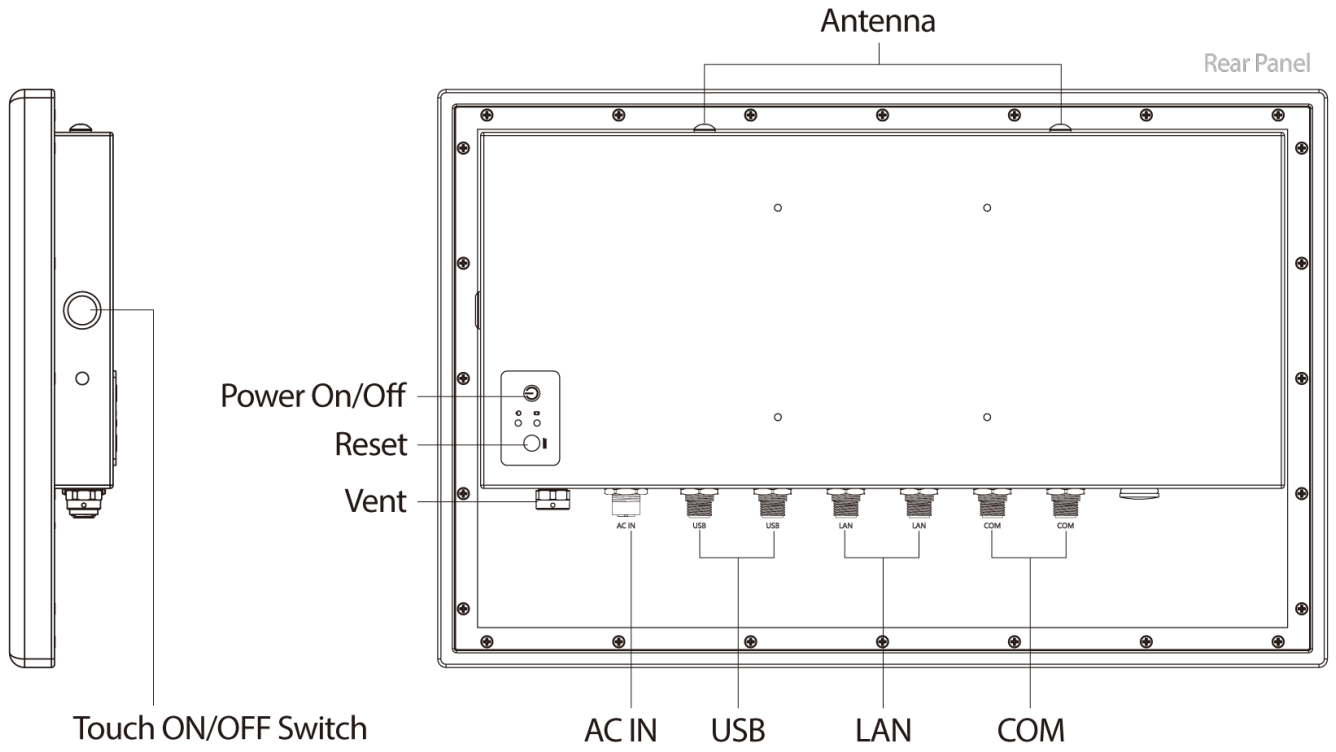

Dimension

Unit: mm

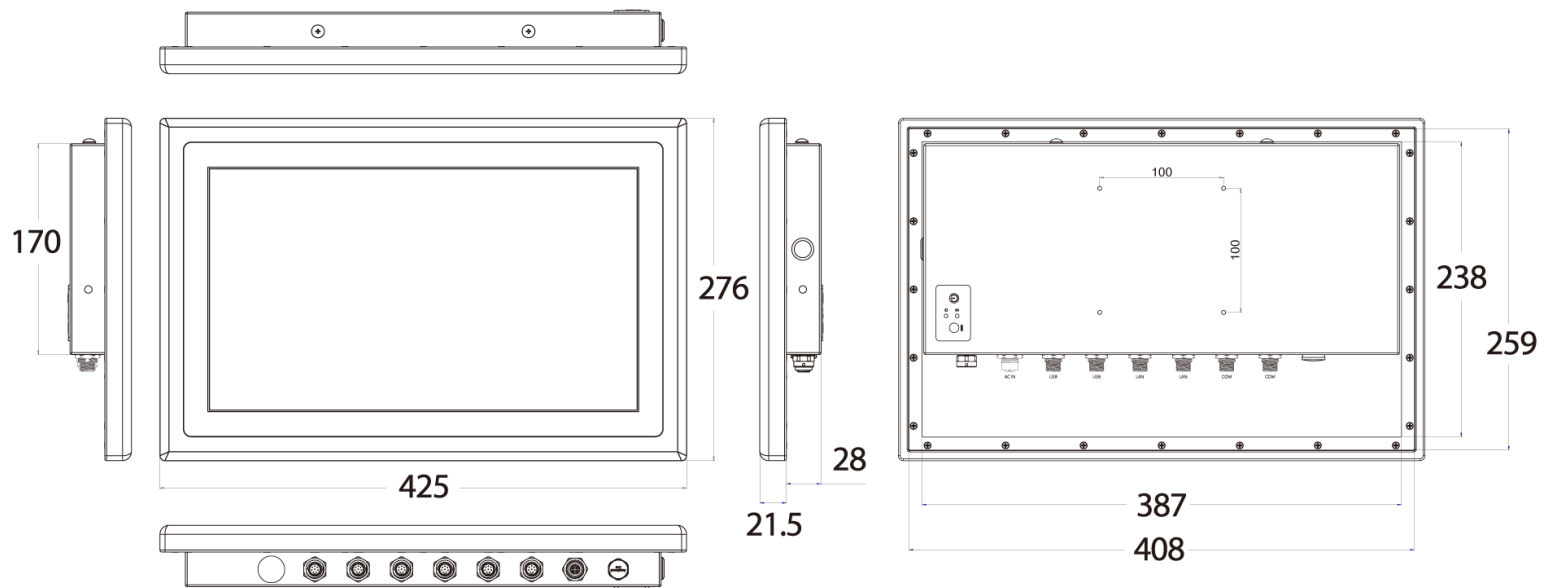

Available Models

Model No.	Description
SIO-W215C-J1900	15.6" FHD Capacitive Touch Stainless Steel Panel PC with Celeron Processor J1900, AC IN, Optical bonding
SIO-W215R-J1900	15.6" FHD Resistive Touch Stainless Steel Panel PC with Celeron Processor J1900, AC IN, Optical bonding

Optional Accessories

Model No.	Description
1-TPWR00092	Waterproof M12 S-CODE 4P PWR Cable(SUS316L)_Type_US L=3M
1-TPWR00106	Waterproof M12 S-CODE 4P PWR Cable(SUS316L)_Type_EU L=3M
1-TCOM00032	Waterproof M12 A-CODE 8P COM Cable(SUS316L)_DB9 L=1.5M
1-TLAN00024	Waterproof M12 X-CODE 8P LAN Cable(SUS316L)_CAT 5E_RJ45 L=1.5M
1-TUSB00057	Waterproof M12 A-CODE 8P USB 2.0 Cable(SUS316L)_Type A*2 L=1.6M

Packing List

- 1x SIO-W215-J1900
- 7x Waterproof Connector Cover Set