

USER'S MANUAL



CT-MCL01 Series

Micro-ATX Industrial Motherboard

Table of Contents

Safety Information	04
About This Guide	05
Typography	06
Packing List	06
Revision History	06
Specifications Summary	07
Block Diagram	08
Chapter 1 Product Introductions	09
1.1 Before you Proceed	10
1.2 Motherboard Overview	10
1.2.1 Placement Direction	10
1.2.2 Screw Holes	11
1.2.3 Motherboard Layout	12
1.2.4 Layout Content List	13
1.3 Central Processing Unit (CPU)	15
1.3.1 Installing the CPU	15
1.3.2 Installing the CPU Heatsink and Fan	17
1.3.3 Uninstalling the CPU Heatsink and Fan	19
1.4 System Memory	21
1.4.1 Overview	21
1.4.2 Installing a DIMM	22
1.4.3 Removing a DIMM	22
1.5 Expansion Card	23
1.5.1 Installing an Expansion Card	23
1.5.2 Configuring an Expansion Card	23
1.5.3 PCI Express x16 slot	23
1.5.4 PCI Express x1 slot	24
1.5.5 PCI Express x4 slot	24
1.5.6 M.2 M Key slot	25
1.5.7 M.2 E Key slot	25
1.6 Jumpers	26
1.6.1 Clear CMOS (JCMOS1)	26
1.6.2 AT/ATX Power Mode Select (JPSON1)	27
1.7 Connectors	28
1.7.1 Rear panel connectors	28
1.7.2 CPU and System fan connectors (CPU_FAN, SYS_FAN1, SYS_FAN2)..	29
1.7.3 System Panel (F_PANEL1)	30
1.7.4 ATX power connectors (EATXPWR1 & ATX12V1)	31
1.7.5 Serial Port connectors (COM3~6)	31
1.7.6 Serial ATA Connector (SATA1~6)	32
1.7.7 USB connectors (USB78, USB910, USB1112, USB13)	32
1.7.8 USB3.0 connector (USB56)	33

	1.7.9 8 bit GPIO header (JDIO1)	33
	1.7.10 Front Audio connector (FP_AUDIO1)	34
	1.7.11 SM bus connector (JSMB1)	34
	1.7.12 LPC connector (JLPC1)	35
	1.7.13 SPI connector (SPI1)	35
Chapter 2	BIOS Setup	36
2.1	General Features	37
2.2	POST Error Beep Requirements	37
2.3	BIOS Hotkey Requirements	38
2.4	South Bridge Features	38
2.5	ACPI function	39
2.6	OEM full screen logo	40
2.7	SuperIO Feature Support	40
2.8	Boot Option	41
2.9	Trust Computing	41
2.10	Main Setup	42
2.11	Advanced BIOS Setup	43
	2.11.1 CPU Configuration	44
	2.11.2 Power & Performance	44
	2.11.3 PCH-FW Configuration	46
	2.11.4 ACPI Settings	46
	2.11.5 NCT6106D Super IO Configuration	47
	2.11.6 NCT6106D HW Monitor	51
	2.11.7 Trusted Computing	52
	2.11.8 S5 RTC Wake Setting	53
	2.11.9 Serial Port Console Redirection	53
	2.11.10 Intel TXT Information	54
	2.11.11 USB Configuration	54
	2.11.12 CSM Configuration	55
	2.11.13 NVME Configuration	55
	2.11.14 Network Stack Configuration	56
2.12	Chipset	57
	2.12.1 System Agent (SA) Configuration	57
	2.12.2 PCH-IO Configuration	59
2.13	Security	65
	2.13.1 Secure Boot	65
2.14	Boot	66
2.15	Save & Exit	67
Appendix	GPIO & WDT	68
	General Purpose Input Output	69
	Watchdog Timer	71

Safety Information

Electrical Safety

- To prevent electrical shock hazard, disconnect the power cable from the electrical outlet before relocating the system.
- When adding or removing devices to or from the system, ensure that the power cables for the devices are unplugged before the signal cables are connected. If possible, disconnect all power cables from the existing system before you add a device.
- Before connecting or removing signal cables from the motherboard, ensure that all power cables are unplugged.
- Seek professional assistance before using an adapter or extension cord. These devices could interrupt the grounding circuit.
- Make sure that your power supply is set to the correct voltage in your area. If you are not sure about the voltage of the electrical outlet you are using, contact your local power company.
- If the power supply is broken, do not try to fix it by yourself. Contact a qualified service technician or your retailer.

Operation Safety

- Before installing the motherboard and adding devices on it, carefully read all the manuals that came with the package.
- Before using the product, make sure all cables are correctly connected and the power cables are not damaged. If you detect any damage, contact your dealer immediately.
- To avoid short circuits, keep paper clips, screws, and staples away from connectors, slots, sockets and circuitry.
- Avoid dust, humidity, and temperature extremes. Do not place the product in any area where it may become wet.
- Place the product on a stable surface.
- If you encounter technical problems with the product, contact a qualified service technician or your retailer.



The symbol of the crossed out wheeled bin indicates that the product (electrical and electronic equipment) should not be placed in municipal waste. Check local regulations for disposal of electronic products.

Safety Declaration

This device complies with the requirements in Part 15 of the FCC rules. Operation is subject to the following two conditions:

- This device may not cause harmful interference.
- This device must accept any interference received, including interference that may cause undesired operation.

About this guide

This user guide contains the information you need when installing and configuring the motherboard.

How this guide is organized

This manual contains the following parts:

- **Chapter 1: Product introduction**

This chapter describes the features of the motherboard and the new technology it supports. This chapter also lists the hardware setup procedures that you have to perform when installing system components. It includes description of the jumpers and connectors on the motherboard.

- **Chapter 2: BIOS setup**

This chapter tells how to change system settings through the BIOS Setup menus. Detailed descriptions of the BIOS parameters are also provided.

Where to find more information

Refer to the following sources for additional information and for product and software updates.

1. Technical Support

If a problem arises with your system and no solution can be obtained from the user's manual, please contact your place of purchase or local distributor.

2. Optional documentation

Your product package may include optional documentation, such as warranty flyers, that may have been added by your dealer. These documents are not part of the standard package.

Conventions used in this guide

To make sure that you perform certain tasks properly, take note of the following symbols used throughout this manual.



DANGER/WARNING: Information to prevent injury to yourself when trying to complete a task.



CAUTION: Information to prevent damage to the components when trying to complete a task.



IMPORTANT: Instructions that you **MUST** follow to complete a task.



NOTE: Tips and additional information to help you complete a task.

Typography

Bold text	Indicates a menu or an item to select
<i>Italics</i>	Used to emphasize a word or a phrase
<Key>	Keys enclosed in the less-than and greater-than sign means that you must press the enclosed key Example: <Enter> means that you must press the Enter or Return key
<Key1>+<Key2>+<Key3>	If you must press two or more keys simultaneously, the key names are linked with a plus sign (+) Example: <Ctrl>+<Alt>+<D>
Command	Means that you must type the command exactly as shown, then supply the required item or value enclosed in brackets Example: At the DOS prompt, type the command line:

Packing List

Before you begin installing your single board, please make sure that the following materials have been shipped:

- 1 x CT-MCL01 Micro-ATX Main board
- 1 x I/O Shield
- 1 x SATA Cable



If any of the above items is damaged or missing, please contact your retailer.

Revision History

Revision	Revision History	Date
V1	First release version	Mar., 2020

Specifications Summary

System

- CPU: Intel® LGA1151 socket supports Intel® Core™ i7/ i5/ i3 CPU
- BIOS: AMI 256MB SPI ROM
- System Chipset: Intel® Q370
- Memory: 4x DIMM Up to 64GB Dual Channel DDR4 2133/2400/2666 (depend on CPU) MT/s
- Watchdog Timer: 1~255 sec timer
- H/W Status Monitor:
 - CPU & system temperature monitoring
 - Voltages monitoring
- Expansion Slots
 - 1 x PCIe x 16 Slot (Black)
 - 2 x PCIe x 4 Slot (Black)
 - 1 x PCIe x 1 Slot (Black)
 - 1 x M.2 M / NVMe PCIe x 4 / SATA / 2242, 2260, 2280
 - 1 x M.2 E / PCIe x2 / USB 2.0 / 2230
- Smart Fan Control: Yes

Display

- Chipset: Intel® Integrated Graphic (CPU Dependent)
- Display Memory: Shared Memory

Ethernet

- LAN1: Intel® I219-LM PHY LAN Controller
- LAN2: Intel® I211-AT PCIe LAN Controller (Co-Lay Intel® I210-AT)

Back I/O Port

- **Back Panel**
 - 2 x RS-232/422/485 DB9 Connector
 - 2 x Display Port Connector
 - 1 x VGA Connector
 - 1 x DVI-D Connector
 - 2 x Stack up RJ45 and USB 3.1 Gen 2 Connectors
 - 1 x 3 Jacks Audio Connector

Internal I/O Connector

- **Intel I/O**
 - 6 x SATAIII connectors(RED) (SATA1 shared with M.2 M key)
 - 4 x USB 2.0 headers support 7 ports
 - 1 x USB 3.1 Gen1 box header support 2 port
 - 4 x RS232 2.00 mm box header
 - 1 x LPC box header
 - 1 x SPI header
 - 1 x Front Audio header
 - 1 x CPU Fan connector
 - 2 x SYS Fan connector
 - 1 x Front panel header
 - 1 x 8 bits GPIO box header
 - 1 x Horizontal Socket Type CMOS Battery Holder
 - 1 x 24-pin ATX Power connector
 - 1 x 8-pin ATX 12V Power connector

Mechanical & Environment

- Operating Temp.: 0°C ~ 60°C (32°F ~ 140°F)
- Operating Humidity: at 40C 95% relative humidity, non-condensing
- Size (L x W): 9.6 inch x 9.6 inch

Block Diagram

CT-MCL01 Board Diagram

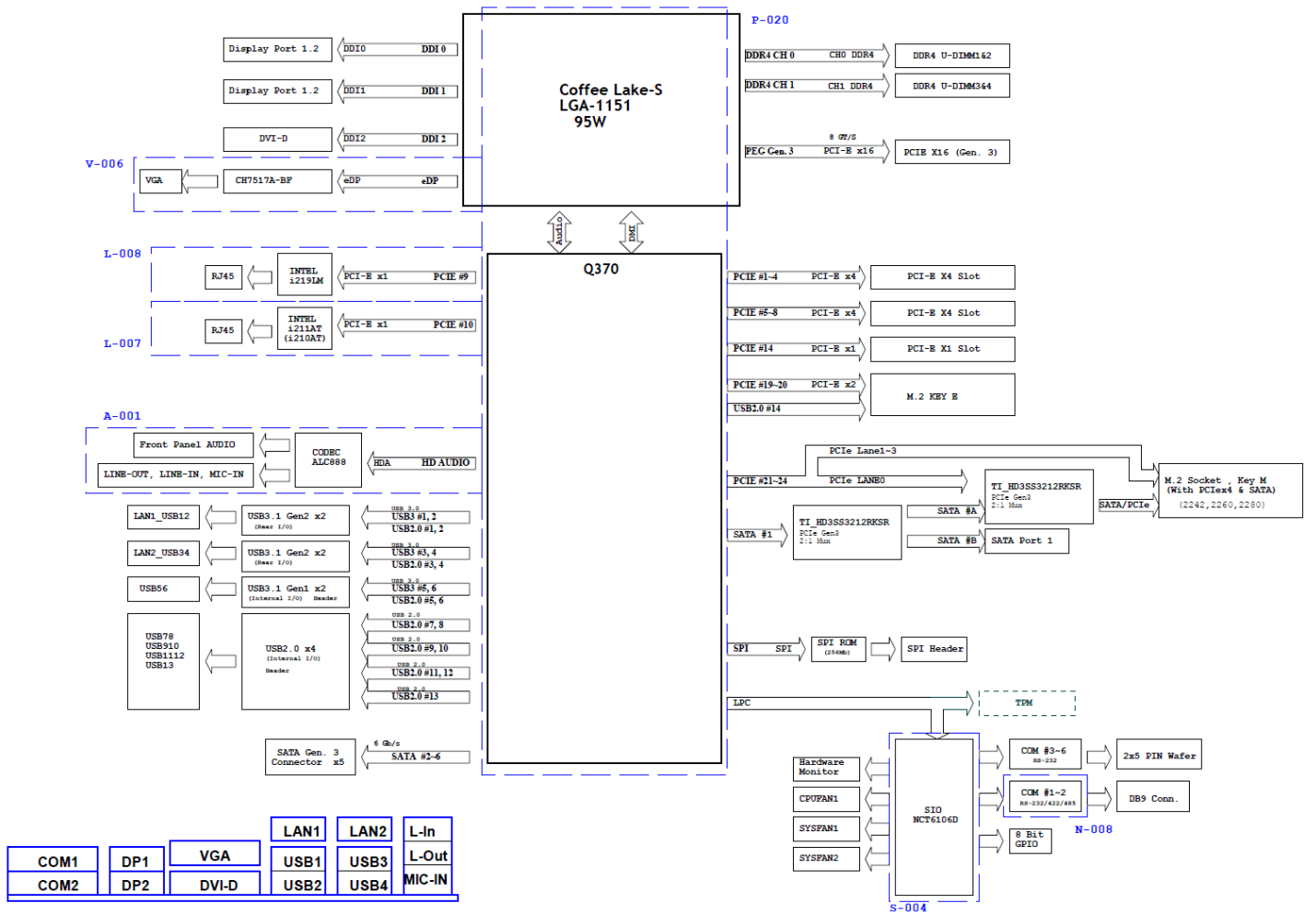

Chapter 1

Product Introductions

1.1 Before you proceed

Take note of the following precautions before you install motherboard components or change any motherboard settings.



- Unplug the power cord from the wall socket before touching any component.
- Use a grounded wrist strap or touch a safely grounded object or a metal object, such as the power supply case, before handling components to avoid damaging them due to static electricity
- Hold components by the edges to avoid touching the ICs on them.
- Whenever you uninstall any component, place it on a grounded anti-static pad or in the bag that came with the component.
- Before you install or remove any component, ensure that the ATX power supply is switched off or the power cord is detached from the power supply. Failure to do so may cause severe damage to the motherboard, peripherals, and/or components.

1.2 Motherboard Overview

Before you install the motherboard, study the configuration of your chassis to ensure that the motherboard fits into it. Refer to the chassis documentation before installing the motherboard.



Make sure to unplug the power cord before installing or removing the motherboard. Failure to do so can cause you physical injury and damage motherboard components.

1.2.1 Placement Direction

When installing the motherboard, make sure that you place it into the chassis in the correct orientation. The edge with external ports goes to the rear part of the chassis as indicated in the image below.

1.2.2 Screw Holes

Place eight (8) screws into the holes indicated by circles to secure the motherboard to the chassis.



Do not over tighten the screws! Doing so can damage the motherboard.

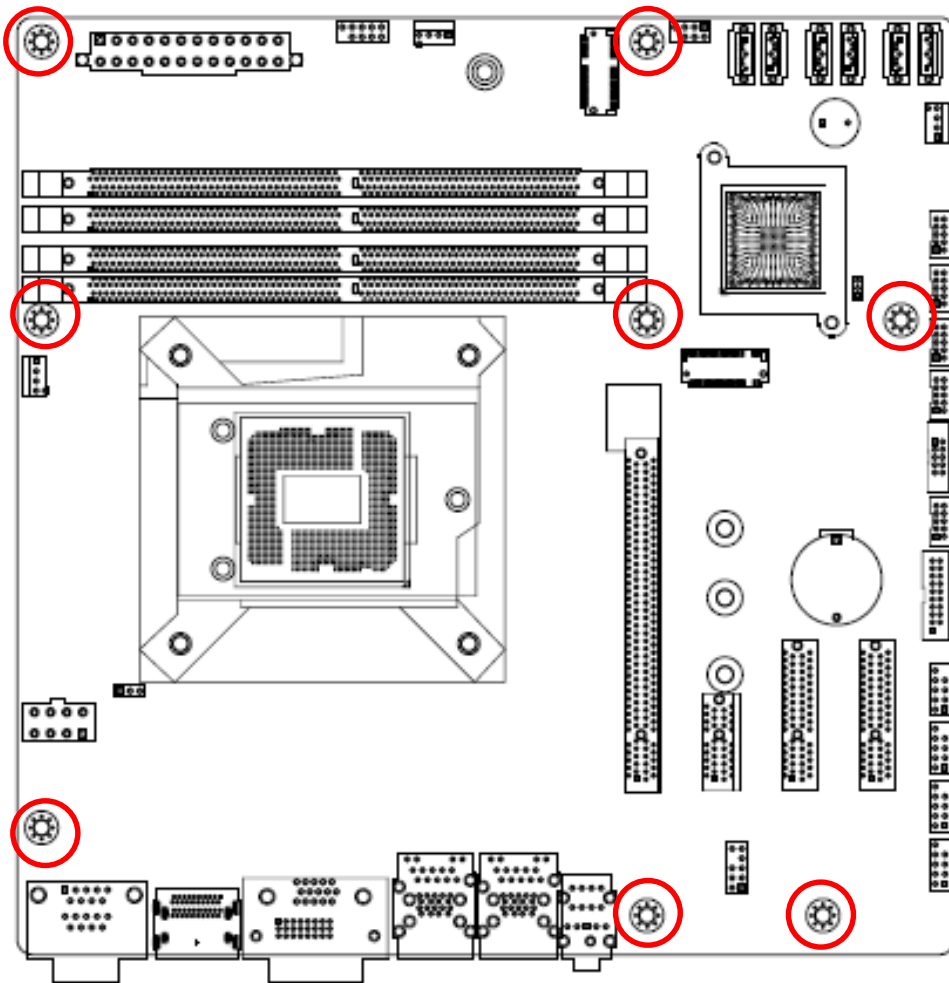

Place this side towards the rear of the chassis.

1.2.3 Motherboards Layout

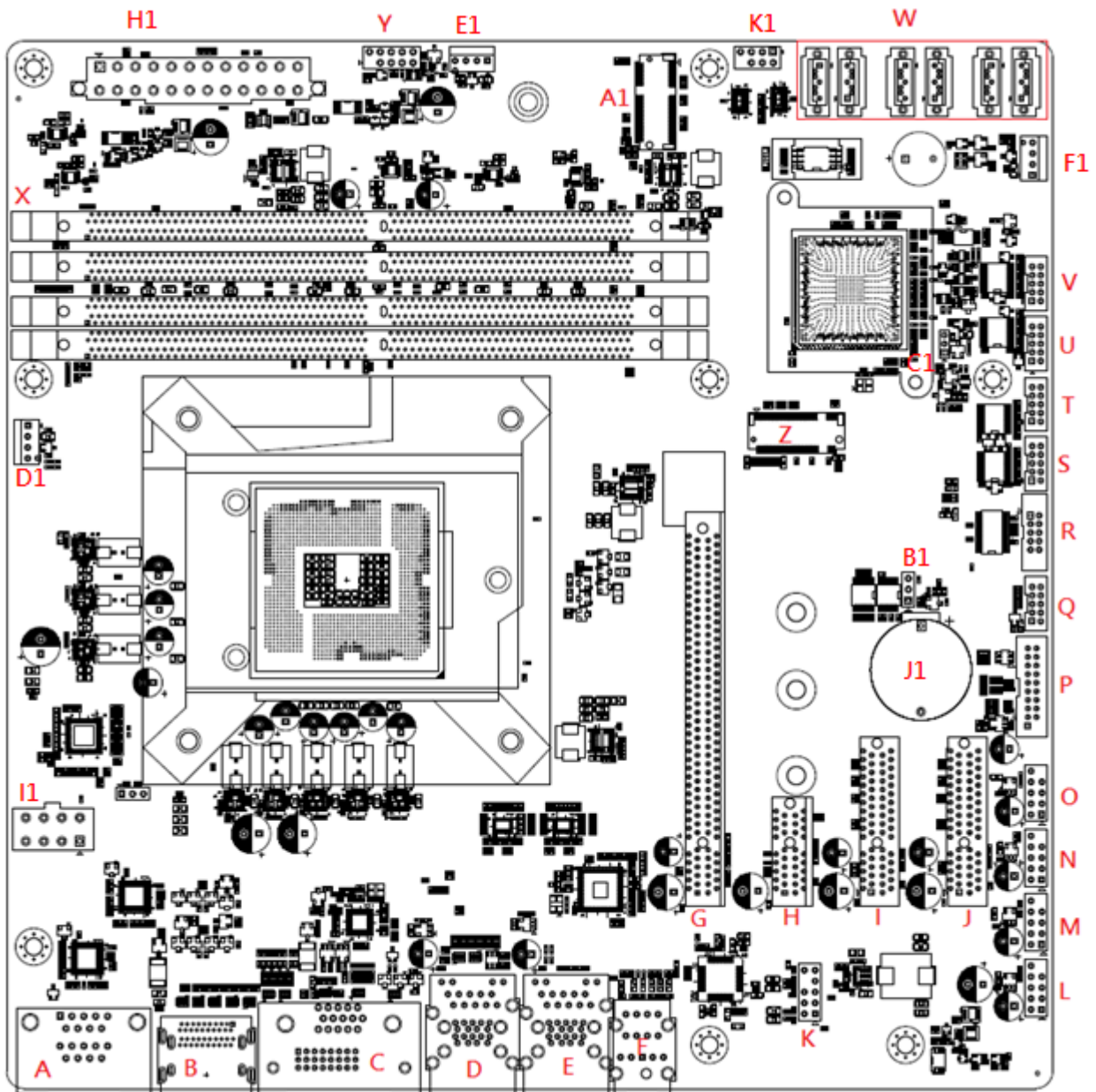

1.2.4 Layout Content List

Slots & sockets		
Label	Function	Note
CPU1	LGA1151 socket	
DIMMA1~B2 (X)	DDR4 DIMM Slot A1~B2	
PCIEX16_1 (G)	PCI-e x16 Slot	
PCIEX1_1 (H)	PCI-e x1 Slot	
PCIEX4_1 (I)	PCI-e x4 Slot	
PCIEX4_2 (J)	PCI-e x4 Slot	

Jumpers		
Label	Function	Note
JCMOS1 (B1)	Clear CMOS	3 x 1 header, pitch 2.54mm
JPERSON1 (C1)	AT/ATX Mode Select	3 x 1 header, pitch 2.54mm

Rear Panel Connector		
Label	Function	Note
COM12 (A)	2 COM port connector	COM1(upper)+COM2(lower)
DP1+DP2 (B)	DP+ DP connector	DP1(upper)+DP2(lower)
DVI-D1+VGA1 (C)	DVI-D+ VGA connector	VGA(upper)+DVI(lower)
LAN1_USB12 (D)	RJ-45 Ethernet Connector x 1 USB 3.1 Gen2 Connector x 2	
LAN2_USB34 (E)	RJ-45 Ethernet Connector x 1 USB 3.1 Gen2 Connector x 2	
AUDIO1 (F)	3 port audio jack	Light Blue: Line-in, Lime: Line-out, Pink: Mic-in

Internal Connector		
Label	Function	Note
CPU_FAN1 (D1)	CPU fan connector	4 x 1 wafer, pitch 2.54mm
SYS_FAN1 (E1)	System fan connector	4 x 1 wafer, pitch 2.54mm
SYS_FAN2 (F1)	Chassis fan connector	4 x 1 wafer, pitch 2.54mm
F_PANEL1 (Y)	Intel front panel connector	5 x 2 header, pitch 2.54mm
EATXPWR1 (H1)	ATX power connector	12 x 2 wafer
ATX12V1 (I1)	12V ATX power connector	2 x 4 wafer
COM3 ~ 6 (S,T,U,V)	Serial port connector	5 x 2 wafer, pitch 2.00mm
SATA1 ~ 6 (W)	SATA data connector	7P Male connector
USB78/910/1112/13 (L,M,N,O)	USB2.0 connector	5x2 header, pitch 2.00mm
USB56 (P)	USB 3.1 Gen1 connector	10 x 2 wafer, pitch 2.00mm
M2_1 (Z)	M.2 connector	M.2 Key M
M2_2 (A1)	M.2 connector	M.2 Key E
BAT1 (J1)	RTC battery holder	
SPI1 (K1)	SPI header	4 x 2 header, pitch 2.54mm
JLPC1 (R)	Port 80	5 x 2 wafer, pitch 2.00mm
JDIO1 (Q)	DIO connector	5 x 2 wafer, pitch 2.00mm
FP_AUDIO1 (K)	Front audio header	5 x 2 header, pitch 2.54mm

1.3 Central Processing Unit (CPU)

The motherboard comes with a surface mount LGA1151 socket designed for the Intel® Core™ i7/ i5/ i3 processor in the 1151-land package.



- Your boxed Intel® Core™ i7/ i5/ i3 LGA1155 processor package should come with installation instructions for the CPU, fan and heatsink assembly. If the instructions in this section do not match the CPU documentation, follow the latter.
- Upon purchase of the motherboard, make sure that the PnP cap is on the socket and the socket pins are not bent. Contact your retailer immediately if the PnP cap is missing, or if you see any damage to the PnP cap/socket pins/motherboard components. ADVANSUS will shoulder the cost of repair only if the damage is shipment/transit-related.
- Keep the cap after installing the motherboard. ADVANSUS will process Return Merchandise Authorization (RMA) requests only if the motherboard comes with the cap on the LGA1151 socket.
- The product warranty does not cover damage to the socket pins resulting from incorrect CPU installation/removal, or misplacement/loss/incorrect removal of the PnP cap.
- Install the CPU fan and heatsink assembly before you install motherboard to the chassis.



If you purchased a separate CPU heatsink and fan assembly, make sure that you have properly applied Thermal Interface Material to the CPU heatsink or CPU before you install the heatsink and fan assembly.

1.3.1 Installing the CPU

1. Locate the CPU socket on the motherboard.

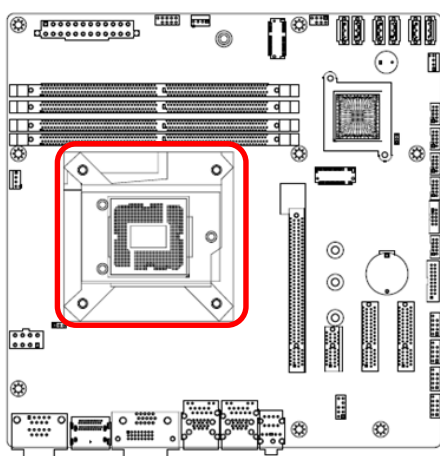

Before installing the CPU, make sure that the socket box is facing towards you and the load lever is on your left.

2. Press the load lever with your thumb (A), then move it to the left (B) until it is released from the retention tab.

Retention tab

Load lever

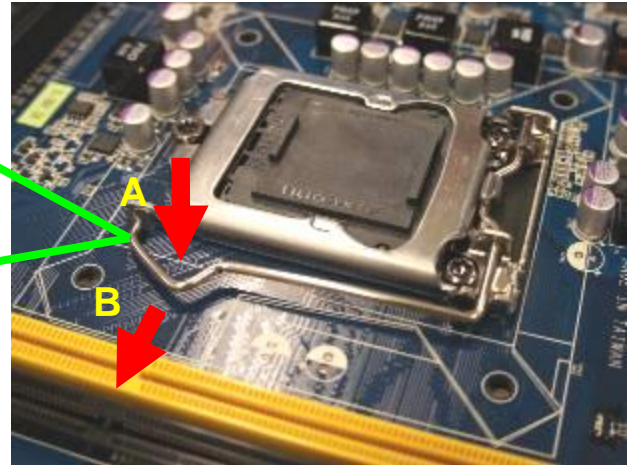

To prevent damage to the socket pins, do not remove the PnP cap unless you are installing a CPU.

3. Lift the Load lever with your thumb and forefinger to around 180° angle (A), then pull the PnP cap from the CPU socket to remove (B).



4. Position the CPU over the socket, making sure that the gold triangle is on the top-left corner of the socket then fit the socket alignment key into the CPU notch.

CPU notch

Gold triangle

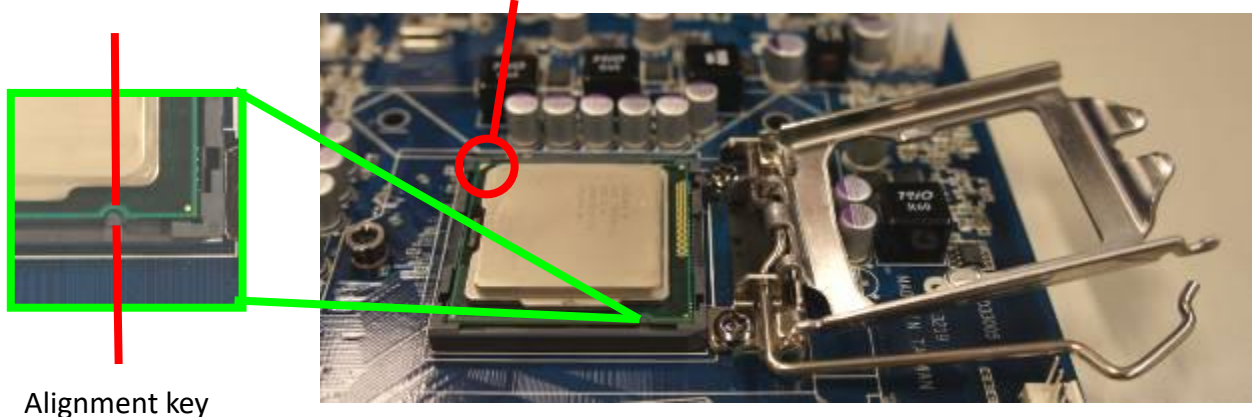

Alignment key

5. Pull back the load lever, then push the load lever (A) until it snaps into the retention tab.



The CPU fits in only one correct orientation. DO NOT force the CPU into the socket to prevent bending the connectors on the socket and damaging the CPU!

1.3.2 Installing the CPU Heatsink and Fan

Intel® Core™ i7/ i5/ i3 LGA1151 processor requires a specially designed heatsink and fan assembly to ensure optimum thermal condition and performance.



- Install the motherboard to the chassis before you install the CPU fan and heatsink assembly.
- When you buy a boxed Intel® Core™ i7/ i5/ i3 LGA1151 processor, the package includes the CPU fan and heatsink assembly. If you buy a CPU separately, make sure that you use only Intel® certified multi-directional heatsink and fan.
- Your Intel® Core™ i7/ i5/ i3 LGA1151 processor LGA1151 heatsink and fan assembly comes in a push-pin design and requires no tool to install.



If you purchased a separate CPU heatsink and fan assembly, make sure that you have properly applied Thermal Interface Material to the CPU heatsink or CPU before you install the heatsink and fan assembly.

To install the CPU heatsink and fan:

1. Place the heatsink on top of the installed CPU, making sure that the four fasteners match the holes on the motherboard.

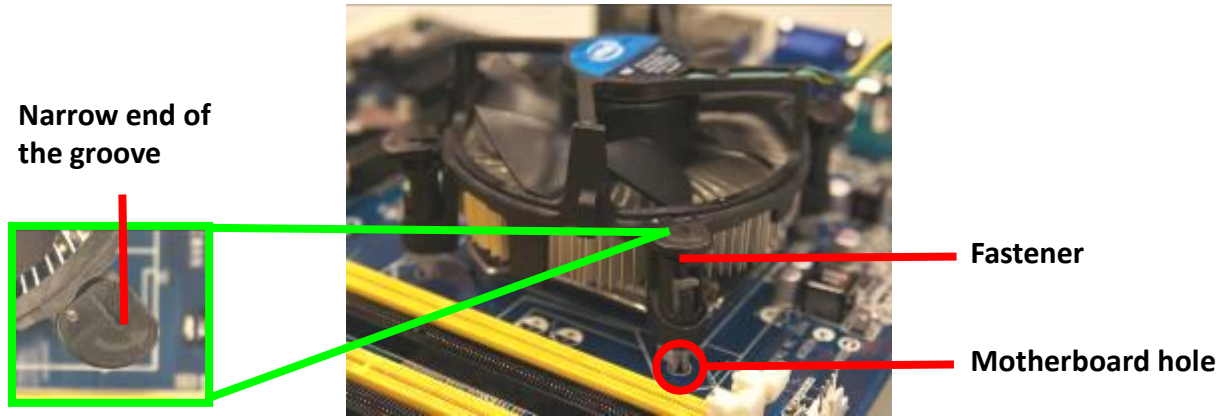

Orient the heatsink and fan assembly such that the CPU fan cable is closest to the CPU fan connector.



Make sure each fastener is oriented as shown, with the narrow groove directed outward.

2. Push down two fasteners at a time in a diagonal sequence to secure the heatsink and fan assembly in place.

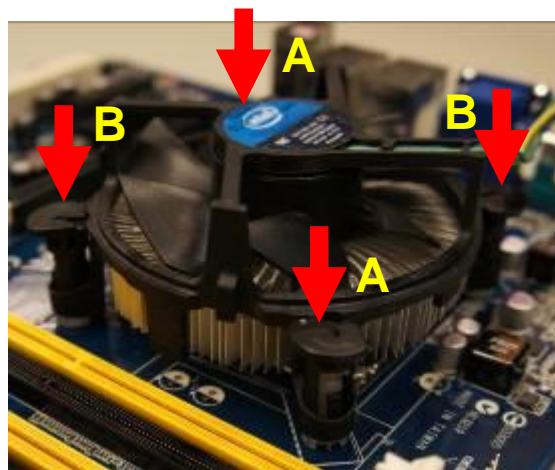
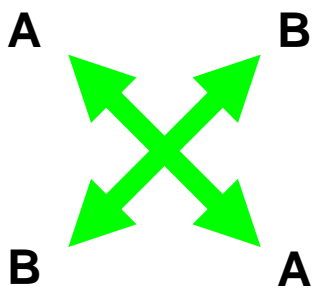

3. Connect the CPU fan cable to the connector on the motherboard labeled CPU_FAN1.

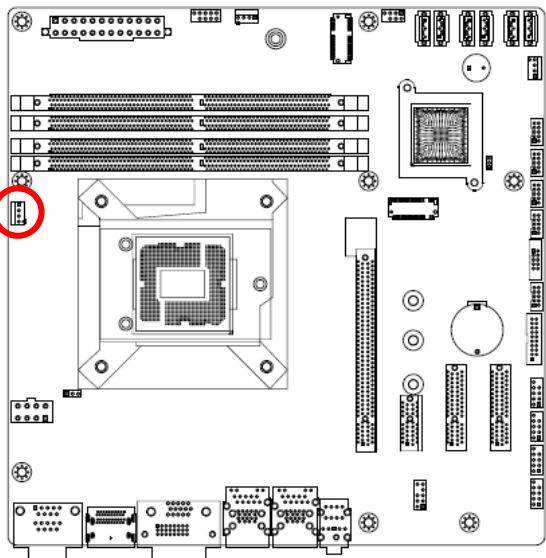

CPU FAN1

- 4. FAN_PWM1_C
- 3. FANCPUDEC1
- 2. +V12
- 1. GND



Do not forget to connect the fan cables to the fan connectors. Insufficient air flow inside the system may damage the motherboard components. These are not jumpers! DO NOT place jumper caps on the fan connectors.

1.3.3 Uninstalling the CPU Heatsink and Fan

To uninstall the CPU heatsink and fan:

1. Disconnect the CPU fan cable from the connector on the motherboard.
2. Rotate each fastener counterclockwise

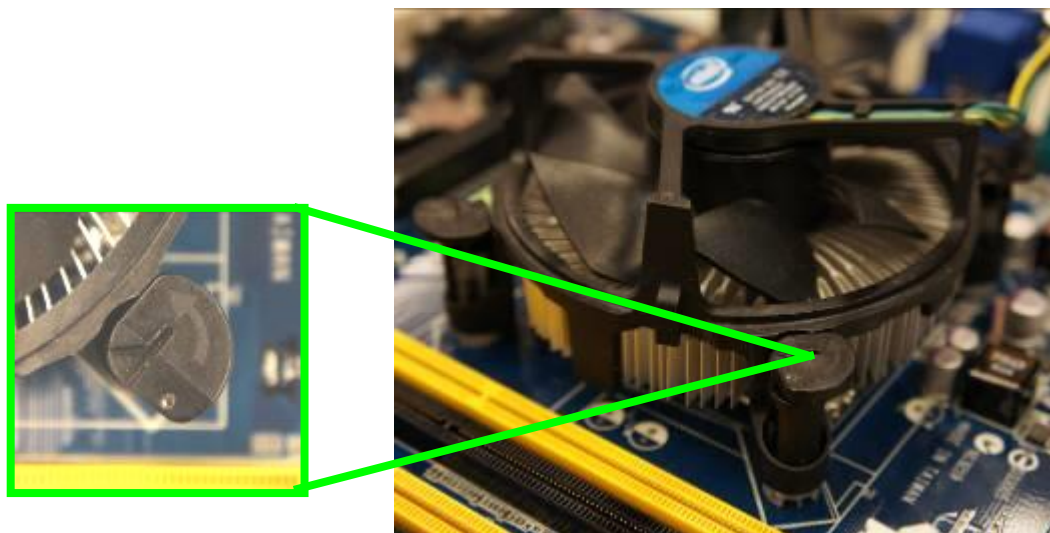

3. Pull up two fasteners at a time in a diagonal sequence to disengage the heatsink and fan assembly from the motherboard.

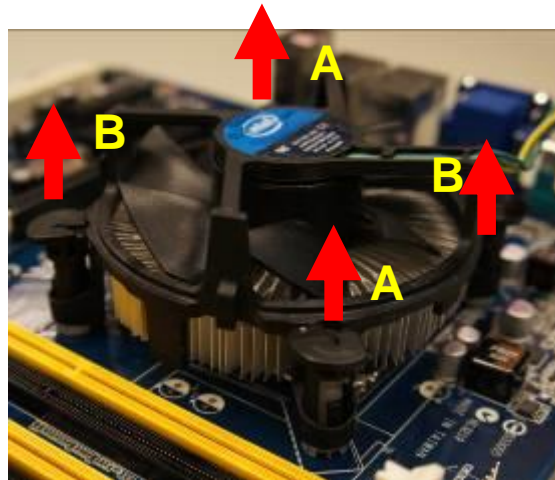
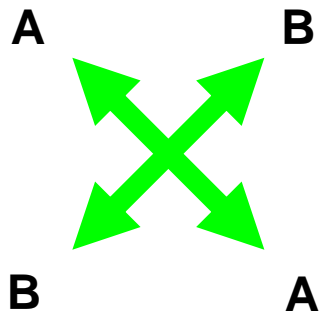

4. Carefully remove the heatsink and fan assembly from the motherboard.



5. Rotate each fastener clockwise to ensure correct orientation when reinstalling.



1.4 System Memory

1.4.1 Overview

The motherboard comes with four 288-pin Double Data Rate 4 (DDR4) Dual Inline Memory Modules (DIMM) sockets.

DDR4 SDRAM, an abbreviation for double data rate fourth generation synchronous dynamic random-access memory, is a type of synchronous dynamic random-access memory (SDRAM) with a high bandwidth ("double data rate") interface. The primary advantages of DDR4 over its predecessor, DDR3, include higher module density and lower voltage requirements, coupled with higher data rate transfer speeds. DDR4 memory comes in 288-pin DIMM modules, similar in size to 240-pin DDR3 DIMMs. The pins are spaced more closely (0.85 mm instead of 1.0) to fit the increased amount within the same 5¼ inch (133.35 mm) standard DIMM length but, the height is increased slightly (31.25 mm/1.23 in instead of 30.35 mm/1.2 in) to make signal routing easier, and the thickness is also increased (to 1.2 mm from 1.0) to accommodate more signal layers. DDR4 DIMM modules have a slightly curved edge connector so not all of the pins are engaged at a time during module insertion, lowering the insertion force.

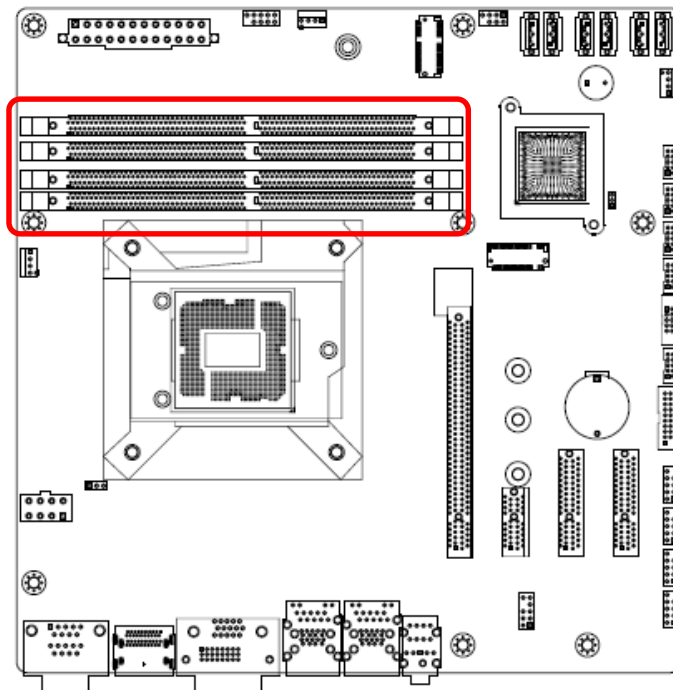

288-Pin DDR4 U-DIMM sockets

1.4.2 Installing a DIMM



Make sure to unplug the power cord before installing or removing the motherboard. Failure to do so can cause you physical injury and damage motherboard components.

1. Locate the DIMM socket on the board.
2. Hold two edges of the DIMM module carefully, and keep away of touching its connectors.
3. Align the notch key on the module with the rib on the slot.
4. Firmly press the modules into the socket which will automatically snap into the mounting notch. Do not force the DIMM module in with extra force as the DIMM module only fits in one direction.

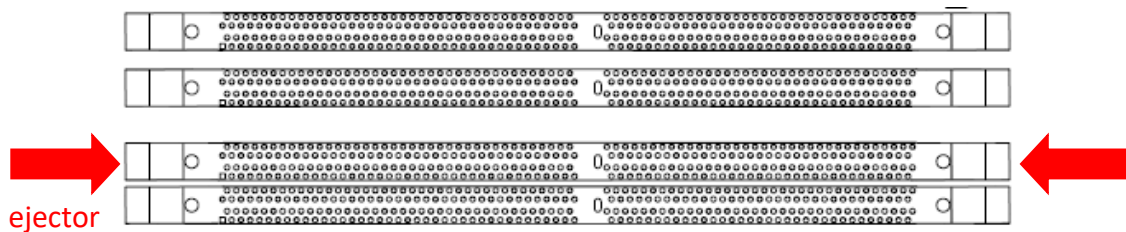

- A DDR4 DIMM is keyed with a notch so that it fits in only one direction. DO NOT force a DIMM into a socket to avoid damaging the DIMM.
- The DDR4 DIMM sockets do not support DDR/DDR2/DDR3 DIMMs. DO NOT install DDR/DDR2/DDR3 DIMMs to the DDR4 DIMM socket.

1.4.3 Removing a DDR4 DIMM

1. Press the two ejector tabs on the slot outward simultaneously, and then pull out the DIMM module.



Support the DIMM lightly with your fingers when pressing the ejector tabs. The DIMM might get damaged when it flips out with extra force.

1.5 Expansion Card

In the future, you may need to install expansion cards. The following sub-sections describe the slots and the expansion cards that they support.



Make sure to unplug the power cord before adding or removing expansion cards. Failure to do so may cause you physical injury and damage motherboard components.

1.5.1 Installing an Expansion Card

1. Before installing the expansion card, read the documentation that came with it and make the necessary hardware settings for the card.
2. Remove the system unit cover (if your motherboard is already installed in a chassis).
3. Remove the bracket opposite the slot that you intend to use. Keep the screw for later use.
4. Align the card connector with the slot and press firmly until the card is completely seated on the slot.
5. Secure the card to the chassis with the screw you removed earlier.
6. Replace the system cover.

1.5.2 Installing an Expansion Card

After installing the expansion card, configure it by adjusting the software settings.

1. Turn on the system and change the necessary BIOS settings, if any. See Chapter 2 for information on BIOS setup.
2. Assign an IRQ to the card if needed. Refer to the tables on the next page.
3. Install the software drivers for the expansion card.

1.5.3 PCI Express x16 Slot

This motherboard supports one PCI Express x16 slot that complies with the PCI Express specifications.

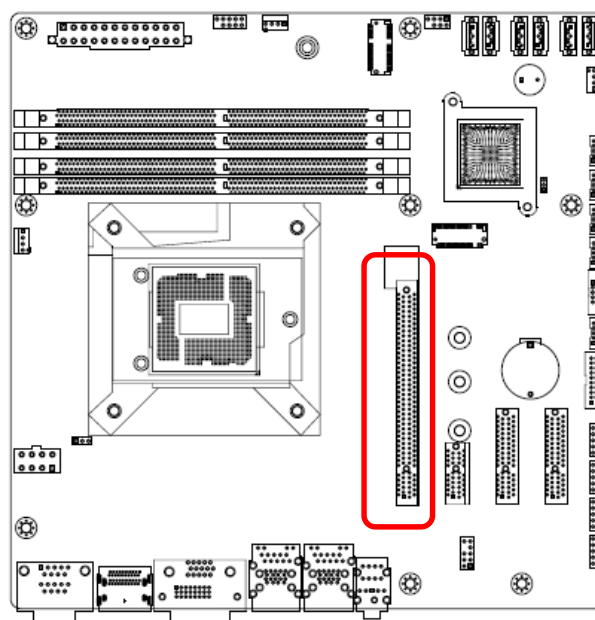

1.5.4 PCI Express x1 slot

This motherboard supports one PCIe x1 slot that complies with the PCIe x1 specifications.

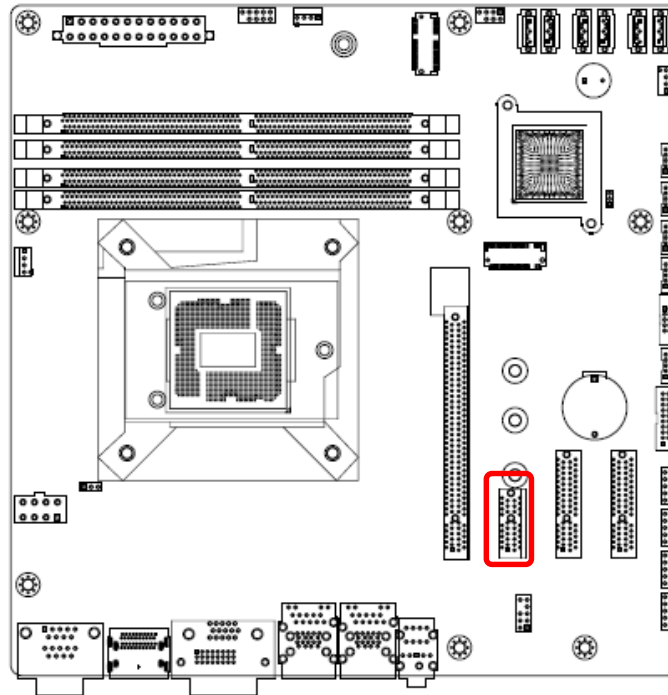

1.5.5 PCI Express x4 slot

This motherboard supports one PCIe x4 slot that complies with the PCIe x4 specifications.

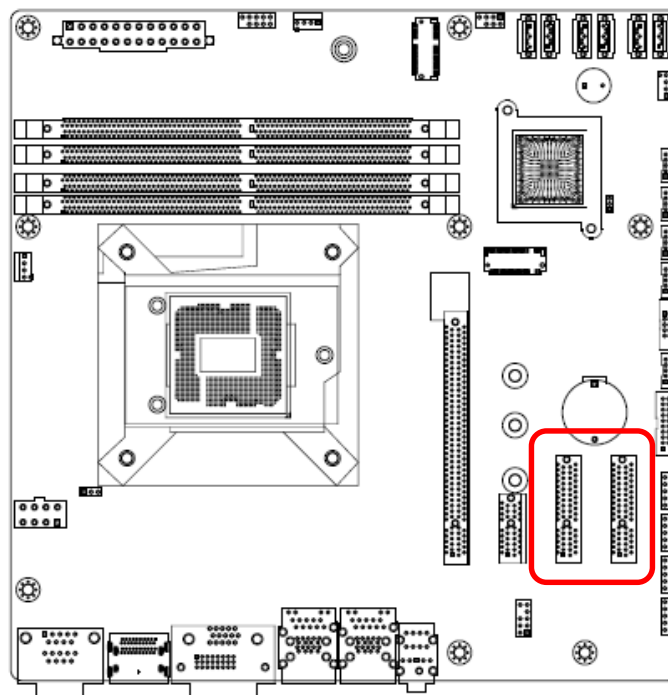

1.5.6 M.2 M Key slot

Support PCIe and SATA interface of this connector.

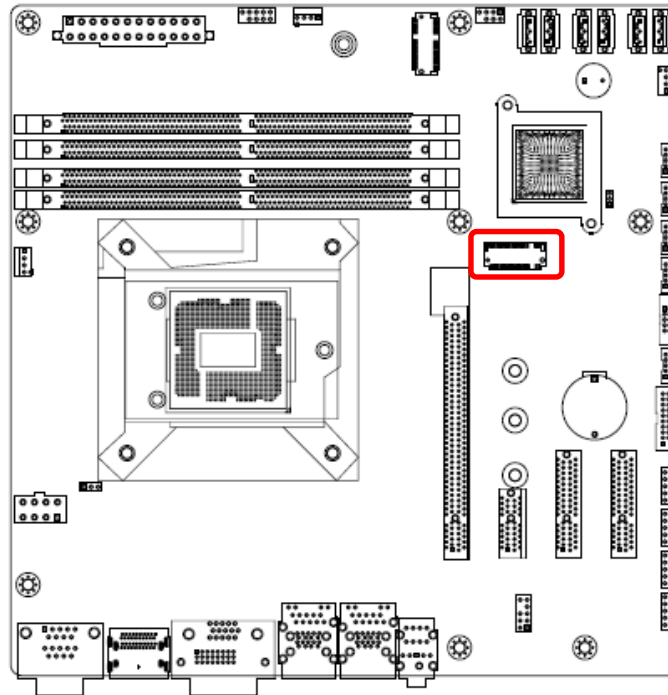

1.5.7 M.2 E key slot

Support PCIe and USB interface of this connector.

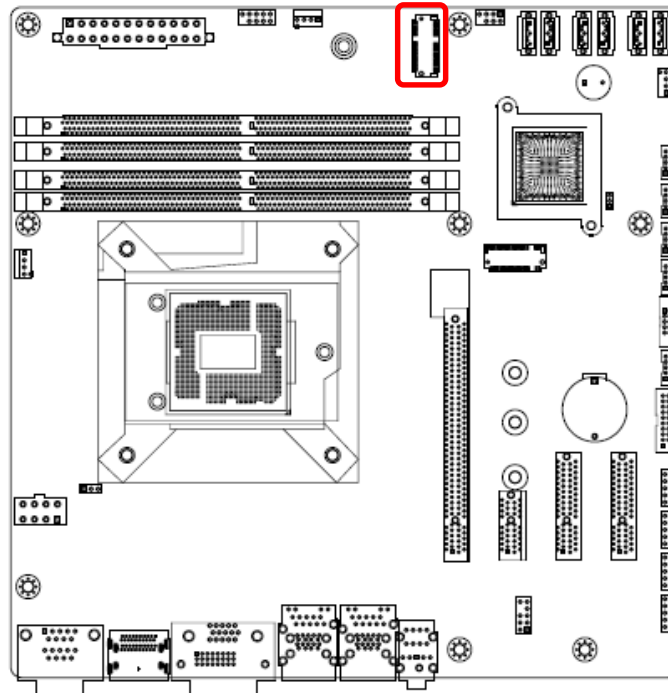

1.6 Jumpers

1.6.1 Clear CMOS (JCMOS1)

This jumper allows you to clear the Real Time Clock (RTC) RAM in CMOS. You can clear the CMOS memory of date, time, and system setup parameters by erasing the CMOS RTC RAM data. The onboard button cell battery powers the RAM data in CMOS, which includes system setup information such as system passwords.

To erase the RTC RAM:

1. Turn OFF the computer and unplug the power cord.
2. Remove the onboard battery.
3. Move the jumper cap from pins 1-2 (default) to pins 2-3. Keep the cap on pins 2-3 for about 5~10 seconds, then move the cap back to pins 1-2.
4. Re-install the battery.
5. Plug the power cord and turn ON the computer.
6. Hold down the key during the boot process and enter BIOS setup to re-enter data.



Except when clearing the RTC RAM, never remove the cap on CLRRTC jumper default position. Removing the cap will cause system boot failure!

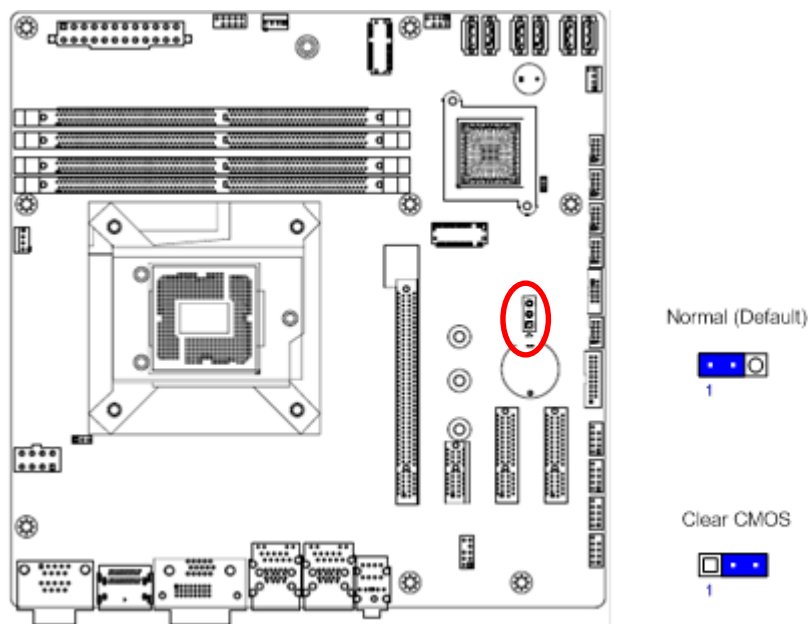

You do not need to clear the RTC when the system hangs due to overclocking. For system failure due to overclocking, use the C.P.R. (CPU Parameter Recall) feature. Shut down and reboot the system so the BIOS can automatically reset parameter settings to default values.

1.6.2 AT/ATX Power Mode Select (JPSON1)

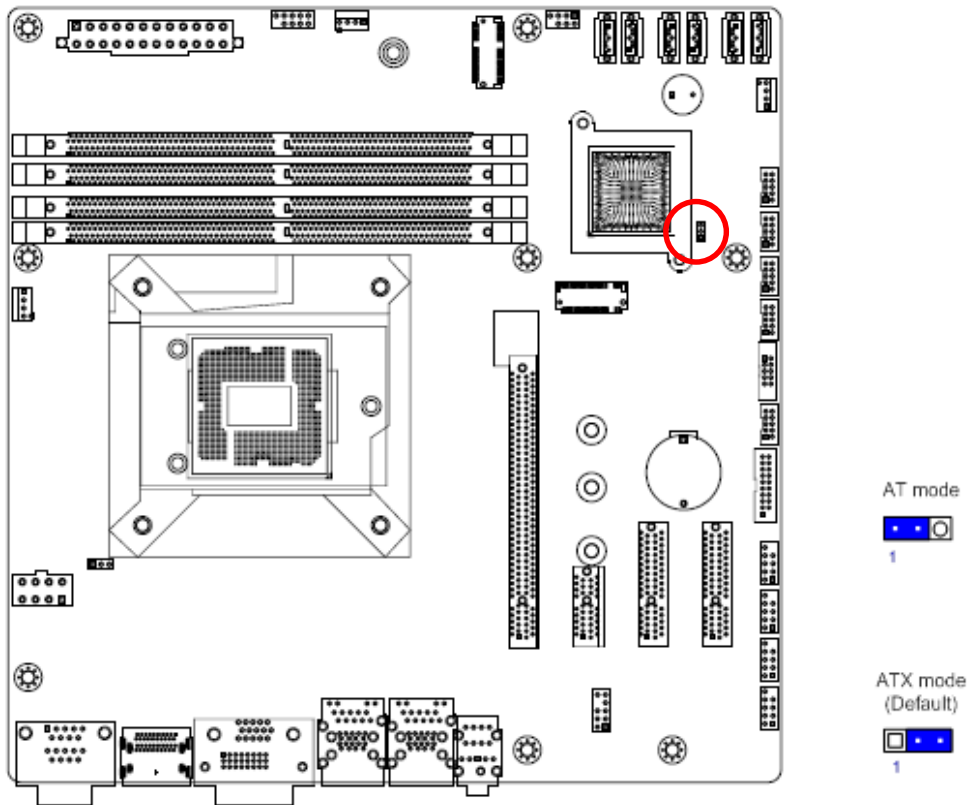

This jumper allows you to select ATX Mode or AT mode

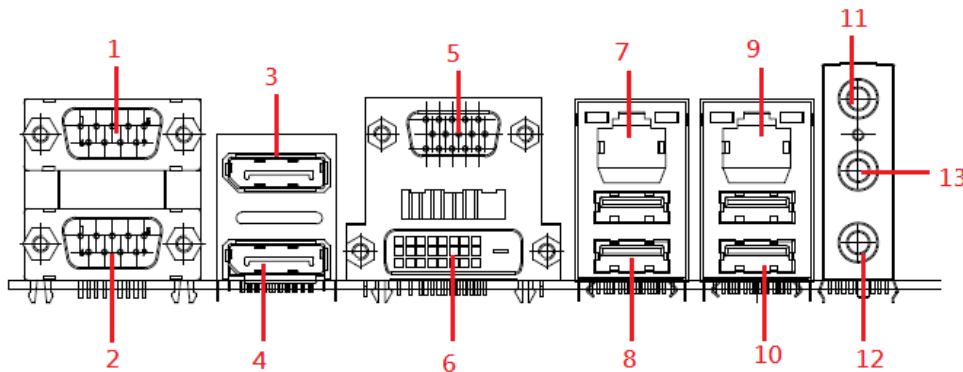

1.7 Connectors

1.7.1 Rear panel connectors

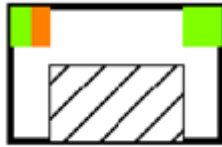

Item	Name	Function	Description												
1	COM1	Serial COM Port	The Serial COM port 1.												
2	COM2	Serial COM Port	The Serial COM port 2.												
3	DP1	Display Port	The DP port connector												
4	DP2	Display Port	The DP port connector												
5	VGA1	VGA Port	The VGA port connector												
6	DVI1	DVI-D port	The DVI-D port connector												
7	LAN1	Gigabit LAN (RJ-45) Connectors 	This port allows Gigabit connection to a Local Area Network (LAN) through a network hub. Refer to the table below for the LAN port LED indications.												
			<table border="1"> <thead> <tr> <th>Speed</th> <th>Left Speed</th> <th>Right Active</th> </tr> </thead> <tbody> <tr> <td>1G</td> <td>Green</td> <td>Green</td> </tr> <tr> <td>100</td> <td>Orange</td> <td>Green</td> </tr> <tr> <td>10</td> <td>N/A</td> <td>Green</td> </tr> </tbody> </table>	Speed	Left Speed	Right Active	1G	Green	Green	100	Orange	Green	10	N/A	Green
			Speed	Left Speed	Right Active										
			1G	Green	Green										
100	Orange	Green													
10	N/A	Green													
<table border="1"> <thead> <tr> <th>Speed</th> <th>Left Speed</th> <th>Right Active</th> </tr> </thead> <tbody> <tr> <td>1G</td> <td>Green</td> <td>Green</td> </tr> <tr> <td>100</td> <td>Orange</td> <td>Green</td> </tr> <tr> <td>10</td> <td>N/A</td> <td>Green</td> </tr> </tbody> </table>	Speed	Left Speed	Right Active	1G	Green	Green	100	Orange	Green	10	N/A	Green			
Speed	Left Speed	Right Active													
1G	Green	Green													
100	Orange	Green													
10	N/A	Green													
<table border="1"> <thead> <tr> <th>Speed</th> <th>Left Speed</th> <th>Right Active</th> </tr> </thead> <tbody> <tr> <td>1G</td> <td>Green</td> <td>Green</td> </tr> <tr> <td>100</td> <td>Orange</td> <td>Green</td> </tr> <tr> <td>10</td> <td>N/A</td> <td>Green</td> </tr> </tbody> </table>	Speed	Left Speed	Right Active	1G	Green	Green	100	Orange	Green	10	N/A	Green			
Speed	Left Speed	Right Active													
1G	Green	Green													
100	Orange	Green													
10	N/A	Green													
8	USB12	USB 3.1 Gen2 Connectors	Two port USB3.1 Gen2												
9	LAN2	Gigabit LAN (RJ-45) Connectors 	This port allows Gigabit connection to a Local Area Network (LAN) through a network hub. Refer to the table below for the LAN port LED indications.												
			<table border="1"> <thead> <tr> <th>Speed</th> <th>Left Speed</th> <th>Right Active</th> </tr> </thead> <tbody> <tr> <td>1G</td> <td>Green</td> <td>Green</td> </tr> <tr> <td>100</td> <td>Orange</td> <td>Green</td> </tr> <tr> <td>10</td> <td>N/A</td> <td>Green</td> </tr> </tbody> </table>	Speed	Left Speed	Right Active	1G	Green	Green	100	Orange	Green	10	N/A	Green
			Speed	Left Speed	Right Active										
			1G	Green	Green										
100	Orange	Green													
10	N/A	Green													
<table border="1"> <thead> <tr> <th>Speed</th> <th>Left Speed</th> <th>Right Active</th> </tr> </thead> <tbody> <tr> <td>1G</td> <td>Green</td> <td>Green</td> </tr> <tr> <td>100</td> <td>Orange</td> <td>Green</td> </tr> <tr> <td>10</td> <td>N/A</td> <td>Green</td> </tr> </tbody> </table>	Speed	Left Speed	Right Active	1G	Green	Green	100	Orange	Green	10	N/A	Green			
Speed	Left Speed	Right Active													
1G	Green	Green													
100	Orange	Green													
10	N/A	Green													
<table border="1"> <thead> <tr> <th>Speed</th> <th>Left Speed</th> <th>Right Active</th> </tr> </thead> <tbody> <tr> <td>1G</td> <td>Green</td> <td>Green</td> </tr> <tr> <td>100</td> <td>Orange</td> <td>Green</td> </tr> <tr> <td>10</td> <td>N/A</td> <td>Green</td> </tr> </tbody> </table>	Speed	Left Speed	Right Active	1G	Green	Green	100	Orange	Green	10	N/A	Green			
Speed	Left Speed	Right Active													
1G	Green	Green													
100	Orange	Green													
10	N/A	Green													

Item	Name	Function	Description
10	USB34	USB 3.0 Connectors	Two port USB3.1 Gen2
11	AUDIO1	Line-in port (Light blue)	This port connects a tape, CD, DVD player, or other audio sources.
12	AUDIO1	Microphone port (Pink)	This port connects a microphone.
13	AUDIO1	Line-out port (Lime)	This port connects a headphone or a speaker. In 4-channel, 6-channel, and 8-channel configuration, the function of this port becomes Front Speaker Out.

1.7.2 CPU and System fan connectors (CPU_FAN1, SYS_FAN1, SYS_FAN2)

The fan connectors support cooling fans of 280mA (3.36 W max.) at 4800rpm or a total of 1A~2.22A (26.64W max.) at +12V. Connect the fan cables to the fan connectors on the motherboard, making sure that the black wire of each cable matches the ground pin of the connector.

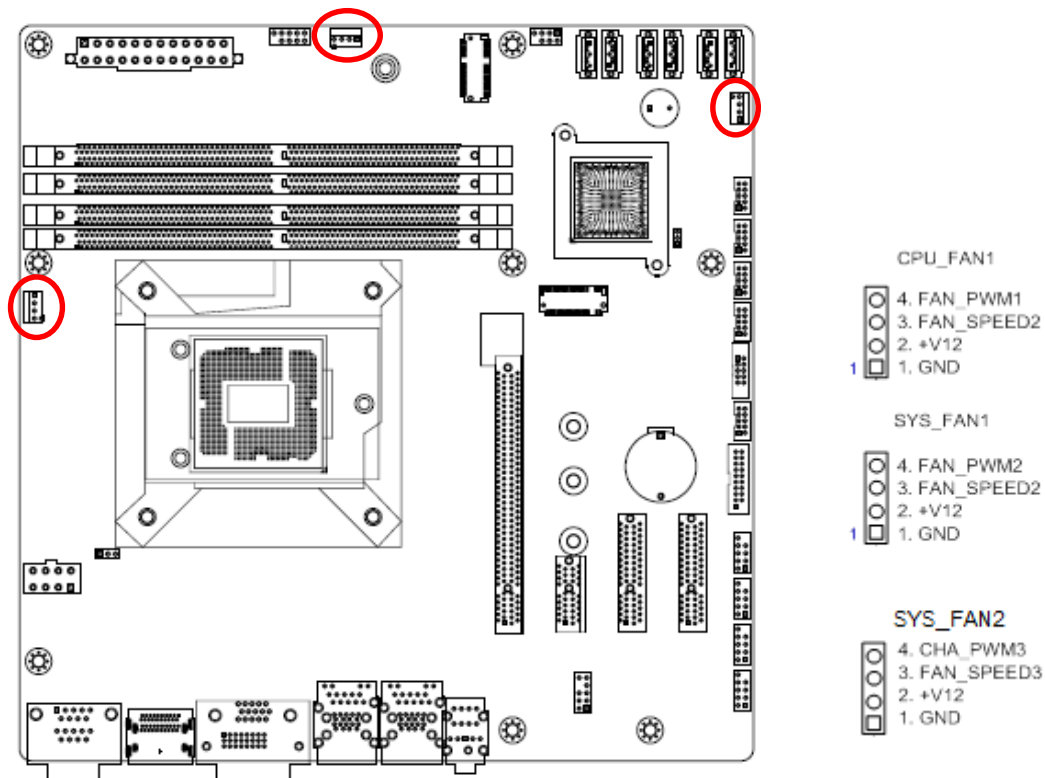

Do not forget to connect the fan cables to the fan connectors. Insufficient air flow inside the system may damage the motherboard components. These are not jumpers! DO NOT place jumper caps on the fan connectors.

1.7.3 System Panel (F_PANEL1)

This connector is for a chassis-mounted front panel. The functions are as following.

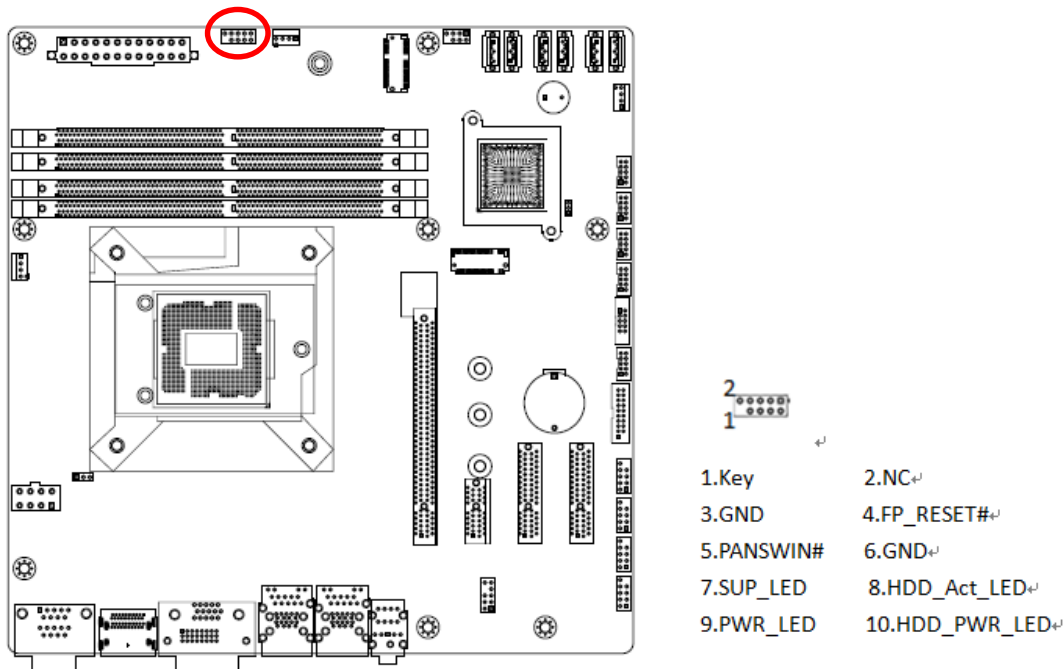

- **ATX Power Button/Soft-off Button (Pin 3-5)**

This 2-pin connector is for the system power button. Pressing the power button turns the system on or puts the system in sleep or soft-off mode depending on the BIOS settings. Pressing the power switch and holding it for more than four seconds while the system is ON turns the system OFF.

- **Reset Button (Pin 4-6)**

This 2-pin connector is for the chassis-mounted reset button for system reboot without turning off the system power.

- **Power LED (Pin 7-9)**

This 2-pin connector is for the system power LED. Connect the chassis power LED cable to this connector. The system power LED lights up when you turn on the system power, and blinks when the system is in sleep mode.

- **Hard Disk Drive Activity LED (Pin 8-10)**

This 2-pin connector is for the HDD Activity LED. Connect the HDD Activity LED cable to this connector. The IDE LED lights up or flashes when data is read from or written to the HDD.

1.7.4 ATX power connectors (EATXPWR1 & ATX12V1)

The connector is for ATX power supply plugs. The power supply plugs are designed to fit these connectors in only one orientation. Find the proper orientation and push down firmly until the connectors completely fit.

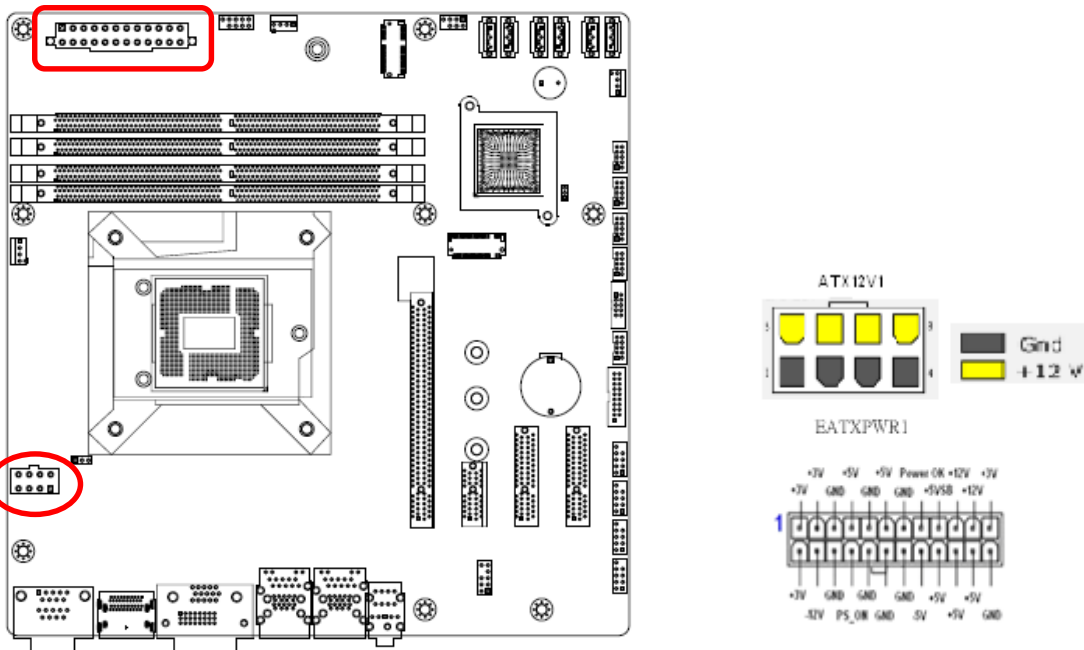

- Use of a PSU with a higher power output is recommended when configuring a system with more power-consuming devices. The system may become unstable or may not boot up if the power is inadequate.
- Make sure that your power supply unit (PSU) can provide at least the minimum power required by your system. See the table below for details.

1.7.5 Serial Port connectors (COM3~6)

This connector is for a serial (COM) port. Connect the serial port module cable to this connector, then install the module to a slot opening at the back of the system chassis.

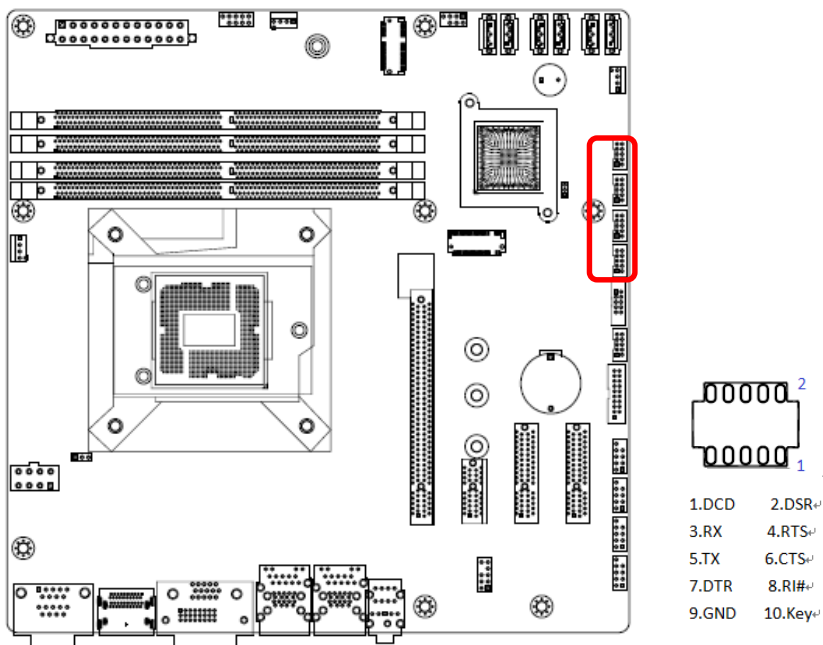

1.7.6 Serial ATA Connector (SATA1~6)

SATA 1~6 support SATA 3.0. and SATA 1 is shared by M.2 key M slot. These connectors are for the Serial ATA signal cables for Serial ATA hard disk drives.

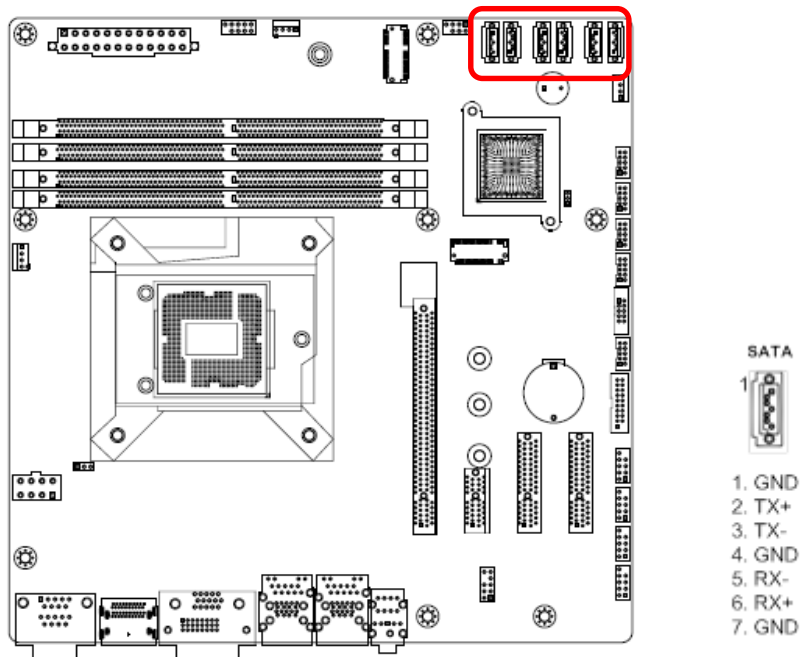

1.7.7 USB connectors (USB78, USB910, USB1112, USB13)

These connectors are for USB 2.0 ports. Connect the optional USB module cable to any of these connectors, then install the module to a slot opening at the back of the system chassis. These USB connectors comply with USB 2.0 specification that supports up to 480 Mbps connection speed.

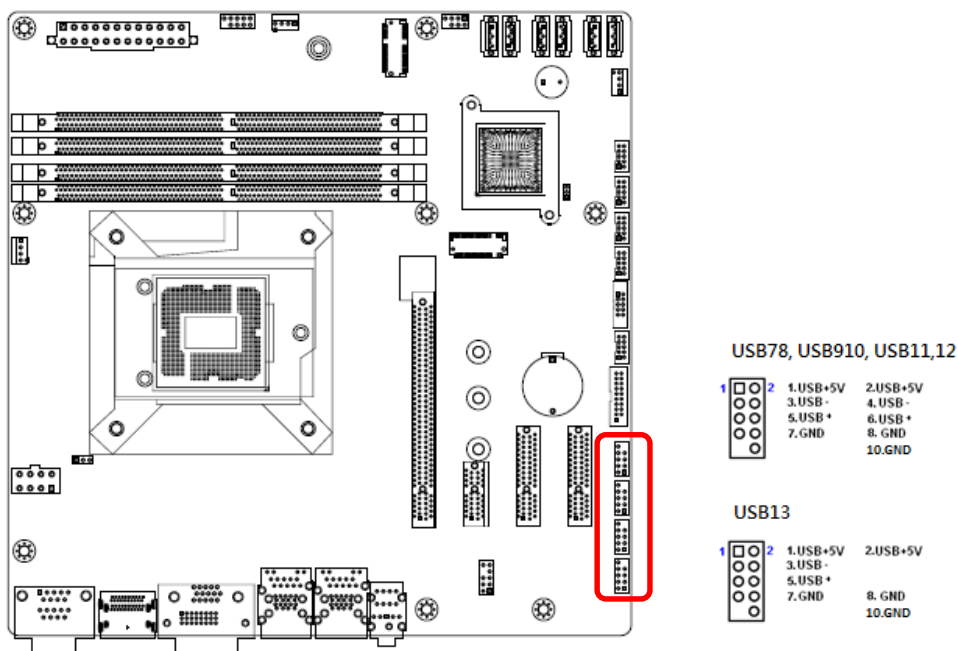

Never connect a 1394 cable to the USB connectors. Doing so will damage the motherboard!



The USB module is purchased separately.

1.7.8 USB3.0 connector (USB56)

This connector provides 2 port USB3.1 Gen1 port. Connect the optional USB module cable to any of these connectors, then install the module to a slot opening at the back of the system chassis. These USB connectors comply with USB 3.1 Gen1 specification that supports up to 5Gbps connection speed.

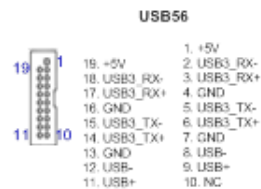
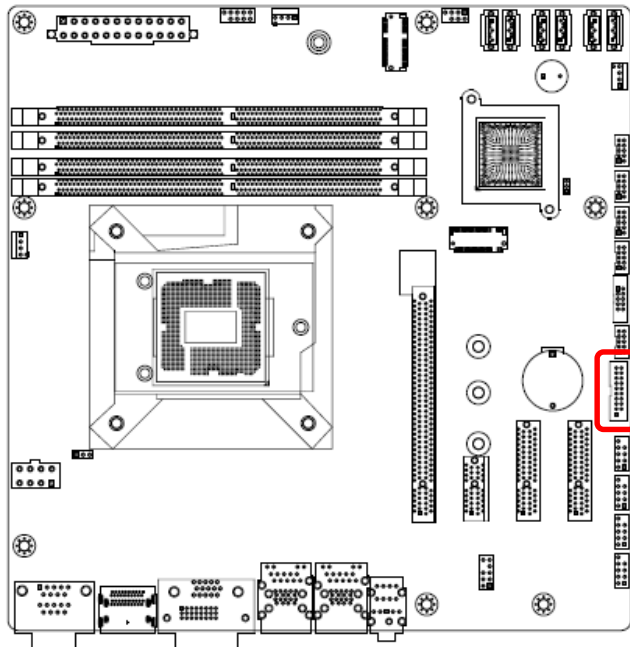

1.7.9 8 bit GPIO header (JDIO1)

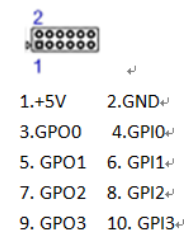
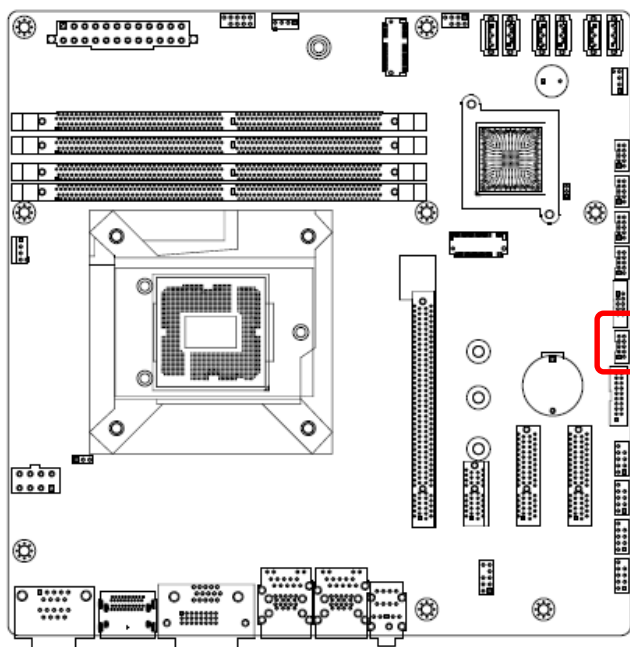

1.7.10 Front Audio connector (FP_AUDIO1)

This connector is for a chassis-mounted front panel audio I/O module that supports either HD Audio or legacy AC '97 (optional) audio standard.

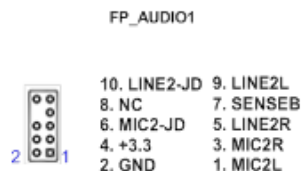
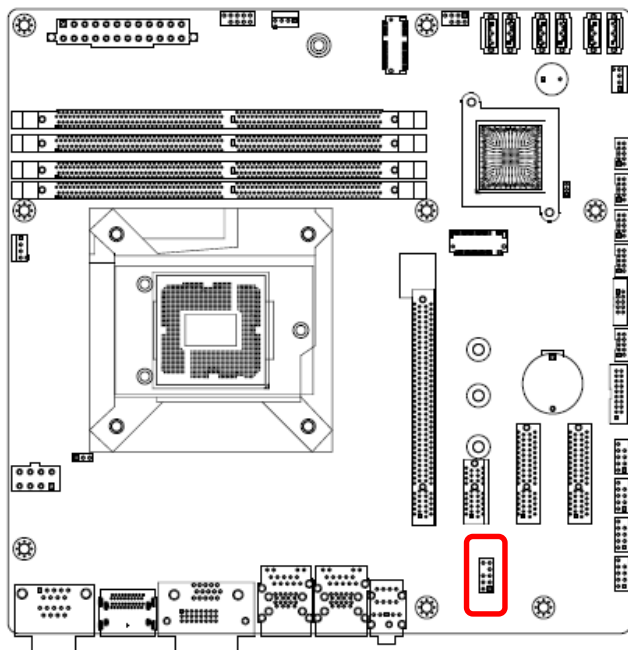

1.7.11 SM bus connector (JSMB1)

For RD develop use only.

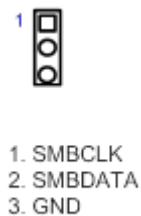
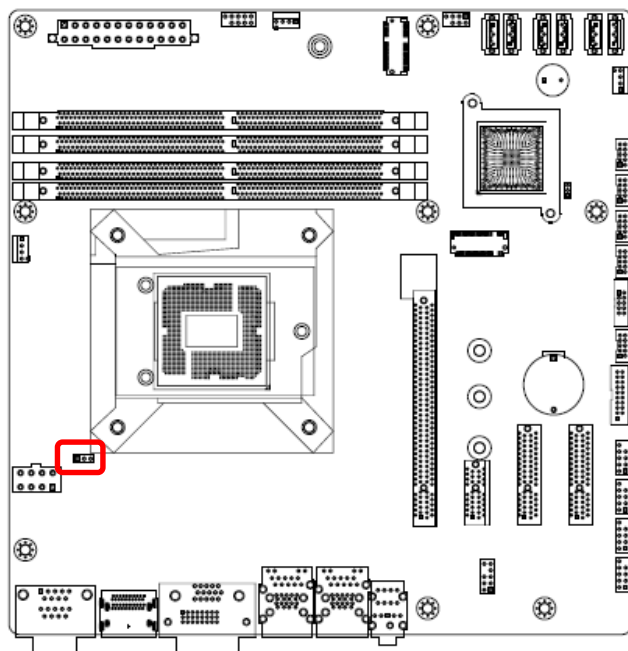

1.7.12 LPC connector (JLPC1)

For RD develop use only.

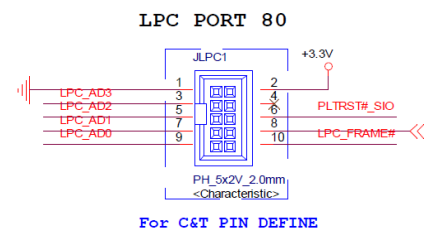
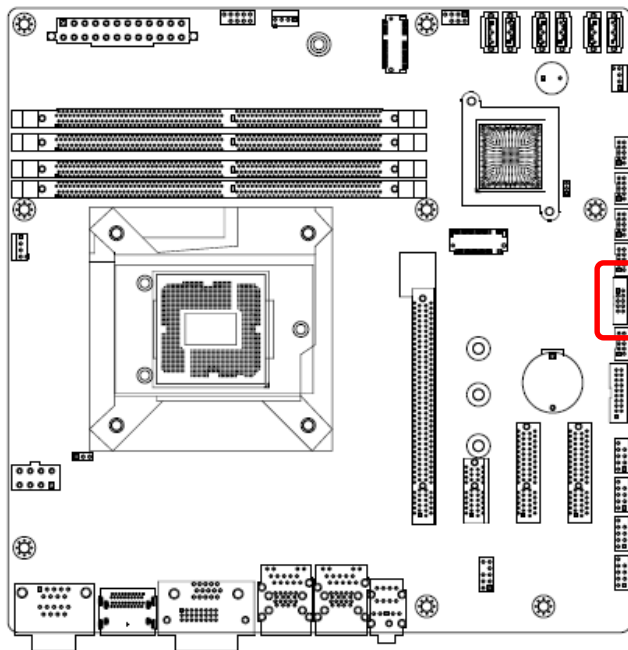

1.7.13 SPI connector (SPI1)

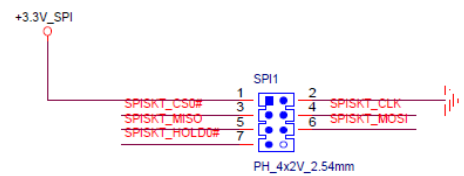
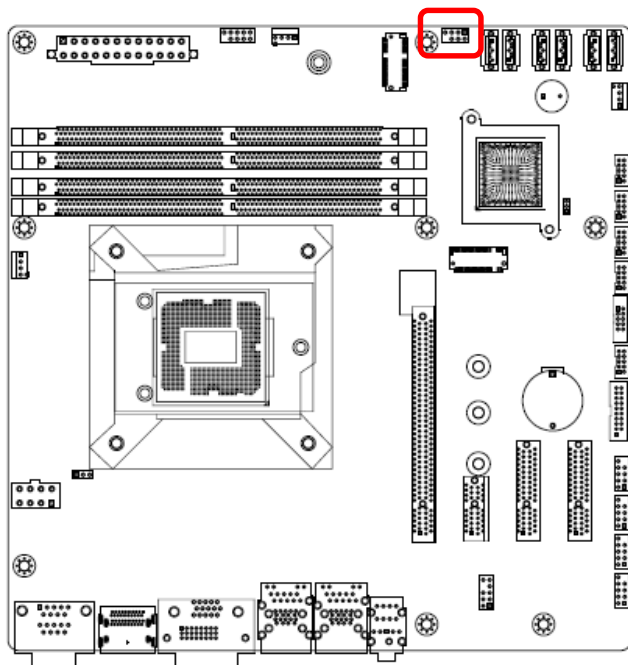

Chapter 2

BIOS Setup

This chapter tells how to change the system settings through the BIOS Setup menus. Detailed descriptions of the BIOS parameters are also provided.

2.1 General Features

General Features		
Item	Description	Remarks
BIOS Sign On	**** CT-MCL01 BIOS VX.XX (MM/DD/YYYY) ****	
Boot Block	<p>BIOS Boot Block function support When BIOS is crash, BIOS can be recovered according below steps.</p> <ol style="list-style-type: none"> 1. Put the original BIOS file in the USB disk, and install the USB disk into the system. 2. Boot the system, and system will boot to recovery page. 3. Choose recovery item to start BIOS recovery action. 4. BIOS recover name is "BIOS.BIN". 	This feature is used to update a BIOS image without the need to boot to an operating system
Flash Utility	BIOS update through Flash utility in UEFI	
Onboard Devices Control	Enable/Disable onboard devices (VGA, NIC, Audio, USB, SATA, and COM, LPT) with BIOS Setup options.	
System Info	System information (File name, BIOS release date, product name) display in BIOS Setup	
Debug mode	Support LPC 80 port for debug	
PLED	PLED S0:Light S3:Blinking Delay4s,S4,S5,DOS off :Dark for single color LED	
Clear CMOS	Show warning message and stop at post screen until press <F1> skip, or <ESC> enter setup.	

2.2 POST Error Beep Requirements

POST Error Beep Requirements		
Item	Description	Remarks
System	System is OK (After enable VGA at post)	One short beep
Memory	System memory error/not installed.	One long beep
VGA	Graphics card error/not installed graphics card	Five long beeps then still boot
USB	When plug device in USB port or plug out.	One short beep
Boot Block	When run boot block.	Two short beep

2.3 BIOS Hotkey Requirements

The table below lists the BIOS hotkey requirements.

BIOS Hotkey Requirements	
	Hot Key
Enter BIOS Setup	DEL / ESC

2.4 South Bridge Features

POST Error Beep Requirements		
Item	Description	Remarks
PCI Express	<ul style="list-style-type: none"> • PCIE LAN by root port control enable/disable. • PCIE RAID, LAN onboard devices must included option ROM and add control item in BIOS 	
SATA & RAID	<ul style="list-style-type: none"> • Supports RAID and AHCI configuration and can operate in both legacy and native modes. • Support over 2T capacity HDD. 	
PCI Bus Interface	<ul style="list-style-type: none"> • Onboard PCI LAN can enable/disable by BIOS. • PCI RAID, LAN onboard devices must included option ROM and add control item in BIOS 	
USB Interface	<ul style="list-style-type: none"> • Support USB 2.0 (High Speed) • Support USB 3.0 (Super High Speed) • Per-Port-Disable /Enable Capability • Support Keyboard/Mouse wake-up from sleeping S3/S4 by OS. • Support legacy Keyboard/Mouse software • Support legacy Keyboard Hot-Plug function • Support maximal 8 USB devices in Boot Option Priority. 	
Real-Time Clock	<ul style="list-style-type: none"> • System can be wake up from S5 by RTC. • User can set day and time to active RTC function. • RTC time can't be clear when short RTCRST# • RTC works even power has been loss. 	

2.5 ACPI function

Wake-up Devices and Events		
These devices/events can wake up the computer...	from this state	Remarks
PCIE LAN	S3, S4, S5	<ul style="list-style-type: none"> The LAN adapter monitors network traffic at the Media Independent Interface Supports LAN wake capabilities with ACPI by Ping or Magic Packet S3-S4 by OS S5 by BIOS item control
Intel GBE	S3, S4, S5	<ul style="list-style-type: none"> S3-S5 BIOS control.
PME# signal	S3, S4, S5	<ul style="list-style-type: none"> PME# signal on the PCI bus S3-S4 by OS control S5 by BIOS item control
Wake# signal	S3, S4, S5	<ul style="list-style-type: none"> WAKE# signal on the PCI Express bus S3-S4 by OS control S5 by BIOS item control
Power switch	S3, S4, S5	
RTC alarm	S5	
USB	S3,S4	<ul style="list-style-type: none"> Press any key or move can wake up system S3,S4 by OS control
Notes:		
<ul style="list-style-type: none"> Does not apply to shutdown system by delay 4 seconds. 		

Sleep Wake State Source	S1	S3	S4	S5
PCIE LAN	x	⊙	⊙	△
Gbe LAN	x	△	△	△
PME#/WAKE#	x	⊙	⊙	△
Power Button	x	⊙	⊙	⊙
RTC Alarm	x	x	x	△/⊙
USB	x	⊙	⊙	x

x : No Support. △ : Controlled by BIOS Item. ⊙ : Controlled by OS/Driver.

2.6 OEM full screen logo

BIOS support the following format OEM full screen logo and user can insert it by utility that provided from BIOS vendor.

BMP :800x600 24bits, JPEG:800x600 24bits, PCX:800x600 24bits

2.7 SuperIO Feature Support

SuperIO Feature Support		
Item	Description	Remarks
Serial Port	<ul style="list-style-type: none"> Each UART includes a 128-byte send/receive FIFO, a programmable baud rate generator, complete modem-control capability, and a processor interrupt system. The UART supports legacy speeds up to 115.2K bps as well as even higher baud rates of 460K, or 921K bps to support higher speed modems. Default COM1=3F8/IRQ4,COM2=2F8/IRQ3,COM3=3E8/IRQ5,COM4=2E8/IRQ5,COM5=2E0/IRQ10,COM6=3E0/IRQ10 	
Case Open	<ul style="list-style-type: none"> The purpose of Case open function is used to detect whether the computer case is opened. This feature must be able to function even when there is no 3VSB power. Once the case is opened, the beep will be active at next boot. The buzzer works and show error message will stop at post screen by press Del until user disables the function in BIOS setup. 	
Watchdog	<ul style="list-style-type: none"> BIOS provide 0 to 255 seconds or minutes watchdog reset function. If user set to 0, it will disable watchdog function. If user writes any non-zero value to this register causes the counter to load this value into the Watchdog Timer counter and start counting down. System will be reset if Watch Dog Timer counts down to zero. 	
Brightness Control	<ul style="list-style-type: none"> BIOS provide DC output to control panel brightness. The brightest DC output generally. But it still dependent on hardware design or inverter of panel. 	
Smart Fan	<ul style="list-style-type: none"> BIOS provide CPU and System smart fan function for noise consideration. Depend on Super IO support Manual, Thermal Cruise, SMART FAN IV and Disable mode. 	

2.8 Boot Option

Boot Option		
Item	Description	Remarks
Setup Prompt Timeout	The item controls the delay time (in seconds) in the POST screen until user press DEL / ESC key to enter BIOS setup menu. The range for the value is from 1 to 65535.	
Quiet Boot	When Quiet Boot is Disabled, the BIOS information will be shown in the POST screen. When Quiet Boot is Enabled, the Black Logo will be shown in the POST screen.	

2.9 Trust Computing

Trust Computing		
Item	Description	Remarks
TCG/TPM Support	<ul style="list-style-type: none"> Support TPM/TCG 2.0 This is the main item to control whether the TPM function is supported or not. 	
Execute TPM Command	<ul style="list-style-type: none"> Activate or Deactivate command to TPM Three commands are supported, Don't Change, Enabled, and Disabled. 	
Clearing the TPM	<ul style="list-style-type: none"> Clearing the TPM is the process of returning the TPM to factory defaults. It is possible the platform owner will change when in this state. 	

2.10 Main Setup

This menu gives you an overview of the general system specifications. The BIOS automatically detects the items in this menu. Use this menu for basic system configurations, such as time, date etc.



BIOS Information

Displays the auto-detected BIOS information.

- **System Date**

The date format is <Date>,<Month>,<Day>,<Year>.

- **System Time**

The time format is <Hour>,<Minute>,<Second>.

2.11 Advanced BIOS Setup

Select the Advanced tab from the setup screen to enter the Advanced BIOS Setup screen.

You can select any of the items in the left frame of the screen, such as Chipset configuration, to go to the sub menu for that item. You can display an Advanced BIOS Setup option by highlighting it using the <Arrow> keys. All Advanced BIOS Setup options are described in this section. The Advanced BIOS Setup screen is shown below. The sub menus are described on the following pages.

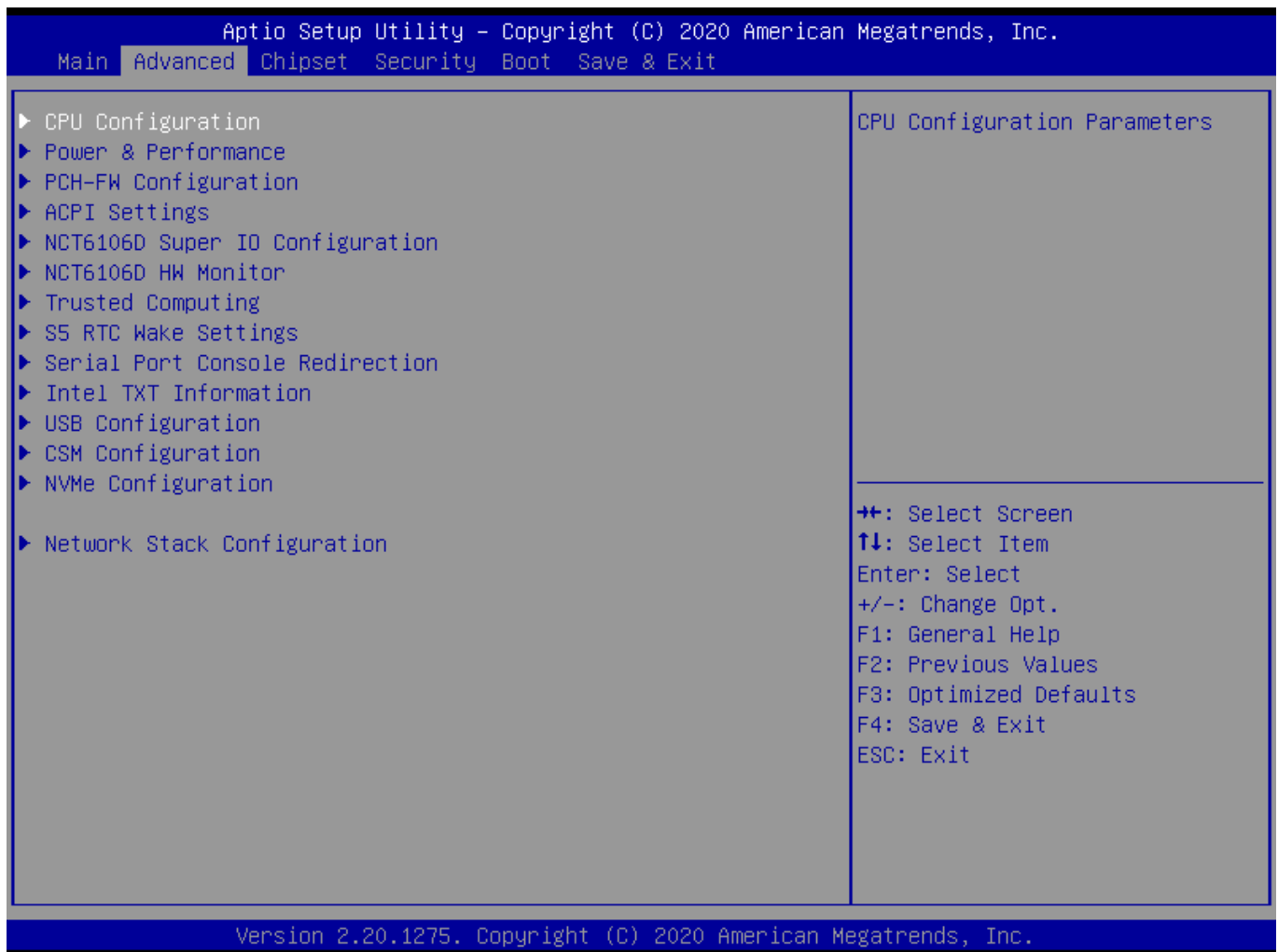

Take caution when changing the settings of the Advanced menu items. Incorrect field values can cause the system to malfunction.

2.11.1 CPU Configuration

Aptio Setup Utility - Copyright (C) 2020 American Megatrends, Inc.

Advanced

CPU Configuration		Enable/Disable Software Guard Extensions (SGX)
Type	Intel(R) Pentium(R) Gold G5400 CPU @ 3.70GHz	
ID	0x906EB	
Microcode Revision	CA	
Speed	3700 MHz	
L1 Data Cache	32 KB x 2	
L1 Instruction Cache	32 KB x 2	
L2 Cache	256 KB x 2	
L3 Cache	4 MB	
L4 Cache	N/A	
VMX	Supported	
SMX/TXT	Not Supported	
Software Guard Extensions (SGX)	[Software Controlled]	
Select Owner EPOCH input type	[No Change in Owner EPOCHs]	
Intel (VMX) Virtualization Technology	[Enabled]	
Active Processor Cores	[All]	

++: Select Screen
 ↑↓: Select Item
 Enter: Select
 +/-: Change Opt.
 F1: General Help
 F2: Previous Values
 F3: Optimized Defaults
 F4: Save & Exit
 ESC: Exit

Version 2.20.1275. Copyright (C) 2020 American Megatrends, Inc.

2.11.2 Power & Performance

Aptio Setup Utility - Copyright (C) 2020 American Megatrends, Inc.

Advanced

Power & Performance	CPU - Power Management Control Options
▶ CPU - Power Management Control	
▶ GT - Power Management Control	

++: Select Screen
 ↑↓: Select Item
 Enter: Select
 +/-: Change Opt.
 F1: General Help
 F2: Previous Values
 F3: Optimized Defaults
 F4: Save & Exit
 ESC: Exit

Version 2.20.1275. Copyright (C) 2020 American Megatrends, Inc.

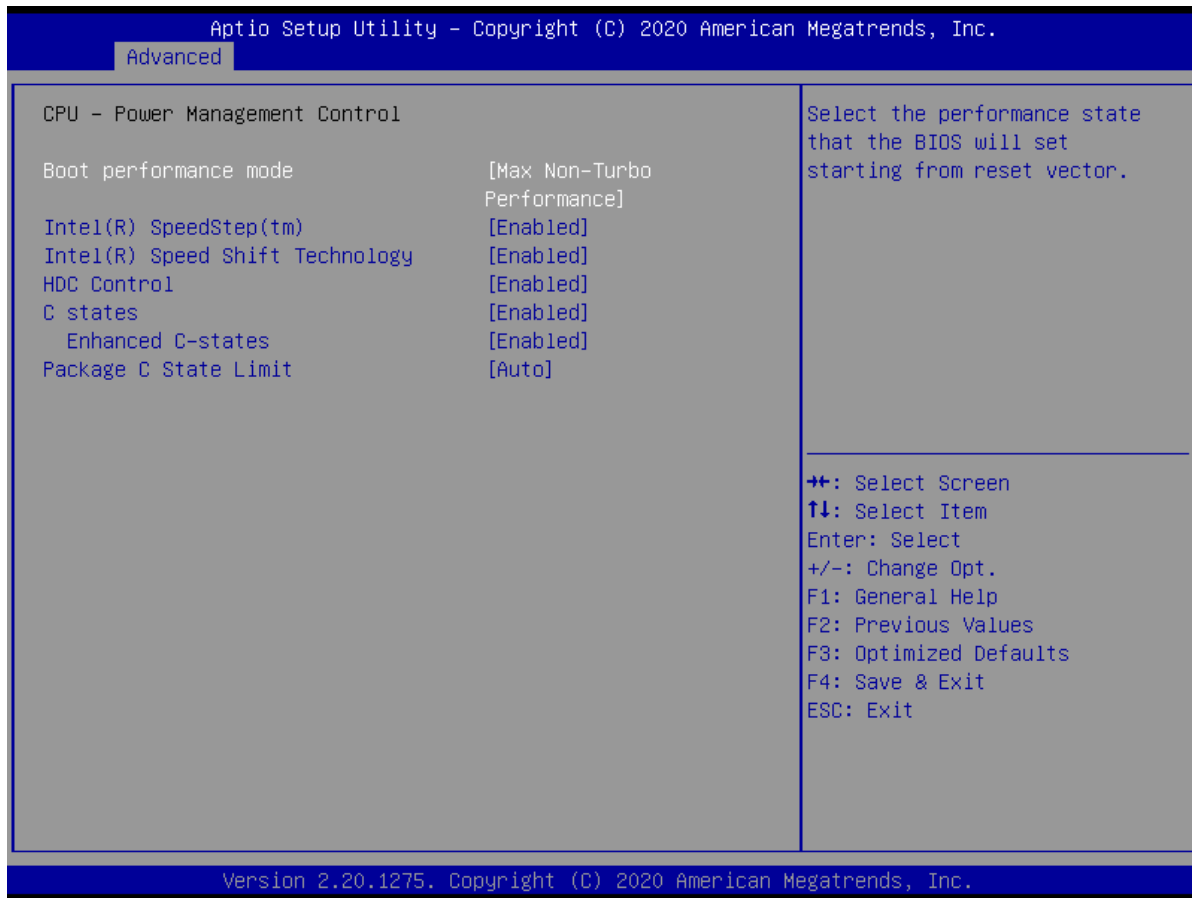

2.11.3 PCH-FW Configuration

Aptio Setup Utility - Copyright (C) 2020 American Megatrends, Inc.

Advanced

ME Firmware Version	12.0.49.1534	When Disabled ME will be put into ME Temporarily Disabled Mode.
ME Firmware Mode	Normal Mode	
ME Firmware SKU	Corporate SKU	
ME Firmware Status 1	0x90000255	
ME Firmware Status 2	0x89108106	
ME State	[Enabled]	

++: Select Screen
 ↑↓: Select Item
 Enter: Select
 +/-: Change Opt.
 F1: General Help
 F2: Previous Values
 F3: Optimized Defaults
 F4: Save & Exit
 ESC: Exit

Version 2.20.1275. Copyright (C) 2020 American Megatrends, Inc.

2.11.4 ACPI Settings

Aptio Setup Utility - Copyright (C) 2020 American Megatrends, Inc.

Advanced

ACPI Settings		Enables or Disables System ability to Hibernate (OS/S4 Sleep State). This option may not be effective with some operating systems.
Enable Hibernation	[Enabled]	
ACPI Sleep State	[S3 (Suspend to RAM)]	
Lock Legacy Resources	[Disabled]	
S3 Video Repost	[Disabled]	
PCIe# Wake from S5	[Disabled]	

++: Select Screen
 ↑↓: Select Item
 Enter: Select
 +/-: Change Opt.
 F1: General Help
 F2: Previous Values
 F3: Optimized Defaults
 F4: Save & Exit
 ESC: Exit

Version 2.20.1275. Copyright (C) 2020 American Megatrends, Inc.

2.11.5 NCT6106D Super IO Configuration

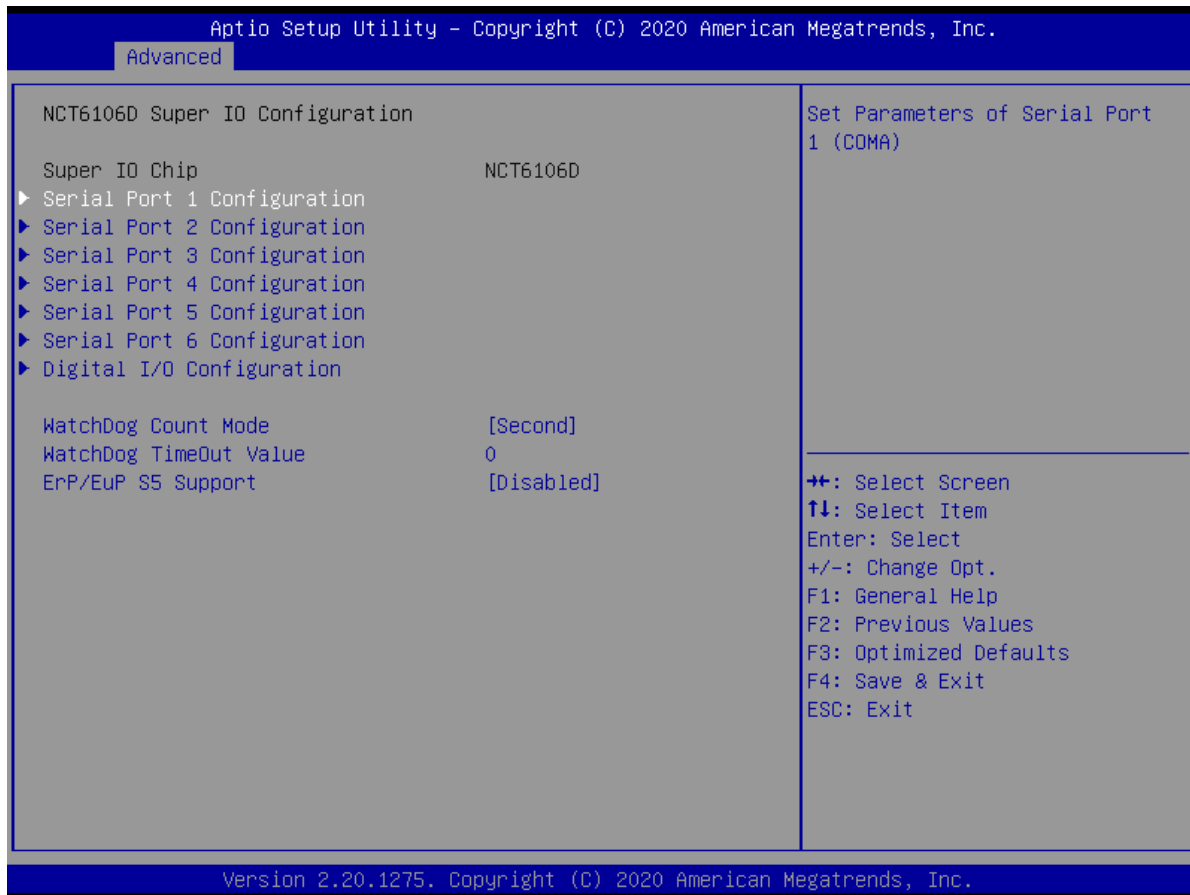

Aptio Setup Utility - Copyright (C) 2020 American Megatrends, Inc.

Advanced

<p>Serial Port 2 Configuration</p> <p>Serial Port [Enabled] Device Settings IO=2F8h; IRQ=3;</p> <p>Change Settings [Auto] COM Mode Select [RS232]</p>	<p>Enable or Disable Serial Port (COM)</p> <hr/> <p> ++: Select Screen ↑↓: Select Item Enter: Select +/-: Change Opt. F1: General Help F2: Previous Values F3: Optimized Defaults F4: Save & Exit ESC: Exit </p>
---	--

Version 2.20.1275. Copyright (C) 2020 American Megatrends, Inc.

Aptio Setup Utility - Copyright (C) 2020 American Megatrends, Inc.

Advanced

<p>Serial Port 3 Configuration</p> <p>Serial Port [Enabled] Device Settings IO=3E8h; IRQ=5;</p> <p>Change Settings [Auto]</p>	<p>Enable or Disable Serial Port (COM)</p> <hr/> <p> ++: Select Screen ↑↓: Select Item Enter: Select +/-: Change Opt. F1: General Help F2: Previous Values F3: Optimized Defaults F4: Save & Exit ESC: Exit </p>
--	--

Version 2.20.1275. Copyright (C) 2020 American Megatrends, Inc.

Aptio Setup Utility - Copyright (C) 2020 American Megatrends, Inc.

Advanced

<p>Serial Port 4 Configuration</p> <p>Serial Port [Enabled]</p> <p>Device Settings IO=2E8h; IRQ=5;</p> <p>Change Settings [Auto]</p>	<p>Enable or Disable Serial Port (COM)</p> <hr/> <p> ++: Select Screen ↑↓: Select Item Enter: Select +/-: Change Opt. F1: General Help F2: Previous Values F3: Optimized Defaults F4: Save & Exit ESC: Exit </p>
--	--

Version 2.20.1275. Copyright (C) 2020 American Megatrends, Inc.

Aptio Setup Utility - Copyright (C) 2020 American Megatrends, Inc.

Advanced

<p>Serial Port 5 Configuration</p> <p>Serial Port [Enabled]</p> <p>Device Settings IO=2E0h; IRQ=10;</p> <p>Change Settings [Auto]</p>	<p>Enable or Disable Serial Port (COM)</p> <hr/> <p> ++: Select Screen ↑↓: Select Item Enter: Select +/-: Change Opt. F1: General Help F2: Previous Values F3: Optimized Defaults F4: Save & Exit ESC: Exit </p>
---	--

Version 2.20.1275. Copyright (C) 2020 American Megatrends, Inc.

Aptio Setup Utility - Copyright (C) 2020 American Megatrends, Inc.

Advanced

<p>Serial Port 6 Configuration</p> <p>Serial Port [Enabled]</p> <p>Device Settings IO=3E0h; IRQ=10;</p> <p>Change Settings [Auto]</p>	<p>Enable or Disable Serial Port (COM)</p> <hr/> <p> ++: Select Screen ↑↓: Select Item Enter: Select +/-: Change Opt. F1: General Help F2: Previous Values F3: Optimized Defaults F4: Save & Exit ESC: Exit </p>
---	--

Version 2.20.1275. Copyright (C) 2020 American Megatrends, Inc.

Aptio Setup Utility - Copyright (C) 2020 American Megatrends, Inc.

Advanced

<p>Digital I/O Configuration</p> <p>Digital I/O Pin 1 [Input]</p> <p>Digital I/O Pin 2 [Input]</p> <p>Digital I/O Pin 3 [Input]</p> <p>Digital I/O Pin 4 [Input]</p> <p>Digital I/O Pin 5 [Input]</p> <p>Digital I/O Pin 6 [Input]</p> <p>Digital I/O Pin 7 [Input]</p> <p>Digital I/O Pin 8 [Input]</p>	<p>Configure Digital I/O Pin.</p> <hr/> <p> ++: Select Screen ↑↓: Select Item Enter: Select +/-: Change Opt. F1: General Help F2: Previous Values F3: Optimized Defaults F4: Save & Exit ESC: Exit </p>
--	---

Version 2.20.1275. Copyright (C) 2020 American Megatrends, Inc.

2.11.6 NCT6106D HW Monitor

Aptio Setup Utility - Copyright (C) 2020 American Megatrends, Inc.

Advanced

PC Health Status ▶ Smart Fan SYS Temperature : +29°C CPU Temperature (PECI) : +47°C SYS_FAN1 Speed : N/A CPU_FAN1 Speed : 4440 RPM SYS_FAN2 Speed : N/A VCORE : +1.080 V +12V : +12.000 V +5V : +5.056 V +5V_DUAL : +5.056 V AVCC : +3.344 V 3VSB : +3.280 V 3VCC : +3.344 V VBAT : +3.040 V	Smart Fan function page ++: Select Screen ↑↓: Select Item Enter: Select +/-: Change Opt. F1: General Help F2: Previous Values F3: Optimized Defaults F4: Save & Exit ESC: Exit
--	---

Version 2.20.1275. Copyright (C) 2020 American Megatrends, Inc.

Aptio Setup Utility - Copyright (C) 2020 American Megatrends, Inc.

Advanced

Smart Fan Smart Fan Function [Enabled] ▶ Smart Fan Mode Configuration	Smart Fan Function Enable/Disable ++: Select Screen ↑↓: Select Item Enter: Select +/-: Change Opt. F1: General Help F2: Previous Values F3: Optimized Defaults F4: Save & Exit ESC: Exit
---	--

Version 2.20.1275. Copyright (C) 2020 American Megatrends, Inc.

Aptio Setup Utility - Copyright (C) 2020 American Megatrends, Inc.

Advanced

Smart Fan Mode Configuration		SYS Smart Fan1 Mode
SYS Smart Fan1 Mode	[Manual Mode]	
SYS expect PWM Output Voltage	255	
CPU Smart Fan1 Mode	[Manual Mode]	
CPU expect PWM Output Voltage	255	
SYS Smart Fan2 Mode	[Manual Mode]	
SYS expect PWM Output Voltage	255	

++: Select Screen
 ↑↓: Select Item
 Enter: Select
 +/-: Change Opt.
 F1: General Help
 F2: Previous Values
 F3: Optimized Defaults
 F4: Save & Exit
 ESC: Exit

Version 2.20.1275. Copyright (C) 2020 American Megatrends, Inc.

2.11.7 Trusted Computing

Aptio Setup Utility - Copyright (C) 2020 American Megatrends, Inc.

Advanced

TPM20 Device Found		Enables or Disables BIOS support for security device. O.S. will not show Security Device. TCG EFI protocol and INT1A interface will not be available.
Firmware Version:	5.63	
Vendor:	IFX	
Security Device Support	[Enable]	
Active PCR banks	SHA-1,SHA256	
Available PCR banks	SHA-1,SHA256	
SHA-1 PCR Bank	[Enabled]	
SHA256 PCR Bank	[Enabled]	
Pending operation	[None]	
Platform Hierarchy	[Enabled]	
Storage Hierarchy	[Enabled]	
Endorsement Hierarchy	[Enabled]	
TPM2.0 UEFI Spec Version	[TCG_2]	
Physical Presence Spec Version	[1.3]	
TPM 20 InterfaceType	[TIS]	

++: Select Screen
 ↑↓: Select Item
 Enter: Select
 +/-: Change Opt.
 F1: General Help
 F2: Previous Values
 F3: Optimized Defaults
 F4: Save & Exit
 ESC: Exit

Version 2.20.1275. Copyright (C) 2020 American Megatrends, Inc.

2.11.8 S5 RTC Wake Setting

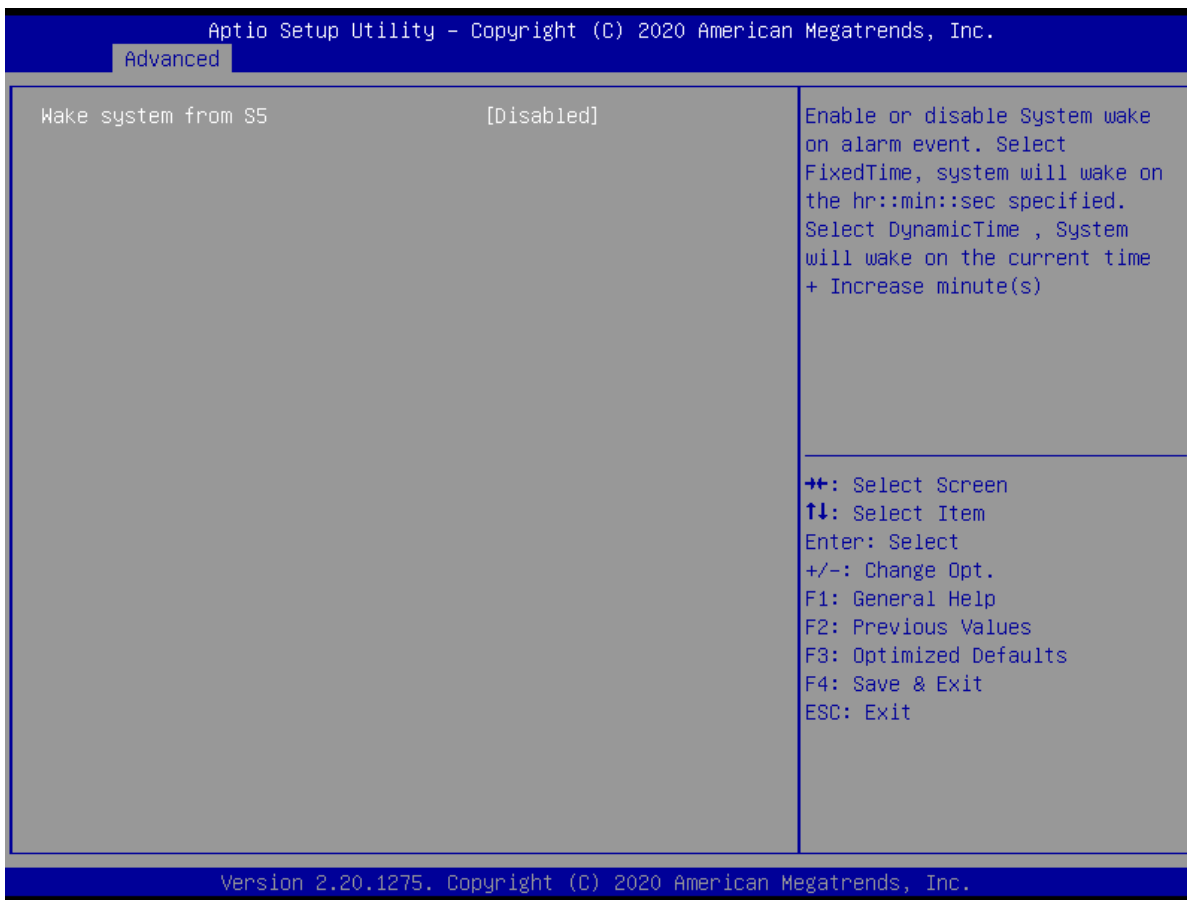

2.11.9 Serial Port Console Redirection

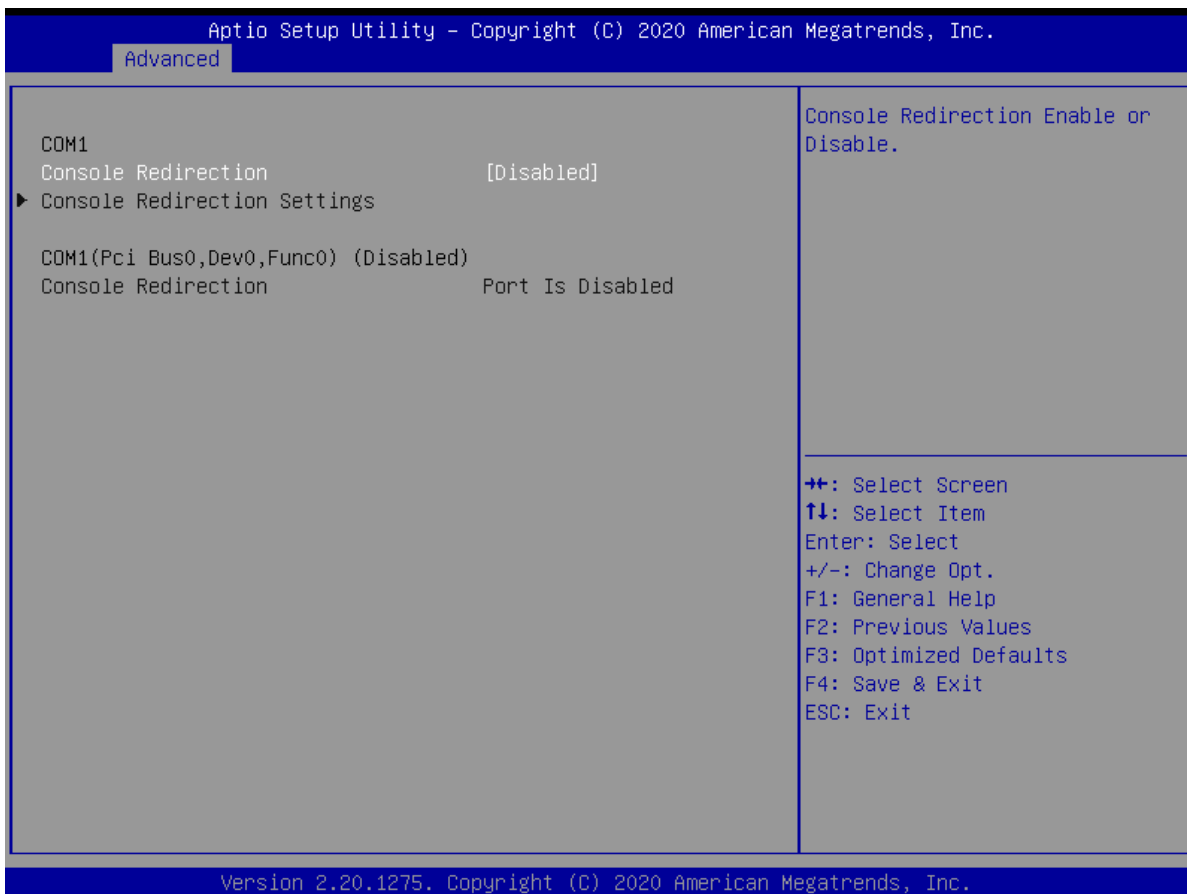

2.11.10 Intel TXT Information

Aptio Setup Utility - Copyright (C) 2020 American Megatrends, Inc.

Advanced

Intel TXT Information	
Chipset	Production Fused
BiosAcm	Production Fused
Cpu Txt	Not Supported
Error Code	None
Class Code	None
Major Code	None
Minor Code	None

++: Select Screen
 ↑↓: Select Item
 Enter: Select
 +/-: Change Opt.
 F1: General Help
 F2: Previous Values
 F3: Optimized Defaults
 F4: Save & Exit
 ESC: Exit

Version 2.20.1275. Copyright (C) 2020 American Megatrends, Inc.

2.11.11 USB Configuration

Aptio Setup Utility - Copyright (C) 2020 American Megatrends, Inc.

Advanced

USB Configuration	
USB Module Version	23
USB Controllers:	
1 XHCI	
USB Devices:	
1 Drive, 2 Keyboards, 1 Mouse, 1 Hub	
Legacy USB Support	[Enabled]
XHCI Hand-off	[Enabled]
USB Mass Storage Driver Support	[Enabled]
USB hardware delays and time-outs:	
USB transfer time-out	[20 sec]
Device reset time-out	[20 sec]
Device power-up delay	[Auto]
Mass Storage Devices:	
TOSHIBA	[Auto]

Enables Legacy USB support. AUTO option disables legacy support if no USB devices are connected. DISABLE option will keep USB devices available only for EFI applications.

++: Select Screen
 ↑↓: Select Item
 Enter: Select
 +/-: Change Opt.
 F1: General Help
 F2: Previous Values
 F3: Optimized Defaults
 F4: Save & Exit
 ESC: Exit

Version 2.20.1275. Copyright (C) 2020 American Megatrends, Inc.

2.11.12 CSM Configuration

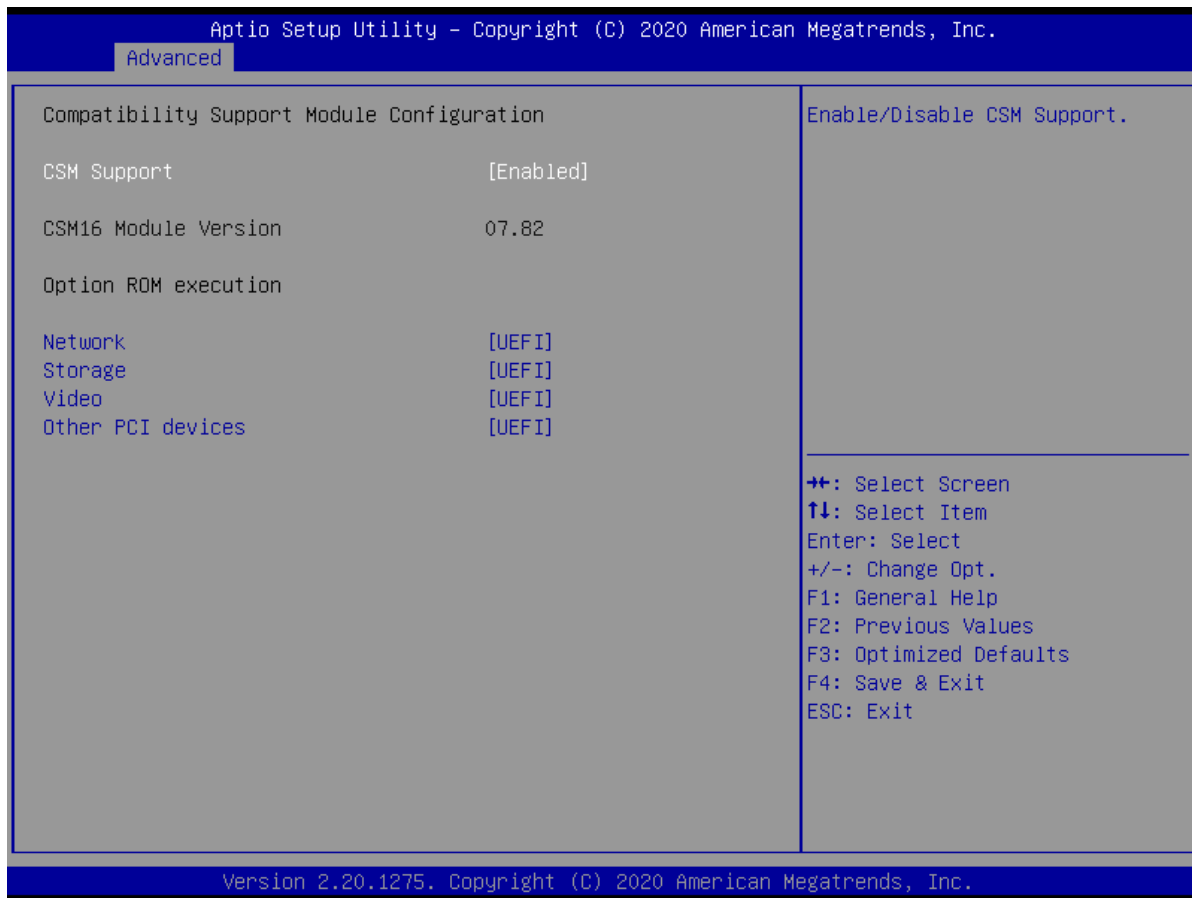

2.11.13 NVME Configuration



2.11.14 Network Stack Configuration

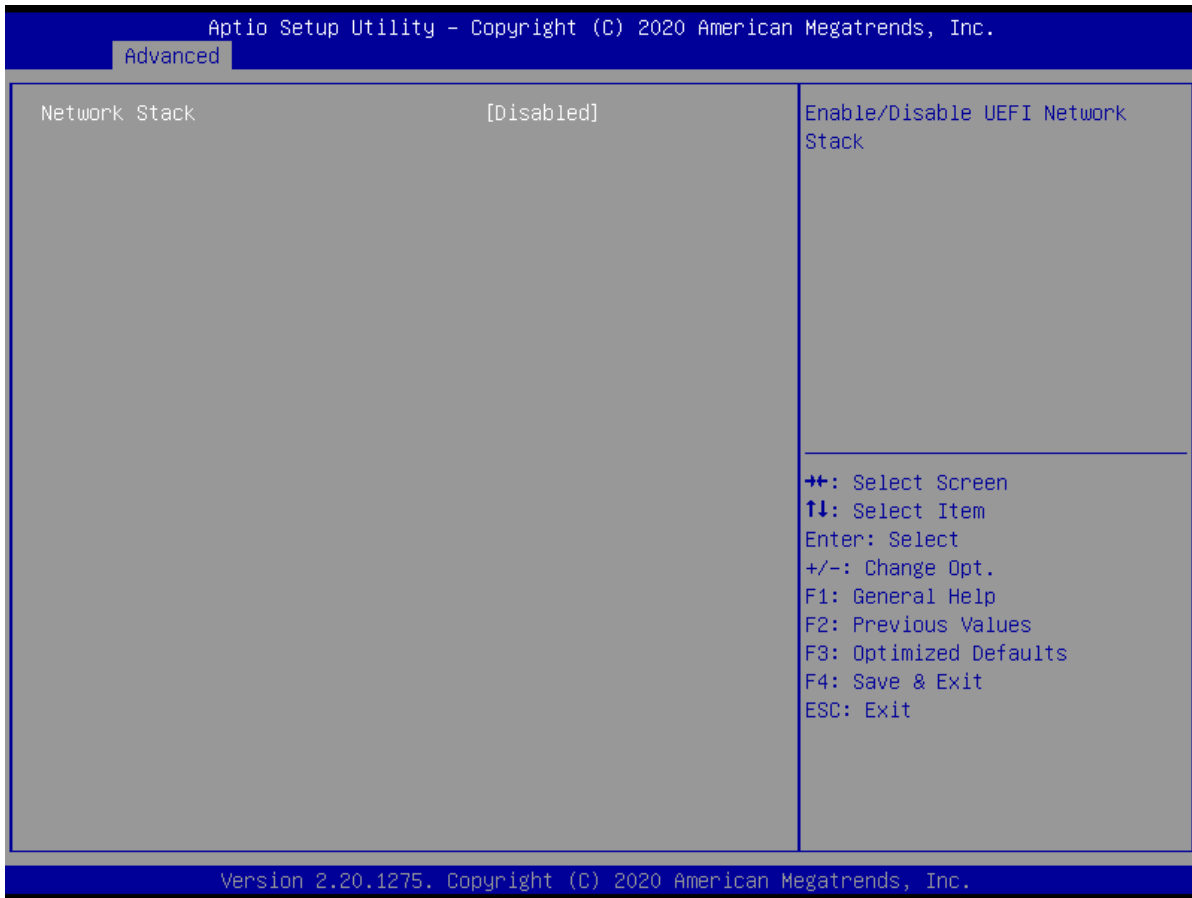

2.12 Chipset

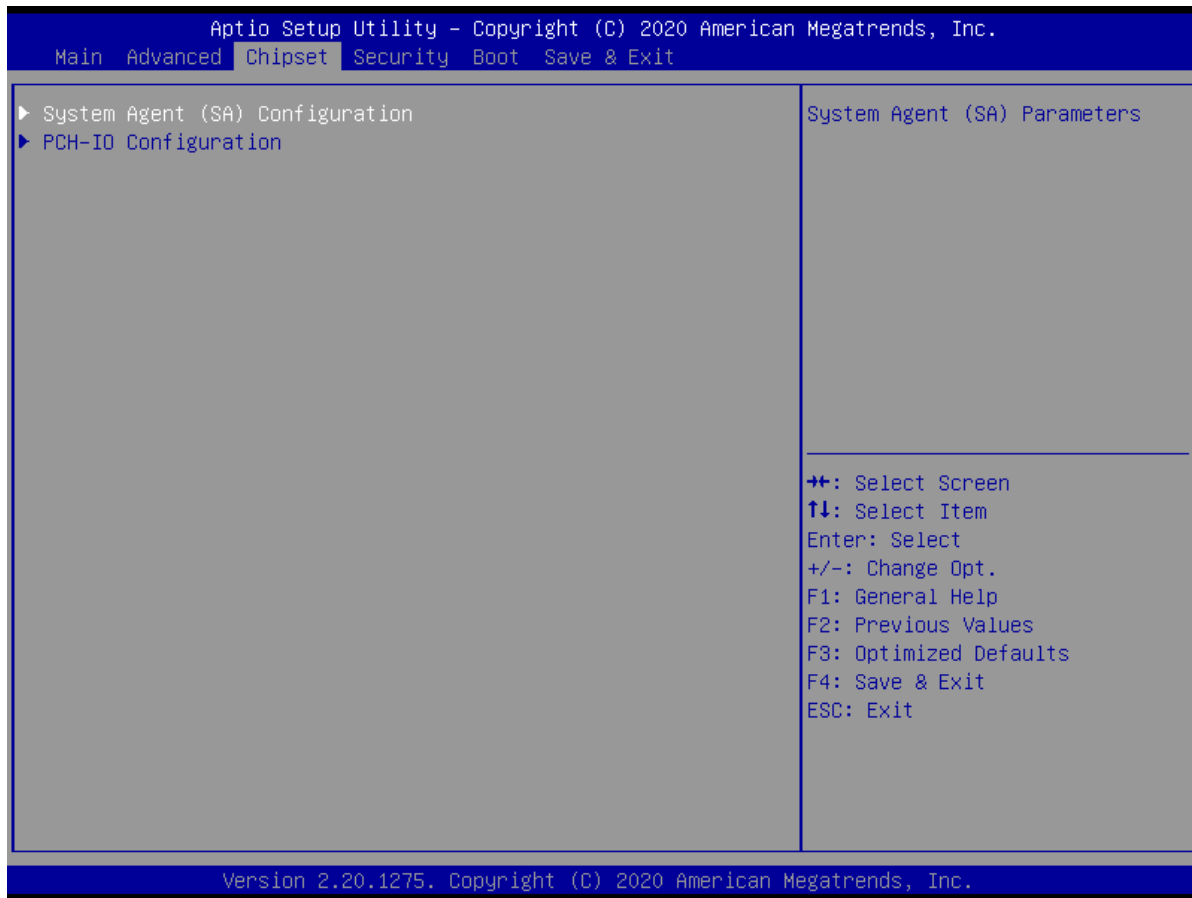

2.12.1 System Agent (SA) Configuration

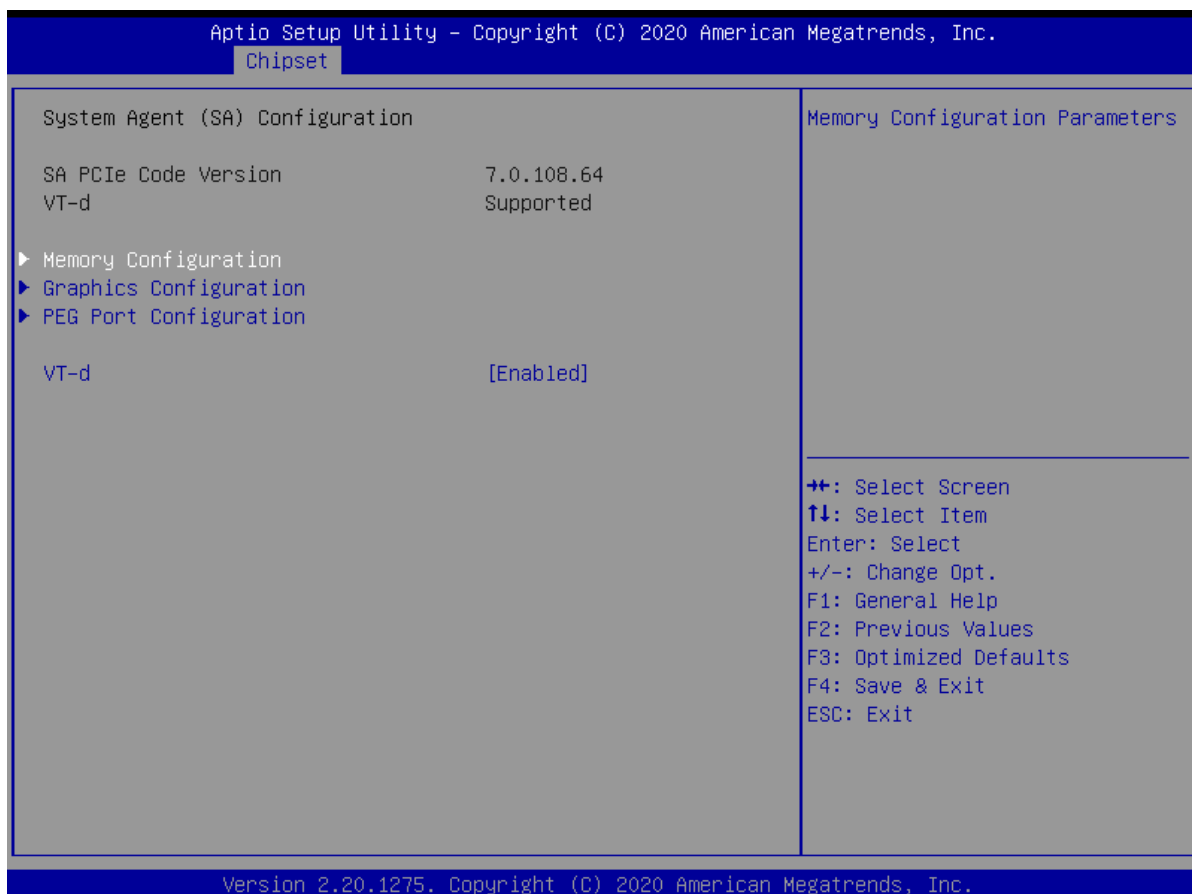

Aptio Setup Utility - Copyright (C) 2020 American Megatrends, Inc.

Chipset

<p>Memory Configuration</p> <p>Memory RC Version 0.7.1.111</p> <p>Memory Frequency 2400 MHz</p> <p>Memory Timings (tCL-tRCD-tRP-tRAS) 16-16-16-39</p> <p>DIMM_A1 Populated & Enabled</p> <p> Size 4096 MB (DDR4)</p> <p> Number of Ranks 1</p> <p> Manufacturer Crucial Technology</p> <p>DIMM_A2 Not Populated / Disabled</p> <p>DIMM_B1 Not Populated / Disabled</p> <p>DIMM_B2 Not Populated / Disabled</p> <p>Max TOLUD [Dynamic]</p>	<p>Maximum Value of TOLUD. Dynamic assignment would adjust TOLUD automatically based on largest MMIO length of installed graphic controller</p> <hr/> <p>++: Select Screen ↑↓: Select Item Enter: Select +/-: Change Opt. F1: General Help F2: Previous Values F3: Optimized Defaults F4: Save & Exit ESC: Exit</p>
---	---

Version 2.20.1275. Copyright (C) 2020 American Megatrends, Inc.

Aptio Setup Utility - Copyright (C) 2020 American Megatrends, Inc.

Chipset

<p>Graphics Configuration</p> <p>Primary Display [Auto]</p> <p>Internal Graphics [Auto]</p> <p>DVMT Pre-Allocated [32M]</p> <p>DVMT Total Gfx Mem [256M]</p>	<p>Select which of IGFX/PEG/PCI Graphics device should be Primary Display Or select SG for Switchable Gfx.</p> <hr/> <p>++: Select Screen ↑↓: Select Item Enter: Select +/-: Change Opt. F1: General Help F2: Previous Values F3: Optimized Defaults F4: Save & Exit ESC: Exit</p>
--	--

Version 2.20.1275. Copyright (C) 2020 American Megatrends, Inc.

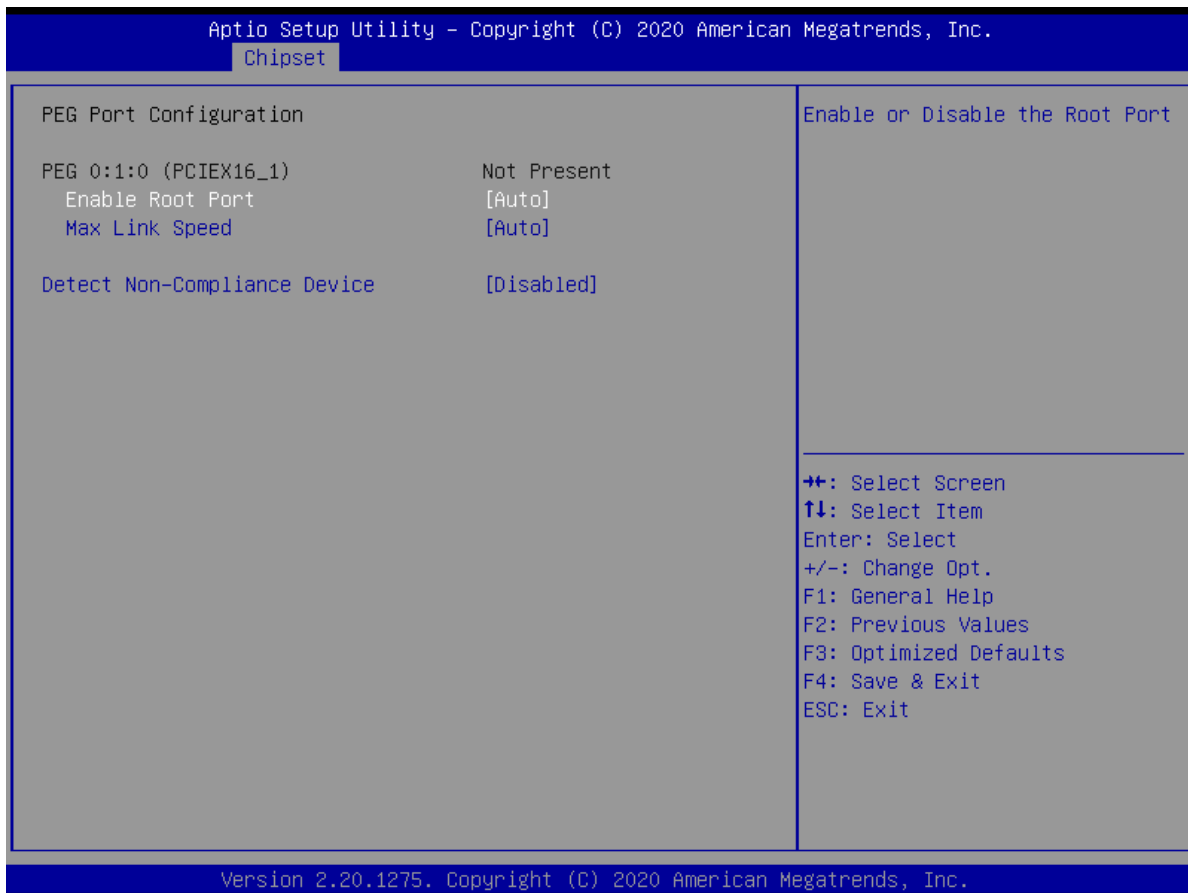

2.12.2 PCH-IO Configuration



Aptio Setup Utility - Copyright (C) 2020 American Megatrends, Inc.

Chipset

<p>PCI Express Configuration</p> <p>DMI Link ASPM Control [Auto]</p> <ul style="list-style-type: none"> ▶ PCI Express Root Port 1 ▶ PCI Express Root Port 5 ▶ PCI Express Root Port 14 ▶ PCI Express Root Port 19 ▶ PCI Express Root Port 21 	<p>The control of Active State Power Management of the DMI Link.</p> <hr/> <p> ++: Select Screen ↑↓: Select Item Enter: Select +/-: Change Opt. F1: General Help F2: Previous Values F3: Optimized Defaults F4: Save & Exit ESC: Exit </p>
---	--

Version 2.20.1275. Copyright (C) 2020 American Megatrends, Inc.

Aptio Setup Utility - Copyright (C) 2020 American Megatrends, Inc.

Chipset

<p>PCI Express Root Port 1 (PCIEX4_1) [Enabled]</p> <p>ASPM [Disabled]</p> <p>L1 Substates [Disabled]</p> <p>PCIe Speed [Auto]</p> <p>▶ Extra options</p>	<p>Control the PCI Express Root Port.</p> <hr/> <p> ++: Select Screen ↑↓: Select Item Enter: Select +/-: Change Opt. F1: General Help F2: Previous Values F3: Optimized Defaults F4: Save & Exit ESC: Exit </p>
---	---

Version 2.20.1275. Copyright (C) 2020 American Megatrends, Inc.

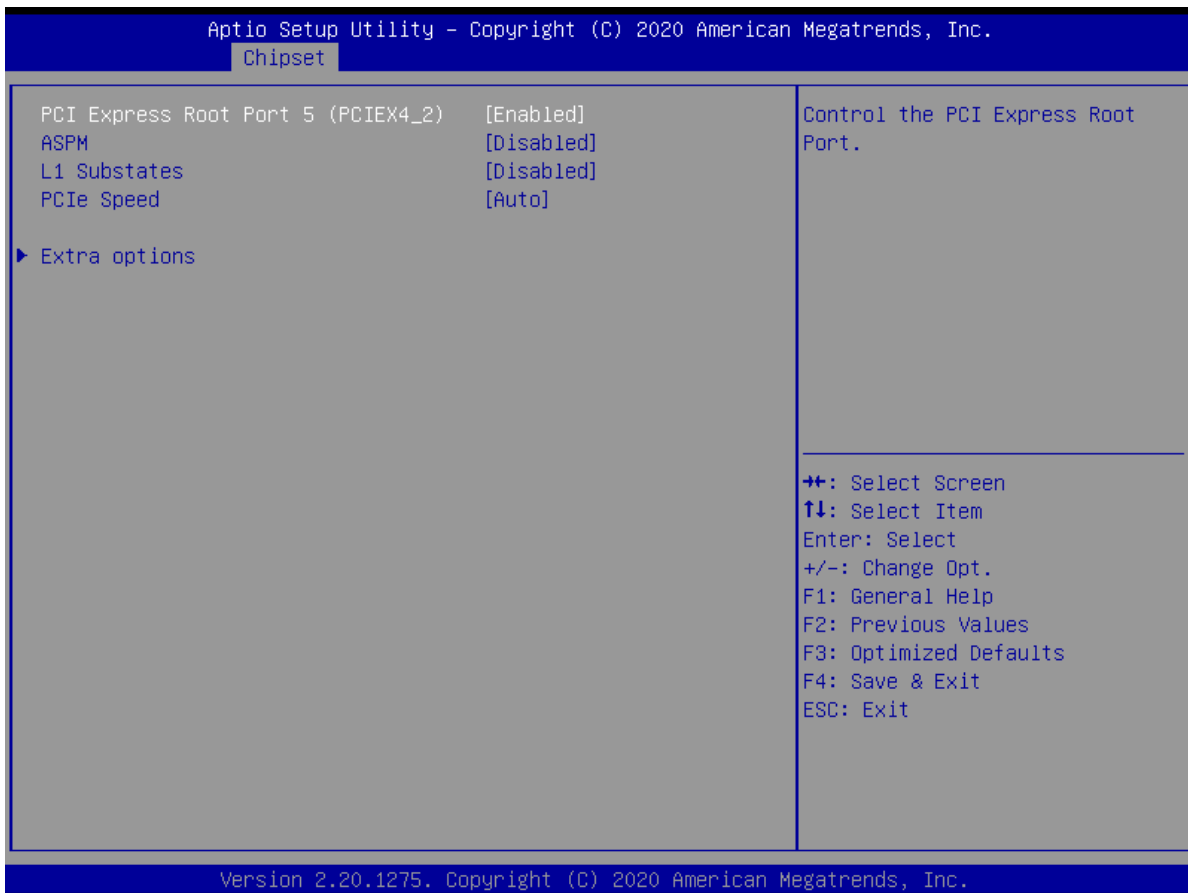
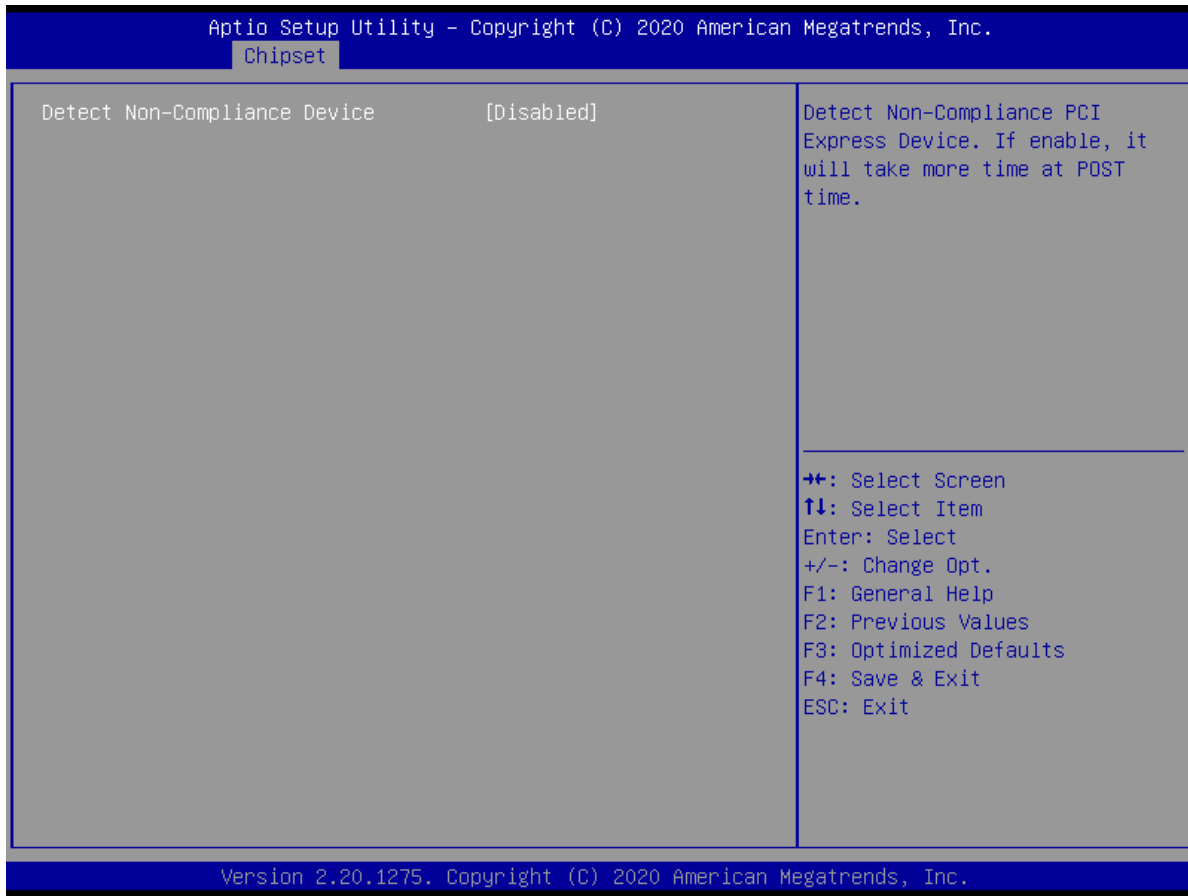

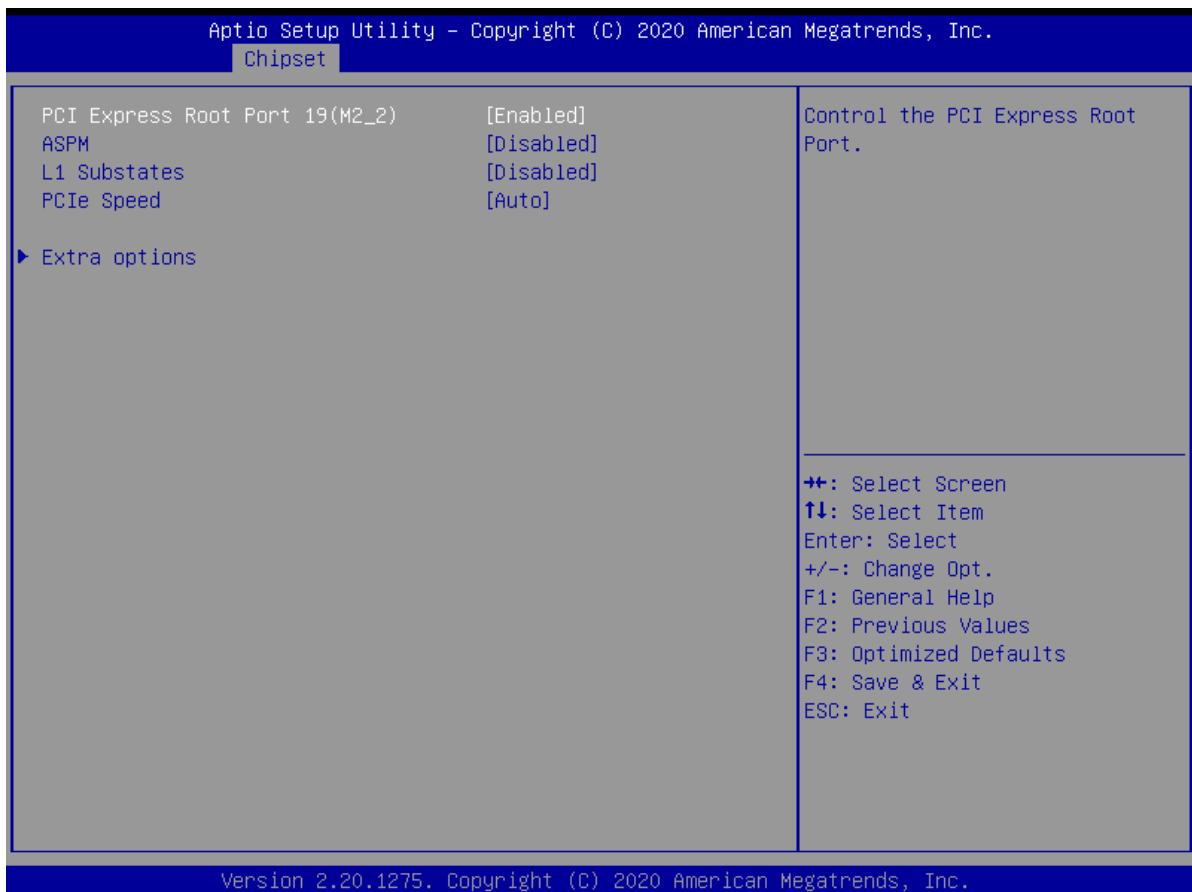
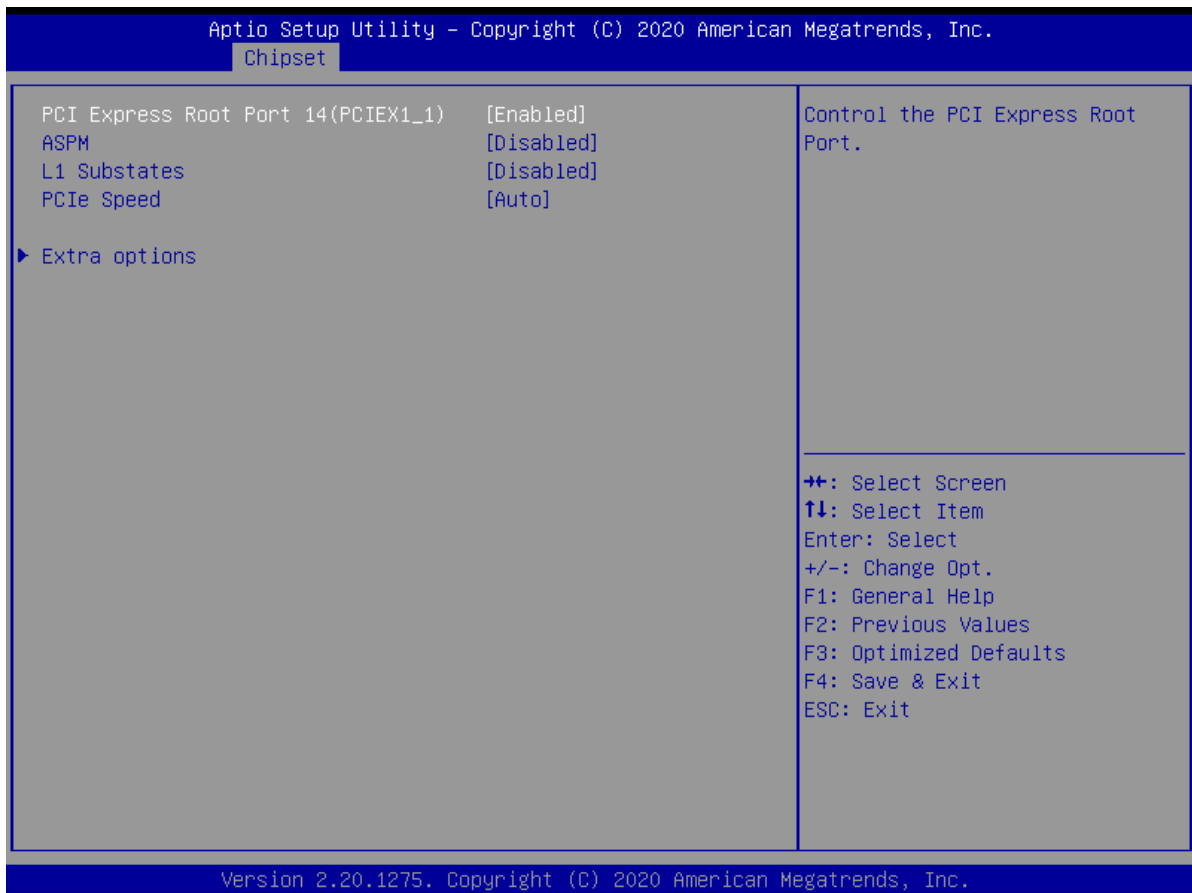

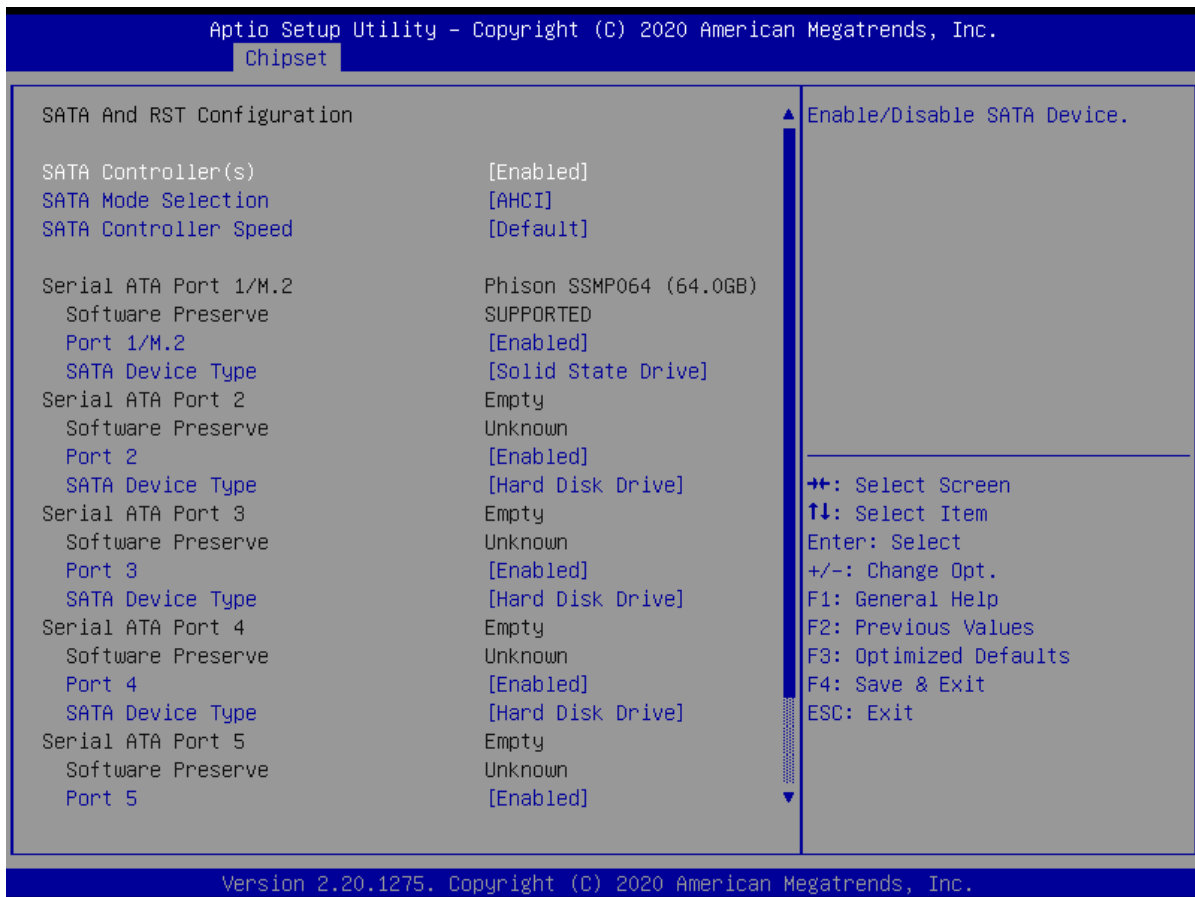
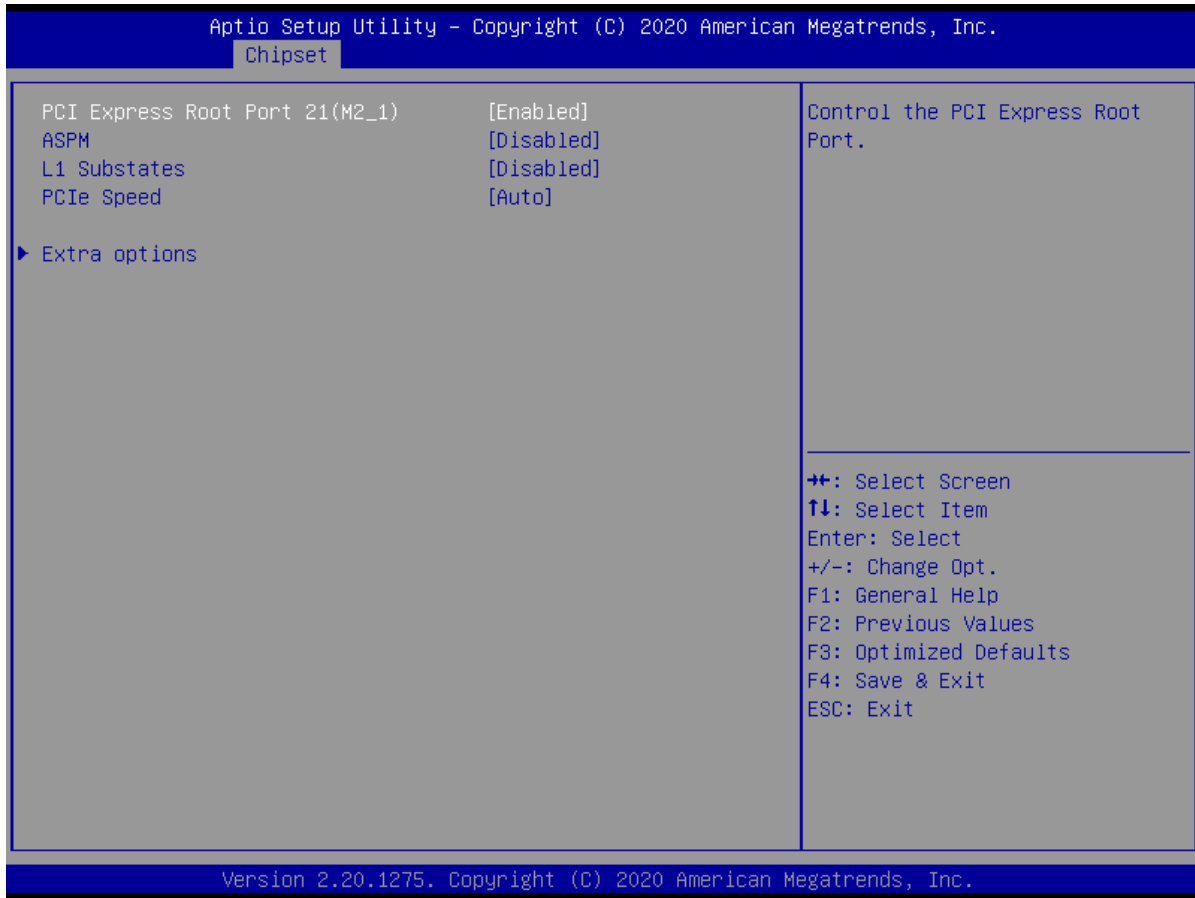

Aptio Setup Utility - Copyright (C) 2020 American Megatrends, Inc.

Chipset

<p>USB Configuration</p> <p>XHCI Compliance Mode [Disabled]</p> <p>USB1/2 Standby Power [Enabled]</p> <p>USB3/4 Standby Power [Enabled]</p> <p>USB5/6 Standby Power [Enabled]</p> <p>USB7/8 Standby Power [Enabled]</p> <p>USB9/10 Standby Power [Enabled]</p> <p>USB11/12 Standby Power [Enabled]</p> <p>USB13/14 Standby Power [Enabled]</p> <p>USB Port Disable Override [Disabled]</p>	<p>Option to enable Compliance Mode. Default is to disable Compliance Mode. Change to enabled for Compliance Mode testing.</p> <hr/> <p>→+: Select Screen ↑↓: Select Item Enter: Select +/-: Change Opt. F1: General Help F2: Previous Values F3: Optimized Defaults F4: Save & Exit ESC: Exit</p>
--	--

Version 2.20.1275. Copyright (C) 2020 American Megatrends, Inc.

Aptio Setup Utility - Copyright (C) 2020 American Megatrends, Inc.

Chipset

<p>HD Audio Subsystem Configuration Settings</p> <p>HD Audio [Enabled]</p> <p>Amplifier GAIN(db) [15.3db]</p>	<p>Control Detection of the HD-Audio device. Disabled = HDA will be unconditionally disabled Enabled = HDA will be unconditionally enabled.</p> <hr/> <p>→+: Select Screen ↑↓: Select Item Enter: Select +/-: Change Opt. F1: General Help F2: Previous Values F3: Optimized Defaults F4: Save & Exit ESC: Exit</p>
---	---

Version 2.20.1275. Copyright (C) 2020 American Megatrends, Inc.

2.13 Security

Aptio Setup Utility - Copyright (C) 2020 American Megatrends, Inc.

Main Advanced Chipset **Security** Boot Save & Exit

<p>Password Description</p> <p>If ONLY the Administrator's password is set, then this only limits access to Setup and is only asked for when entering Setup.</p> <p>If ONLY the User's password is set, then this is a power on password and must be entered to boot or enter Setup. In Setup the User will have Administrator rights.</p> <p>The password length must be in the following range:</p> <p>Minimum length 3</p> <p>Maximum length 20</p> <p>Administrator Password</p> <p>User Password</p> <p>HDD Security Configuration:</p> <p>P1:Phison SSMP064GTB3C0-S11</p> <p>▶ Secure Boot</p>	<p>Set Administrator Password</p> <hr/> <p>⇧⇧: Select Screen</p> <p>⇧↓: Select Item</p> <p>Enter: Select</p> <p>+/-: Change Opt.</p> <p>F1: General Help</p> <p>F2: Previous Values</p> <p>F3: Optimized Defaults</p> <p>F4: Save & Exit</p> <p>ESC: Exit</p>
--	---

Version 2.20.1275. Copyright (C) 2020 American Megatrends, Inc.

2.13.1 Secure Boot

Aptio Setup Utility - Copyright (C) 2020 American Megatrends, Inc.

Security

System Mode	Setup	Secure Boot feature is Active if Secure Boot is Enabled, Platform Key(PK) is enrolled and the System is in User mode. The mode change requires platform reset
Secure Boot	[Disabled] Not Active	
Secure Boot Mode	[Custom]	<p>⇧⇧: Select Screen</p> <p>⇧↓: Select Item</p> <p>Enter: Select</p> <p>+/-: Change Opt.</p> <p>F1: General Help</p> <p>F2: Previous Values</p> <p>F3: Optimized Defaults</p> <p>F4: Save & Exit</p> <p>ESC: Exit</p>
▶ Restore Factory Keys		
▶ Reset To Setup Mode		
▶ Key Management		

Version 2.20.1275. Copyright (C) 2020 American Megatrends, Inc.

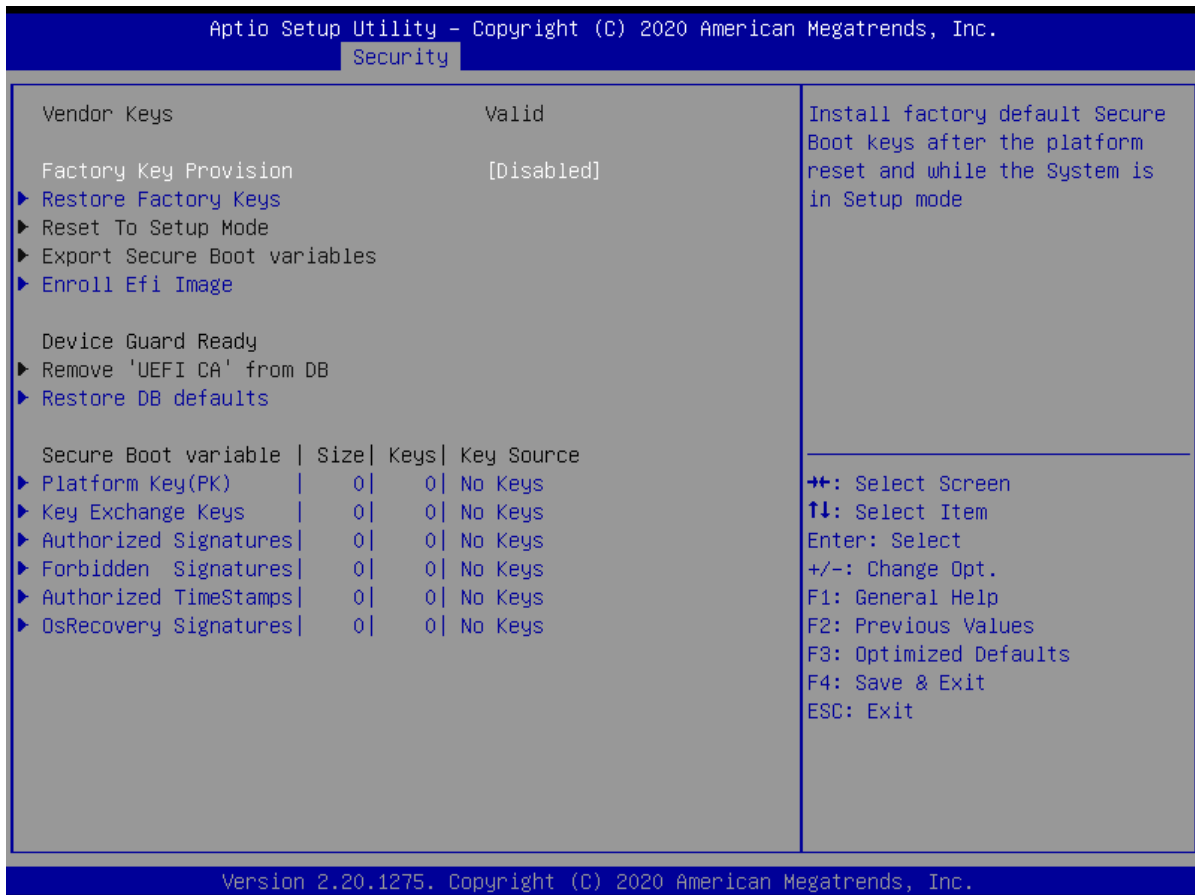

2.14 Boot

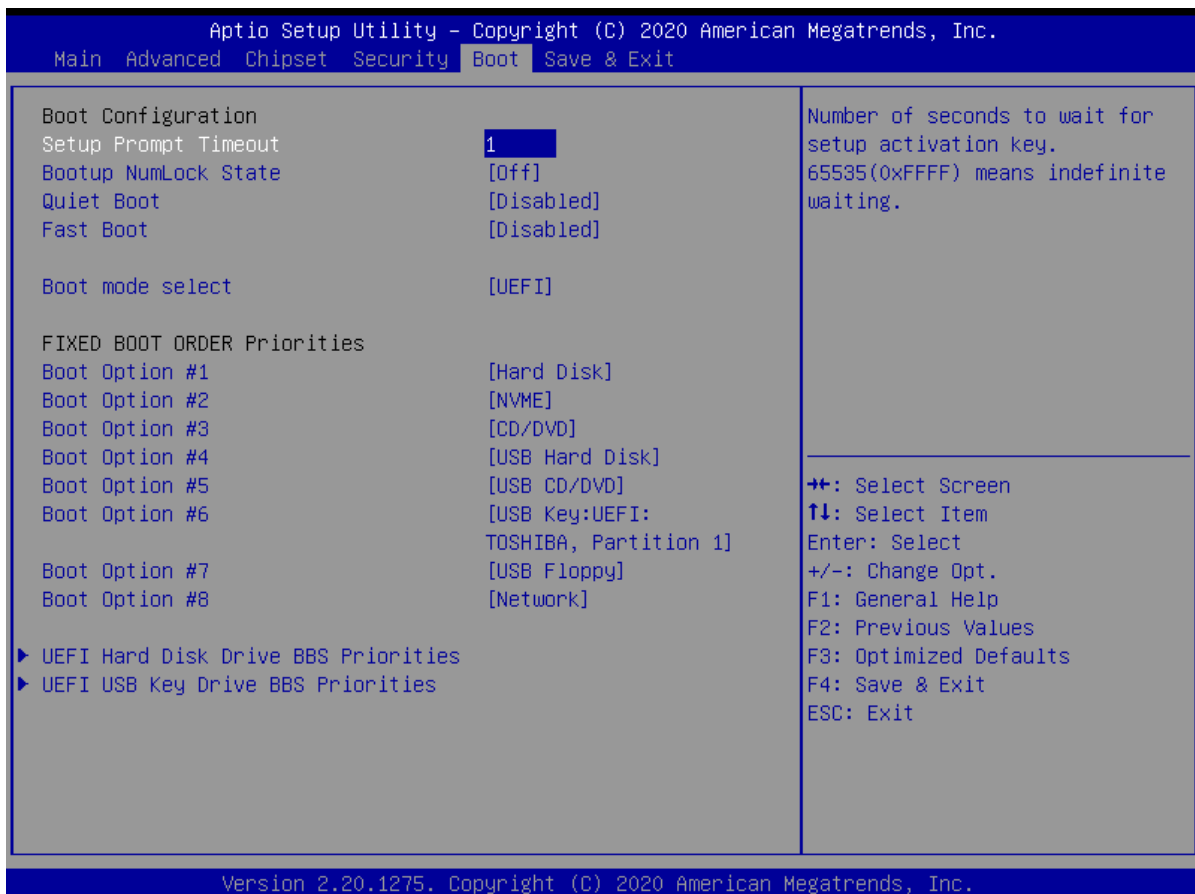

2.15 Save & Exit

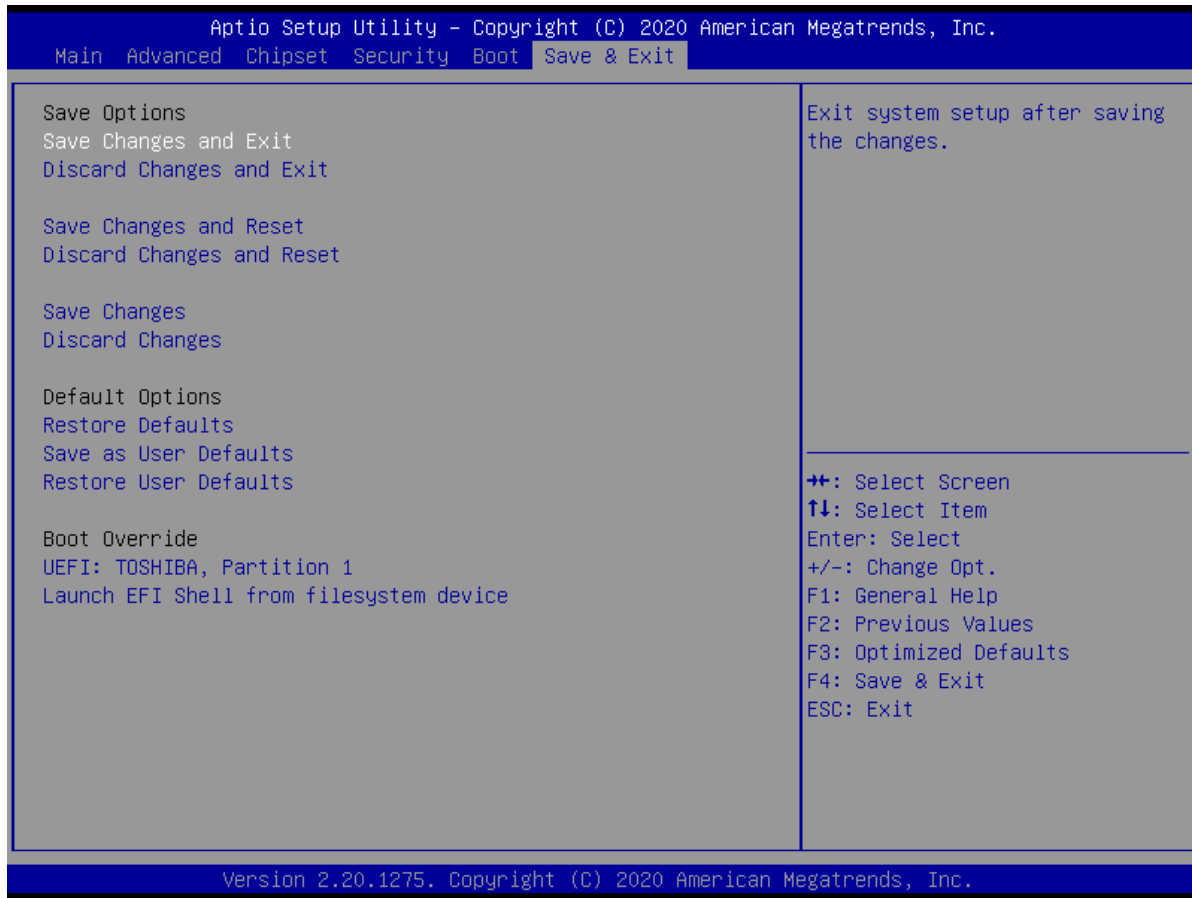

Appendix

GPIO & WDT

This appendix provides the sample codes of WDT (Watch Dog Timer) and GPIO (General Purpose Input/ Output).

General Purpose Input Output

GPI and GPO pins may be implemented as GPIO.

Signal	I/O	Description
GPO[0:3]	O	General purpose output pins. Upon a hardware reset, these outputs should be low.
GPI[0:3]	I	General purpose input pins. Pulled high internally on the Module.

GPIO Configuration

Board Design

Pin#	GPIO#	Default Configuration
1		+5V_DUAL
2		GND
3	GP34	GPO0
4	GP30	GPI0
5	GP35	GPO1
6	GP31	GPI1
7	GP36	GPO2
8	GP32	GPI2
9	GP37	GPO3
10	GP33	GPI3

Notes

1. Output pin default setting is “HIGH”

The GPIO function is provided by a Nuvoton NCT6106D, and it can be accessed through its GPIO index/data port. The index port is the base address +0 and the data port is the base address +1. To access the GPIO register, write index to the index port, and then read/write from/to data port. The configuration is described as below.

Super I/O entry key: 0x87

Index Port	0x2E
Data Port	0x2F

Registers Description

GPIO Input / Output Select:

Location: Address ECh
 Attribute: Read/Write
 Reset by: GP3X_MRST
 Default: FFh
 Size: 8 bits

BIT	READ/WRIT	Description
7-0	R/W	GPIO3 I/O register 0: The respective GPIO3 PIN is programmed as an output port 1: The respective GPIO3 PIN is programmed as an input port.

GPIO Output Data Select:

Location: Address EDh
 Attribute: Read/Write
 Reset by: GP3X_MRST
 Default: 00h
 Size: 8 bits

BIT	READ/WRIT	Description
7-0	R/W	GPIO3 Data register For output ports, the respective bits can be read/written and produced to pins.
	Read Only	For input ports, the respective bits can be read only from pins. Write accesses will be ignored.

Note.

Bit X = 0 outputs low when in output mode
 Bit X = 1 outputs high when in output mode

Watchdog Timer

Board Design

The Watchdog Timer (WDT) is implemented by Nuvoton NCT6106D.

Pseudo Code

```
#include<dos.h>
#include<stdio.h>
void main(void){
    // for 2E
    int x,pre_rd,rd,status;
    clrscr();
    outputb(0x2E,0x87);
    outputb(0x2E,0x87);
    outputb(0x2E,0x30); //CR30 bit1=1 pin77 select WDTO#
    outputb(0x2F,0x01);
    outputb(0x2E,0x07);
    outputb(0x2F,0x08); //Logic Device8 (LD8)
    outputb(0x2E,0x30);
    outputb(0x2F,0x01); //Enable WDTO#

    // Reset WDTO# and clear WDTO# timeout event
    outputb(0x2E,0xF6);
    outputb(0x2F,0x00); //Reset WDTO# Timer
    outputb(0x2E,0xF7); //Logic Device 8, CRF7
    outputb(0x2F,0x00); //Write Bit4=0 to clear WDTO# event!

    // Input Timer value
    printf("Enter WDTO# Timer(second):");
    scanf("%d",&x);
    pre_rd = x + 1;
    // Set Timer and Start count
    outputb(0x2E,0xF6); //LD8,CRF6h Set WDTO# Timer
    outputb(0x2F,x);

    // Check the timeout event
    // LDN8 CRF7[4] = 1 (Timeout occur)
    do{
        // Read Count
        outputb(0x2E,0xF6); //LD8,CRF6h Set WDTO# Timer
        rd = inportb(0x2F);
        // Read Timeout event
        outputb(0x2E,0xF7); //Logic Device 8, CRF7
        status = inportb(0x2F);
        // check pre-status
        if (rd < pre_rd){
            printf("Timer = %d\n",rd);
            pre_rd = rd;
        }
    }while(status != 0x10);
    printf("Timer Timeout.\n");

    printf("Input any key to reset timeout event\n");
    getch();

    // Reset WDTO# and clear WDTO# timeout event
    outputb(0x2E,0xF6);
    outputb(0x2F,0x00); //Reset WDTO# Timer
    outputb(0x2E,0xF7); //Logic Device 8, CRF7
    outputb(0x2F,0x00); //Write Bit4=0 to clear WDTO# event!
```

