

# USER'S MANUAL

## PC100 Series PC Module



# Table of Contents

<b>Prefaces</b> .....	<b>04</b>
Revision .....	04
Disclaimer .....	04
Copyright Notice .....	04
Trademarks Acknowledgment .....	04
Environmental Protection Announcement .....	04
Safety Precautions .....	05
Technical Support and Assistance .....	06
Conventions Used in this Manual .....	06
Package Contents .....	07
Ordering Information .....	07
Optional Accessory .....	07
<b>Chapter 1 Product Introductions</b> .....	<b>08</b>
1.1 Overview .....	09
1.1.1 Key Feature .....	09
1.2 Hardware Specification .....	10
1.3 System I/O .....	11
1.3.1 PC100 .....	11
1.3.2 PC110 .....	14
1.4 Mechanical Dimensions .....	17
1.4.1 PC100 .....	17
1.4.2 PC110 .....	18
<b>Chapter 2 Switches and Connectors</b> .....	<b>19</b>
2.1 Switch and connector Locations .....	20
2.1.1 Top View .....	20
2.1.2 Bottom View .....	20
2.2 Connector / Switch Definition .....	21
2.3 Switch Definitions .....	22
2.4 Connector Definitions .....	24
<b>Chapter 3 System Setup</b> .....	<b>35</b>
3.1 Set torque force to 3.5 kgf-cm to execute all the screwing and unscrewing .....	36
3.2 Installing SODIMM .....	36
3.3 Installing mini PCIe card / mSATA .....	37
3.4 Installing HDD on removable SATA HDD bay .....	38
3.5 Installing CFast card .....	40
3.6 Installing SIM card .....	41
3.7 Removing chassis bottom cover .....	43
3.8 Installing antenna .....	44
3.9 Assemble chassis top cover .....	47
3.10 Connecting PC module with VIO display module .....	49

<b>Chapter 4</b>	<b>BIOS Setup .....</b>	<b>51</b>
4.1	BIOS Introduction .....	52
4.2	Main Setup .....	53
	4.2.1 System Date .....	53
	4.2.2 System Time .....	53
4.3	Advanced Setup .....	54
	4.3.1 Trusted Computing (Optional) .....	54
	4.3.2 ACPI Settings .....	55
	4.3.3 Super IO Configuration .....	55
	4.3.4 Hardware Monitor .....	59
	4.3.5 Serial Port Console Redirection .....	60
	4.3.6 CPU Configuration .....	60
	4.3.7 SATA Configuration .....	61
	4.3.8 OS Configuration .....	61
	4.3.9 CSM Configuration .....	62
	4.3.10 USB Configuration .....	63
	4.3.11 Intel® I210 Gigabit Network Connection- XX:XX:XX:XX:XX:XX .....	64
4.4	Chipset .....	65
	4.4.1 North Bridge .....	65
	4.4.2 South Bridge .....	67
4.5	Security .....	69
	4.5.1 Administrators Password .....	69
	4.5.2 Users Password .....	69
4.6	Boot .....	70
	4.6.1 Setup Prompt Timeout .....	70
	4.6.2 Bootup NumLock State .....	70
	4.6.3 Full Screen Logo Show .....	70
	4.6.4 Boot Option Priorities .....	70
4.7	Save & Exit .....	71
	4.7.1 Save Changes and Reset .....	71
	4.7.2 Discard Changes and Reset .....	71
	4.7.3 Restore Defaults .....	71
<b>Appendix</b>	<b>WDT &amp; GPIO .....</b>	<b>72</b>
	WDT Sample Code .....	73
	GPIO Sample Code .....	74

## Prefaces

### Revision

Revision	Description	Date
1.0	Manual Released	2018/11/28

### Disclaimer

All specifications and information in this User's Manual are believed to be accurate and up to date. C&T Solution Inc. does not guarantee that the contents herein are complete, true, accurate or non-misleading. The information in this document is subject to change without notice and does not represent a commitment on the part of C&T Solution Inc.

C&T Solution Inc. disclaims all warranties, express or implied, including, without limitation, those of merchantability, fitness for a particular purpose with respect to contents of this User's Manual. Users must take full responsibility for the application of the product.

### Copyright Notice

All rights reserved. No part of this manual may be reproduced or transmitted in any form or by any means, electronic or mechanical, including photocopying, recording, or information storage and retrieval systems, without the prior written permission of C&T Solution Inc. Copyright © C&T Solution Inc.

### Trademarks Acknowledgment

Intel®, Celeron® and Pentium® are trademarks of Intel Corporation.

Windows® is registered trademark of Microsoft Corporation.

AMI is trademark of American Megatrend Inc.

IBM, XT, AT, PS/2 and Personal System/2 are trademarks of International Business Machines Corporation

All other products and trademarks mentioned in this manual are trademarks of their respective owners.

### Environmental Protection Announcement

Do not dispose this electronic device into the trash while discarding. Please recycle to minimize pollution and ensure environment protection.



## Safety Precautions

Before installing and using the equipment, please read the following precautions:

- Put this equipment on a reliable surface during installation. Dropping it or letting it fall could cause damage.
- The power outlet shall be installed near the equipment and shall be easily accessible.
- Turn off the system power and disconnect the power cord from its source before making any installation. Be sure both the system and the external devices are turned OFF. Sudden surge
- of power could ruin sensitive components. Make sure the equipment is properly grounded.
- When the power is connected, never open the equipment. The equipment should be opened only by qualified service personnel.
- Make sure the voltage of the power source is correct before connecting the equipment to the power outlet.
- Disconnect this equipment from the power before cleaning. Use a damp cloth. Do not use liquid or spray detergents for cleaning.
- Avoid the dusty, humidity and temperature extremes.
- Do not place heavy objects on the equipment.
- If the equipment is not used for long time, disconnect it from the power to avoid being damaged by transient over-voltage.
- The storage temperature shall be above  $-40^{\circ}\text{C}$  and below  $85^{\circ}\text{C}$ .
- The computer is provided with a battery-powered real-time clock circuit. There is a danger of explosion if incorrectly replaced. Replace only with the same or equivalent type recommended by the manufacturer.
- If one of the following situation arises, get the equipment checked by service personnel:
  - The power cord or plug is damaged.
  - Liquid has penetrated into the equipment.
  - The equipment has been exposed to moisture.
  - The equipment does not work well or it cannot work according the user's manual.
  - The equipment has been dropped and damaged.
  - The equipment has obvious signs of breakage.

## Technical Support and Assistance

1. Visit the C&T Solution Inc website at [www.candtsolution.com](http://www.candtsolution.com) where you can find the latest information about the product.
2. Contact your distributor, our technical support team or sales representative for technical support if you need additional assistance. Please have following information ready before you call:
  - Model name and serial number
  - Description of your peripheral attachments
  - Description of your software (operating system, version, application software, etc.)
  - A complete description of the problem
  - The exact wording of any error messages

## Conventions Used in this Manual

**WARNING**

This indication alerts operators to an operation that, if not strictly observed, may result in severe injury.

**CAUTION**

This indication alerts operators to an operation that, if not strictly observed, may result in safety hazards to personnel or damage to equipment.

**NOTE**

This indication provides additional information to complete a task easily.

## Package Contents

Before installation, please ensure all the items listed in the following table are included in the package.

Item	Description	Q'ty
1	PC100 Series PC Module	1
2	Utility DVD Driver	1
3	Screw Pack	1

## Ordering Information

Model No.	Product Description
PC100-J1900	PC Module for Industrial Display System with Intel® Celeron® Processor J1900, 4x COM
PC110-J1900	PC Module for Industrial Display System with Intel® Celeron® Processor J1900, 4x COM, 2x Universal I/O Bracket

## Optional Accessories

Model No.	Product Description
1-E09A06007	Adapter AC/DC 12V 5A 60W with 3pin Terminal Block Plug 5.0mm Pitch
SFICBL022	Power Cord, 3-pin US Type, 180cm
1-TPCD00002	Power Cord, European Type, 180cm
1-TPCD00001	Power Cord, 3-pin UK Type, 180cm

## Chapter 1

# Product Introductions



## 1.1 Overview

The PC100 series PC module is based on Intel® Celeron® J1900 Quad Core Processor. It supports Multi-Mode Display Module (MDM) technology which makes it more flexible in system maintaining and upgrading. It also offers modularize expansion I/O, rich connectivity interfaces, wide range (9~50V) DC power input, and high reliability even operating in temperature extremes (-40 °C~+70 °C).

Featuring with completely cable-less designed and high functional, PC100 series are ruggedized display systems that can operate in harsh environments and easy to install and maintain. A build in over voltage protection (OVP), over current protection (OCP), reverse protection, and wide range DC power input makes PC100 series are safety system for all industrial applications.



### 1.1.1 Key Features

- Intel® Celeron® processor J1900, 2.0 GHz
- 1x 204-pin DDR3L SODIMM. max up to 8GB
- 1x 2.5" SATA HDD bay, 1x mSATA, 1x CFast, 2x SIM socket
- 2x full-size mini PCIe for communication or expansion modules
- 2x LAN, 1x VGA, 1x DisplayPort
- 6x RS-232/422/485 (w/ 2x internal), 1x USB 3.0, 3x USB 2.0, Audio
- 8x DI + 8x DO with isolation
- 2x universal I/O bracket (by mini PCIe interface) (PC110 Only)
- 9 to 50VDC wide range power input
- -40°C to 70°C extended operating temperature

## 1.2 Hardware Specification

### Processor System

- Intel® Celeron® Processor J1900, Quad Core, 2MB Cache, 2.0 GHz

### Memory

- 1x 204-Pin DDR3L 1066/1333MHz SODIMM.
- Max. up to 8GB

### Display

#### Dual Display

- 1x VGA, and 1x DisplayPort

### Expansion

- 2x Full-size Mini PCIe Socket for Wi-Fi / GSM / Expansion Module
- 2x Universal I/O Bracket (PC110 Only)

### Ethernet

- 2x Intel® i210-AT GbE LAN Port, Support Wake-on-LAN and PXE

### Audio

- Codec: Realtek ALC888S
- 1x Mic-in and 1x Line-out

### Watchdog Timer

- Software Programmable Supports 1~255 sec.
- System Reset

### Storage

- 1x External 2.5" SATA HDD Bay
- 1x Internal mSATA Slot (shared by 1x Mini-PCIe)
- 1x CFast (shared by 1x mSATA & 1x Mini PCIe)
- 2x External SIM Card Socket

### I/O Ports

- 1x USB 3.0 Port
- 3x USB 2.0 Port
- 8x Isolated DI and 8x Isolated DO Port
- 4x External DB9 for COM1~4, Support RS232/422/485 with Auto Flow Control
- 2x Internal COM5~6, Support RS232/422/485 with Auto Flow Control
- 3x Antenna Hole
- 1x AT/ATX Switch
- 1x Remote Power on/off Connector

### Digital Input & Output

- 8x Digital Input (Source Type)
  - Input Voltage (Dry Contact):
    - Logic 0: Close to GND
    - Logic 1: Open
  - Input Voltage:
    - Logic 0: 3V max.
    - Logic 1: 5V min. (DI to COM-)
- 8x Digital Output
  - Supply Voltage: 5~30VDC
  - Sink Current: 200 mA Max. Per Channel

### Power

- Support AT, ATX Mode
- 1x 3-pin Terminal Block Connector with Power Input 9~50VDC
- Power Ignition Sensing
- 1x Optional AC/DC 12V/5A, 60W Power Adapter

### Environment

- Operating Temperature: Ambient with Air Flow: -40°C to 70°C (with Industrial Grade Peripherals)
- Storage Temperature: -40°C to 85°C
- Relative humidity: 10%~95% (non-condensing)

### Physical

- **PC100**
  - Dimension (WxDxH, mm): 246 x 220 x 37mm
  - Weight: TBC
- **PC110**
  - Dimension (WxDxH, mm): 252.8 x 225.1 x 59mm
  - Weight: TBC
- Construction: Extruded Aluminum with Heavy Duty Metal
- Mounting: VESA Mounting Holes 75 x 75mm, 100 x 100mm

### Operating System

- Windows® 10
- Windows® 7
- WES7
- Linux kernel 3.X

### Certifications

- CE
- FCC Class A

## 1.3 System I/O

### 1.3.1 PC100

#### Front Panel

##### Removable HDD Bay

Used to insert a 2.5" HDD device

##### CFast Socket

Used to insert CFast card

##### SIM Card Socket

Used to insert SIM card

##### Antenna hole

Used to connect an antenna for optional Mini-PCIe WiFi module

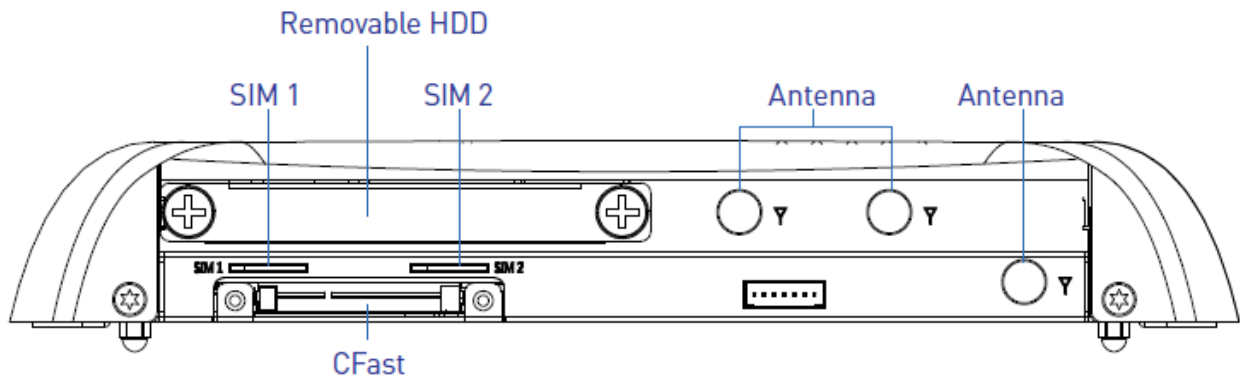

#### Rear Panel

##### DC IN

Used to plug a DC power input with terminal block

##### LAN port

Used to connect the system to a local area network

##### VGA

Used to connect an analog VGA monitor

##### Line-out

Used to connect a speaker

##### DisplayPort

Used to connect a DisplayPort monitor

##### Mic-in

Used to connect a microphone

##### USB 2.0 port

Used to connect USB 2.0/1.1 device

##### Remote power on/off switch

Used to plug a power on/off switch with terminal block

##### USB 3.0 port

Used to connect USB 3.0/2.0/1.1 device

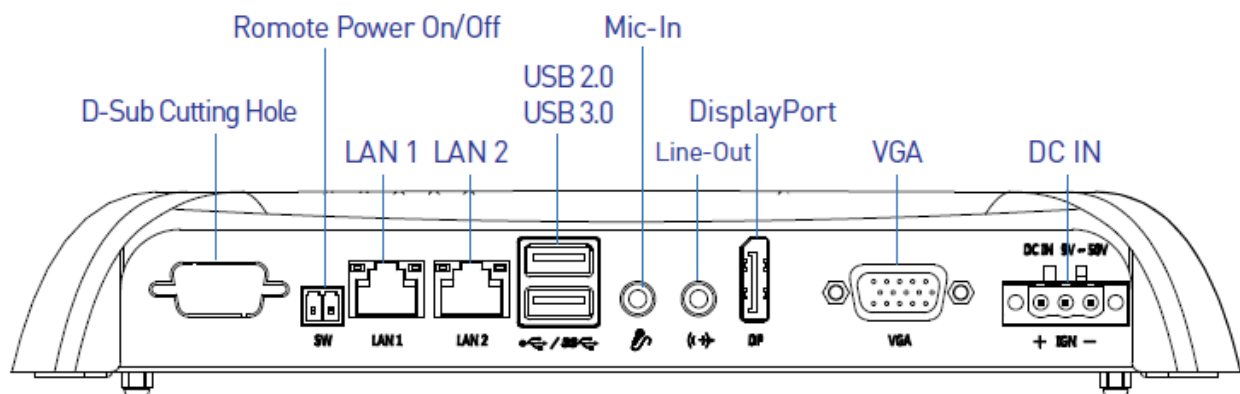

**Side (Right)**

**COM port**

COM3~4 support RS232/422/485 serial device

**DELAY TIME switch**

Used to select Car power turn off delay-time

**PC/CAR mode select switch**

Used to select PC or CAR power mode

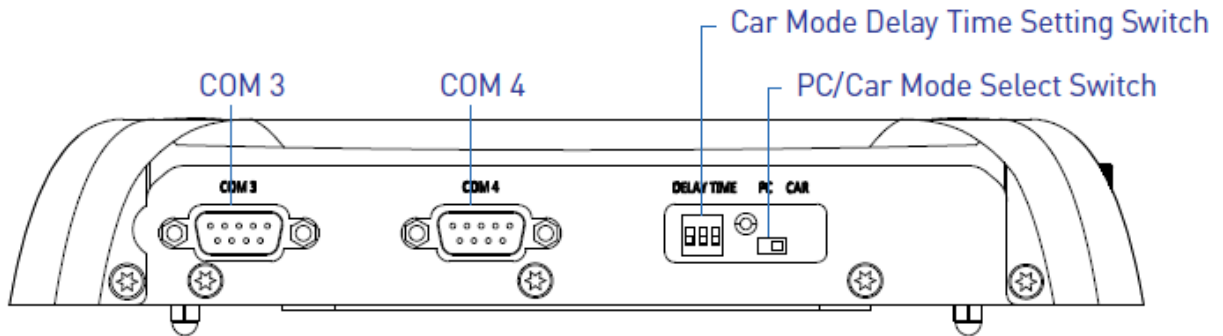

**Side (Left)**

**AT/ATX mode select switch**

Used to select AT or ATX power mode

**ATX power on/off switch**

Press to power-on or power-off the system

**COM port**

COM1~2 support RS232/422/485 serial device

**Power LED**

Indicates the power status of the system

**USB 2.0 port**

Used to connect USB 2.0/1.1 device

**HDD LED**

Indicates the status of the hard drive

**Digital I/O Terminal Block**

The Digital I/O terminal block supports 8 digital input and 8 digital output

**Reset switch**

Press to reset the system

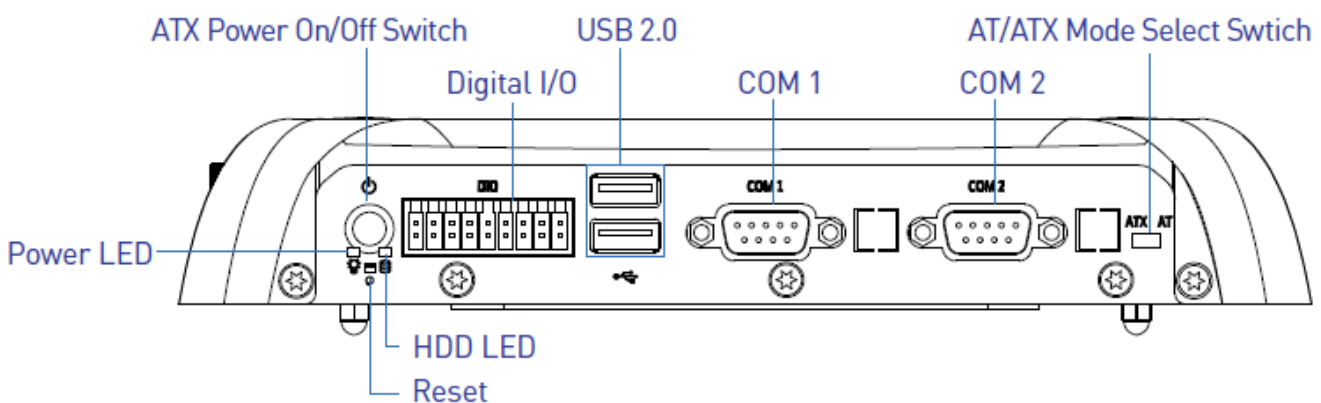

**Top****VESA Mounting Hole**

These are mounting holes for VESA mount (75x75mm and 100x100mm)

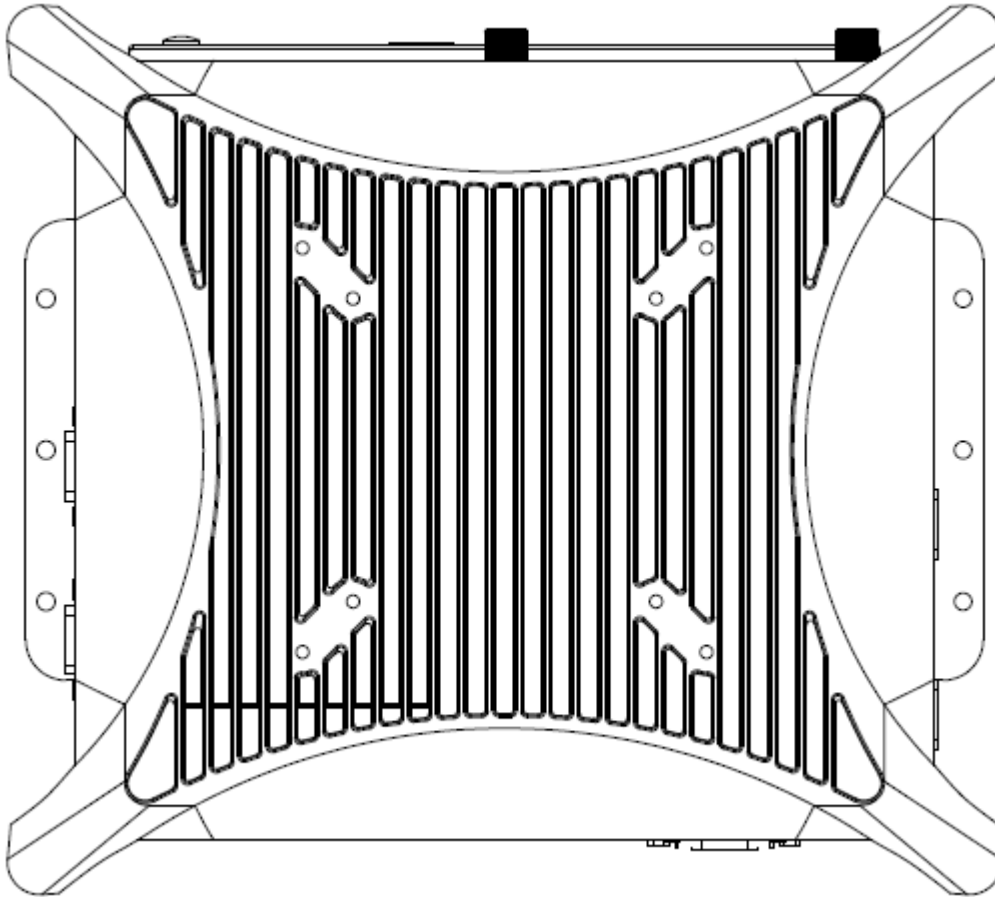

### 1.3.2 PC110

#### Front Panel

##### Removable HDD Bay

Used to insert a 2.5" HDD device

##### CFast Socket

Used to insert CFast card

##### SIM Card Socket

Used to insert SIM card

##### Antenna hole

Used to connect an antenna for optional Mini-PCIe WiFi module

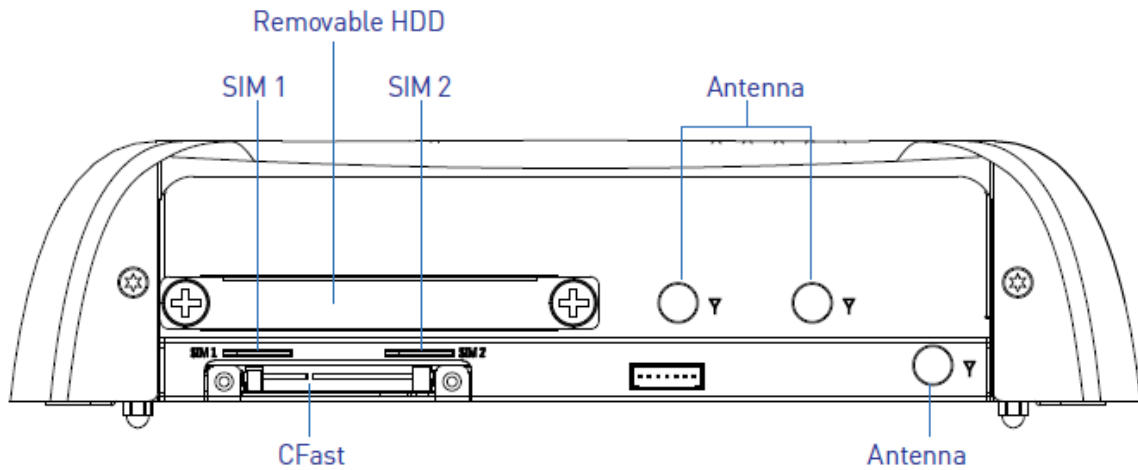

#### Rear Panel

##### DC IN

Used to plug a DC power input with terminal block

##### LAN port

Used to connect the system to a local area network

##### VGA

Used to connect an analog VGA monitor

##### Line-out

Used to connect a speaker

##### DisplayPort

Used to connect a DisplayPort monitor

##### Mic-in

Used to connect a microphone

##### USB 2.0 port

Used to connect USB 2.0/1.1 device

##### Remote power on/off switch

Used to plug a power on/off switch with terminal block

##### USB 3.0 port

Used to connect USB 3.0/2.0/1.1 device

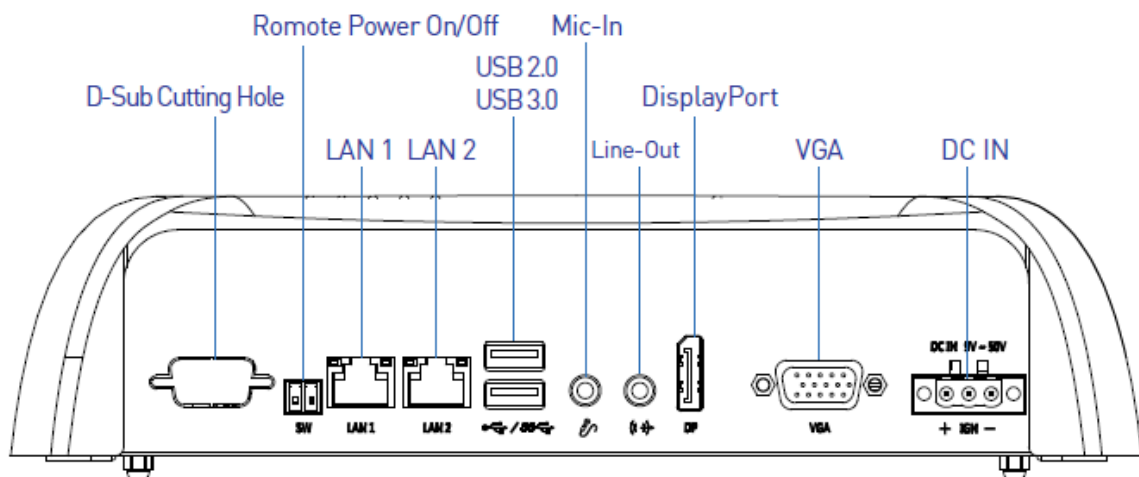

**Side (Right)**

**COM port**

COM3~4 support RS232/422/485 serial device

**DELAY TIME switch**

Used to select Car power turn off delay-time

**PC/CAR mode select switch**

Used to select PC or CAR power mode

**Universal I/O Bracket**

Used to customized I/O output

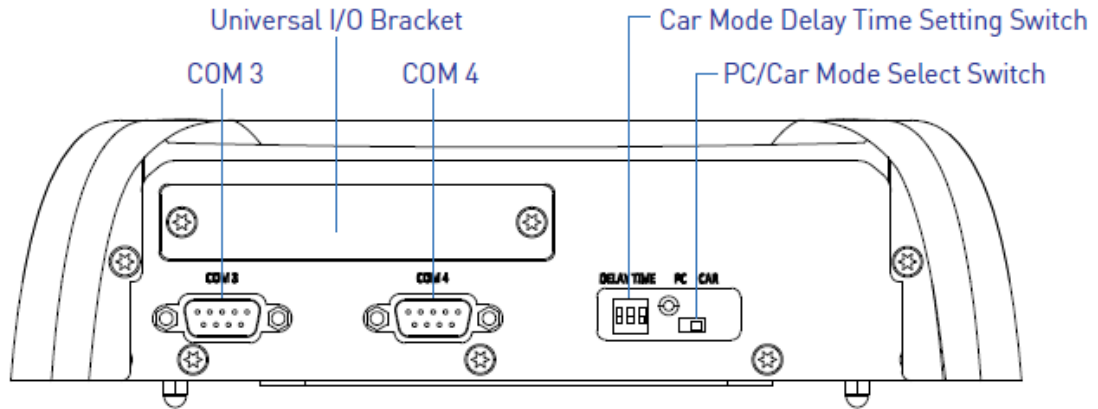

**Side (Left)**

**AT/ATX mode select switch**

Used to select AT or ATX power mode

**ATX power on/off switch**

Press to power-on or power-off the system

**COM port**

COM1~2 support RS232/422/485 serial device

**Power LED**

Indicates the power status of the system

**USB 2.0 port**

Used to connect USB 2.0/1.1 device

**HDD LED**

Indicates the status of the hard drive

**Digital I/O Terminal Block**

The Digital I/O terminal block supports 8 digital input and 8 digital output

**Reset switch**

Press to reset the system

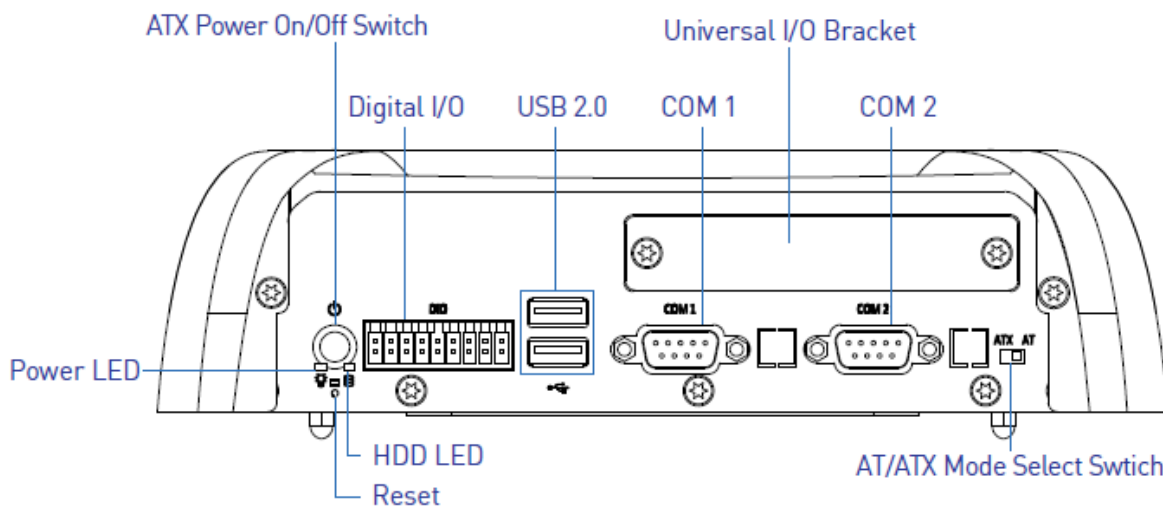

**Top****VESA Mounting Hole**

These are mounting holes for VESA mount (75x75mm and 100x100mm)

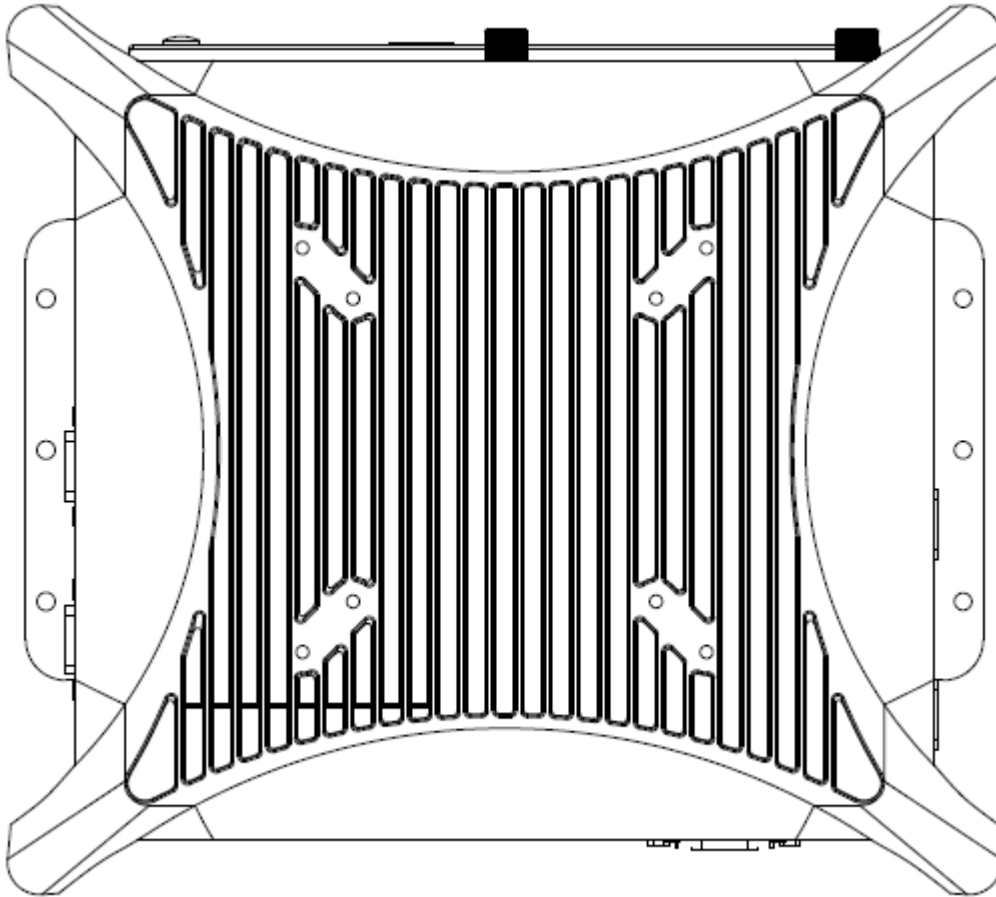



## 1.4 Mechanical Dimensions

### 1.4.1 PC100

Unit: mm

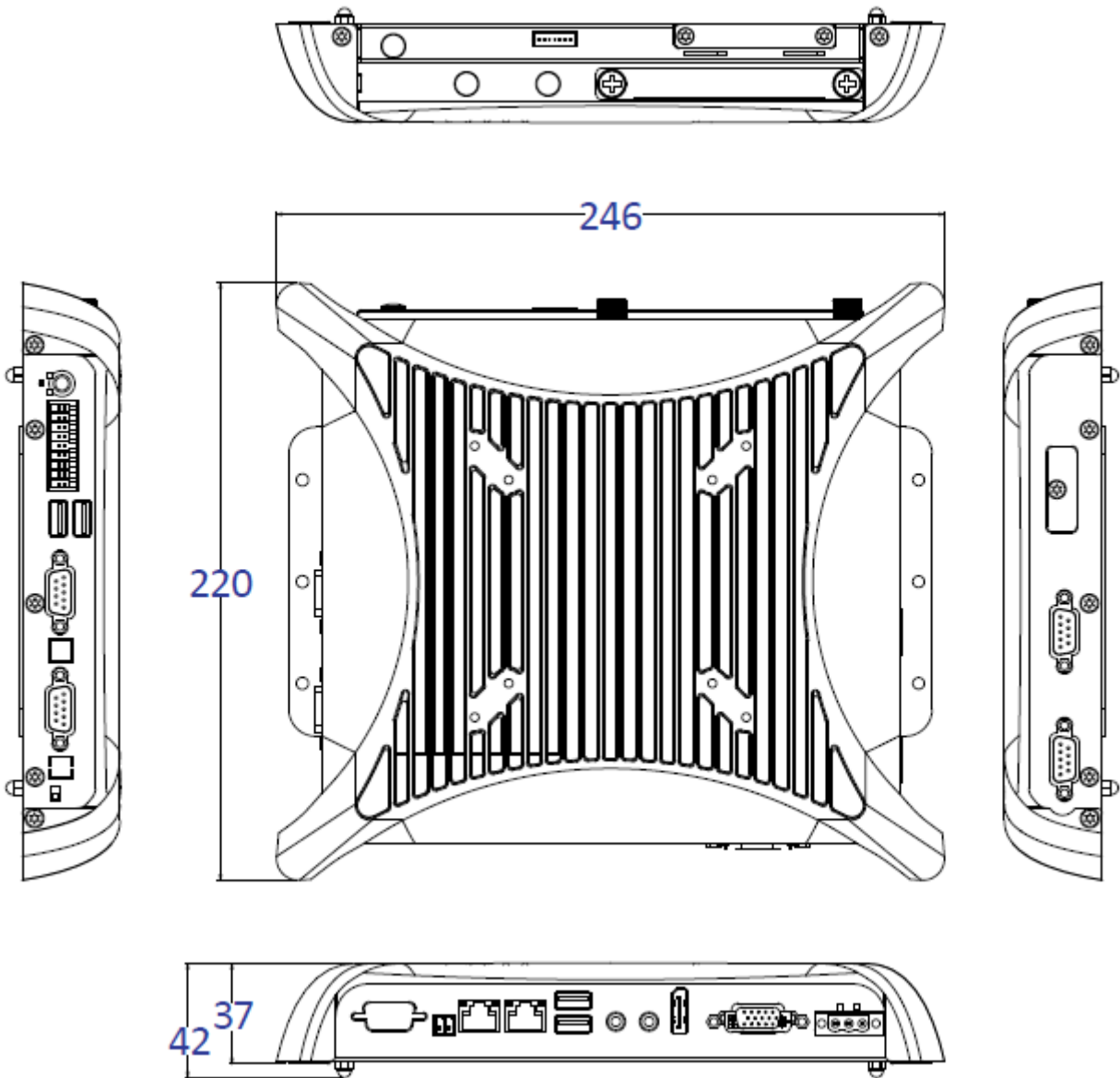

### 1.4.2 PC110

Unit: mm

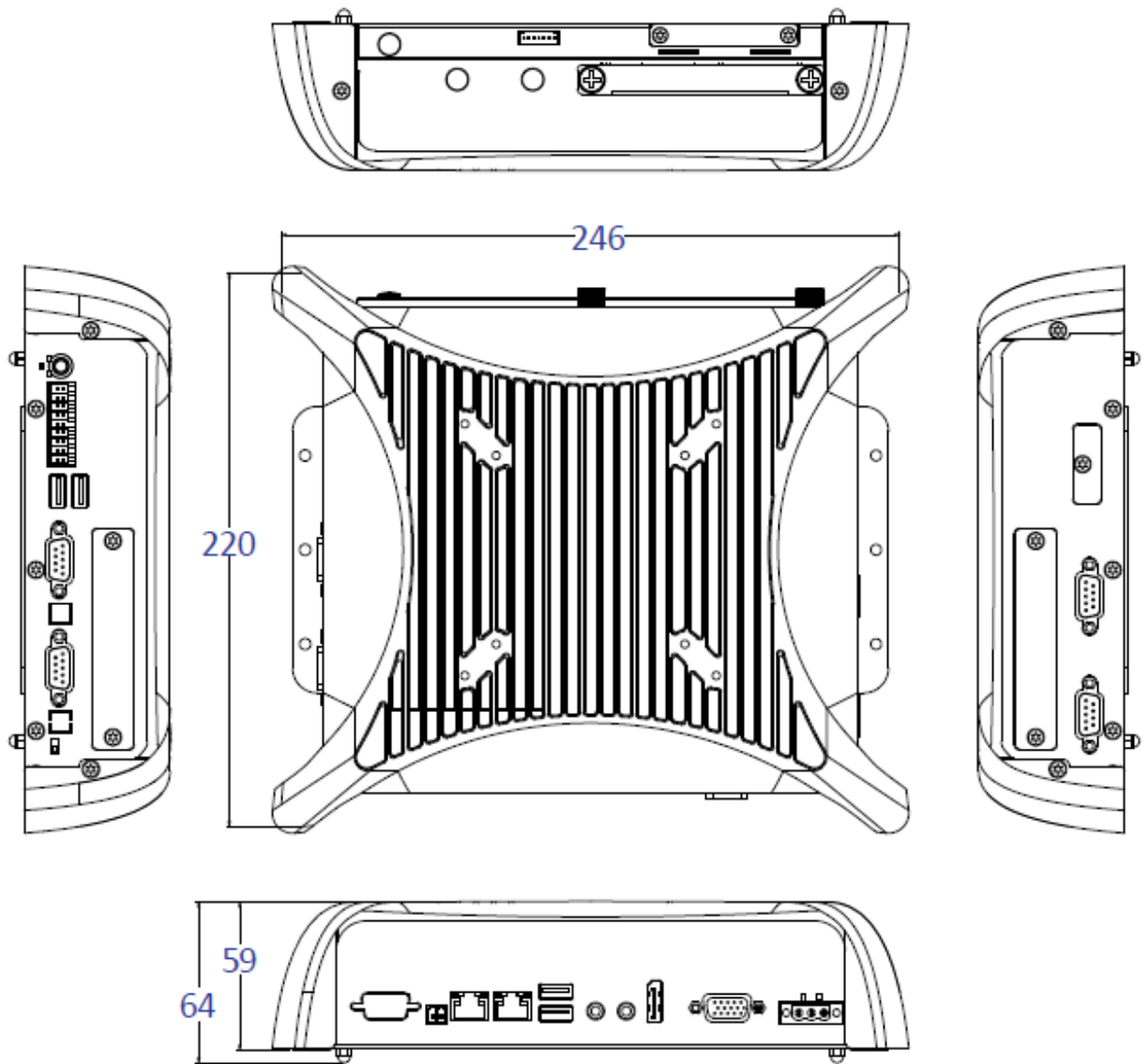

## Chapter 2

# Switches and Connectors

## 2.1 Switch and Connector Locations

### 2.1.1 Top View

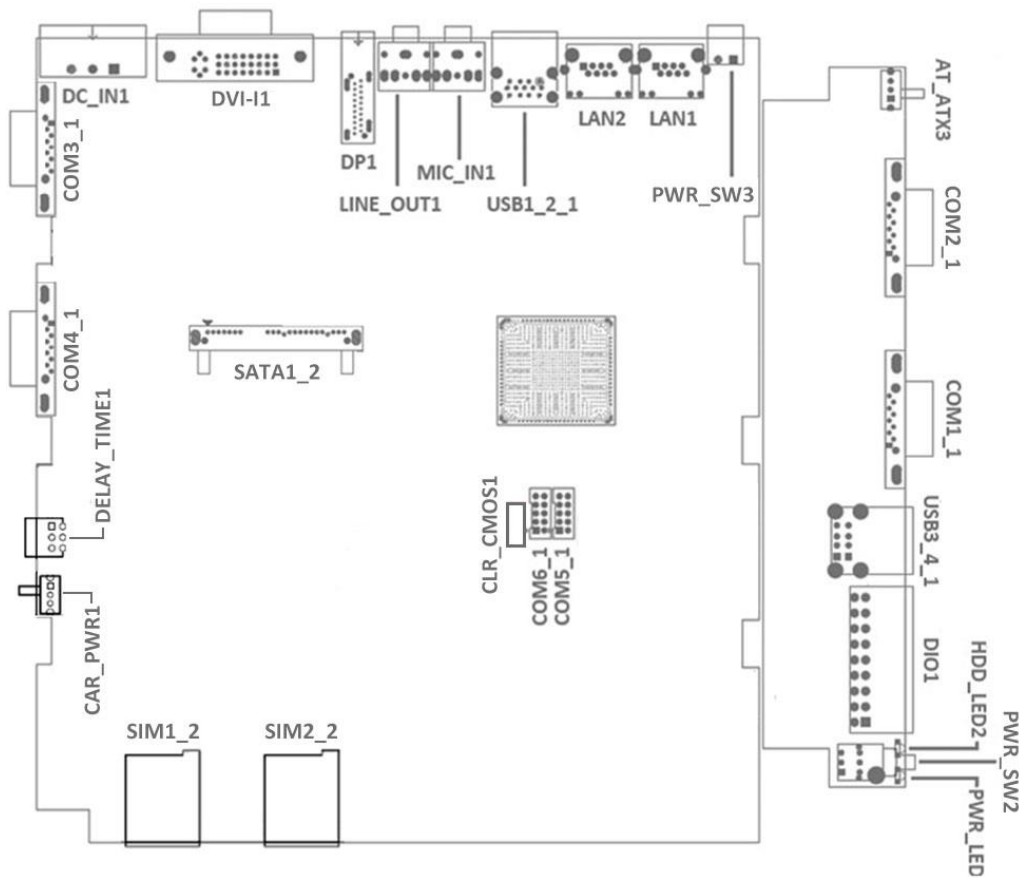

### 2.1.2 Bottom View

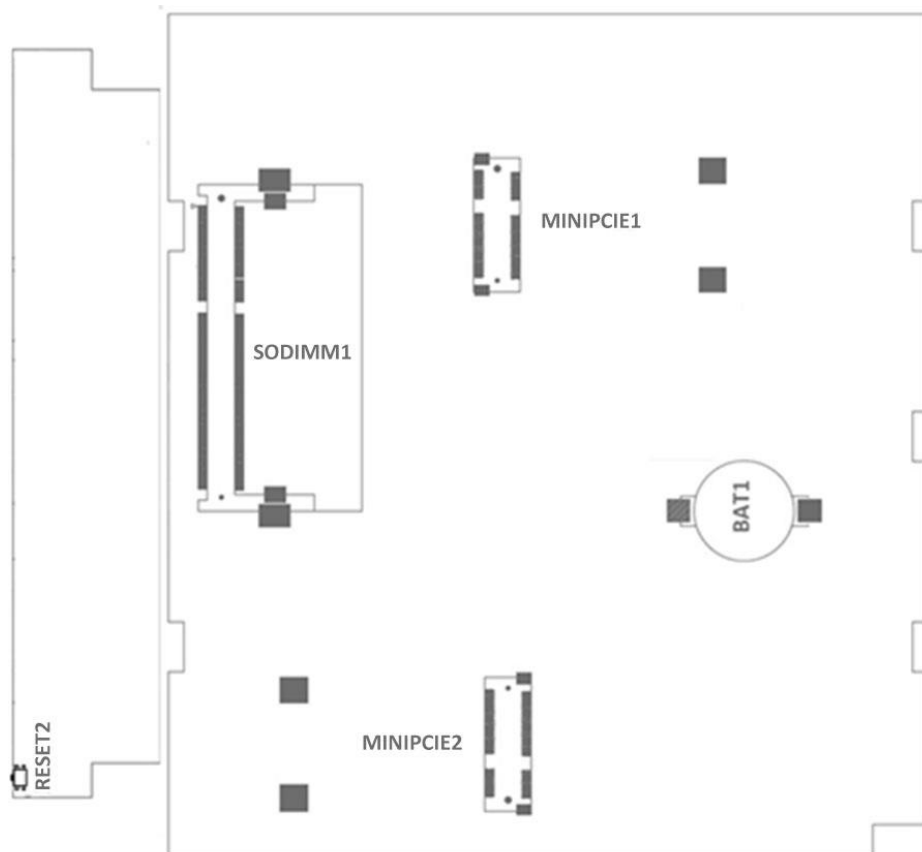

## 2.2 Connector / Switch Definition

### List of Connector / Switch

Connector Location	Definition
AT_ATX3	AT / ATX Power Mode Switch
CLR_CMOS1	Clear BIOS Switch
CAR_PWR1	PC / Car Mode Switch
DELAY_TIME2	Car mode PC turn off delay time
CFAST1_1	CFast Socket
PWR_SW2	Power Switch
RESET2	Reset Switch
USB1_2_1	USB 3.0 & USB 2.0 Port
USB3_4_1	USB 2.0 Port
SIM1_2, SIM2_2	SIM Card Socket
COM1_1, COM2_1, COM3_1, COM4_1	RS232 / RS422 / RS485 Connector
COM5_1, COM6_1	RS232 / RS422 / RS485 Connector
LAN1, LAN2	LAN Port
DC_IN1	3-pin DC 9~50V Power Input Connector
VGA1	VGA Connector
DP1	DisplayPort Connector
LINE_OUT1	Line-out Jack
MIC_IN1	Mic-in Jack
DIO1	8DI / 8DO Connector
PWR_SW3	Remote Power Switch
MINIPCIE1	Mini PCI-Express / mSATA Socket
MINIPCIE2	Mini PCI-Express Socket
SATA1_2	SATA with Power Connector
POWER1, POWER2	Power Connector
PWR_LED1	Power LED Status
HDD_LED1	HDD Access LED Status

## 2.3 Switches Definitions

### AT\_ATX3: AT / ATX Power Mode Switch

Switch	Definition
1-2 (Left)	ATX Power Mode ( Default )
2-3 (Right)	AT Power Mode

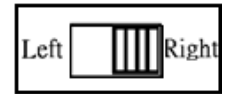

### CLR\_CMOS1: Clear BIOS Switch

Switch	Definition
Off	Normal Status (Default)
ON	Clear BIOS

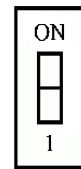

### CAR\_PWR1: PC / Car Mode Switch

Switch	Definition
1-2 (Left)	PC Power Mode ( Default )
2-3 (Right)	Power Ignition Mode

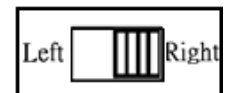

### DELAY\_TIME2: Power off delay time setup Switch

Switch 1 / 2 / 3	Definition
ON / ON / ON	3 sec. ( Default Shutdown Timer by O.S )
ON / ON / OFF	1 min.
ON / OFF / ON	5 min.
ON / OFF / OFF	10 min.
OFF / ON / ON	30 min.
OFF / ON / OFF	1 hour
OFF / OFF / ON	2 hour



### Step of Setting Power Ignition

Step 1:

To select power ignition by PC/CAR switch.

Step 2:

To configure the power off delay time, please check the Delay Time Setting Options in advance.

Step 3:

To connect the power and ignition power

Step 3

Switch 1 / 2 / 3	Power off delay time
ON / ON / ON	3 second
ON / ON / OFF	1 minute
ON / OFF / ON	5 minutes
ON / OFF / OFF	10 minutes
OFF / ON / ON	30 minutes
OFF / ON / OFF	1 hour
OFF / OFF / ON	2 hours

Step 1  
 Pin 1-2 (Right): PC Mode  
 Pin 2-3 (Left): Power Ignition Mode

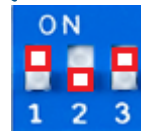

Step 3  
 To connect the battery power and ignition signal



### Example: Delay Time Setting for 5 minutes

1. If delay time set as "5 minutes"



2. The system will shut down 5 minutes later after turning off the vehicle.



## 2.4 Connectors Definitions

### CFAST1\_1: CFast Socket

Pin	Definition	Pin	Definition	Pin	Definition
S1	GND	PC1	NC	PC10	NC
S2	SATA_TXP1	PC2	GND	PC11	NC
S3	SATA_TXN1	PC3	NC	PC12	NC
S4	GND	PC4	NC	PC13	+3.3V
S5	SATA_RXN1	PC5	NC	PC14	+3.3V
S6	SATA_RXP1	PC6	NC	PC15	GND
S7	GND	PC7	GND	PC16	GND
		PC8	NC	PC17	NC
		PC9	NC		

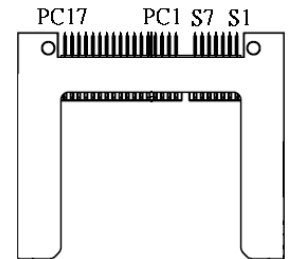

### PWR\_SW2: Power Button

Pin	Definition	Pin	Definition
1	NC	4	GND
2	Power Button	5	NC
3	NC	6	GND

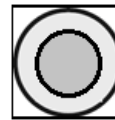

### RESET2 : Reset Button

Pin	Definition
1	RESET
2	GND



### USB1\_2\_1: USB3.0 & USB2.0 Connector, Type A

Pin	Definition	Pin	Definition
1	+5V	10	+5V
2	USB2_D0-	11	USB2_D1-
3	USB2_D0+	12	USB2_D1+
4	GND	13	GND
5	USB3_RX0-		
6	USB3_RX0+		
7	GND		
8	USB3_TX0-		
9	USB3_TX0+		

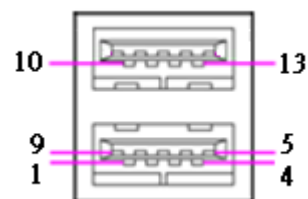



**USB3\_4\_1: USB2.0 Connector, Type A**

Pin	USB3_4_1 Definition
1	+5V
2	USB2_D2-
3	USB2_D2+
4	GND
5	+5V
6	USB2_D3-
7	USB2_D3+
8	GND

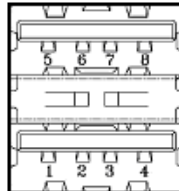

**SIM1\_2, SIM2\_2 : SIM Card Socket**

Pin	Definition	Pin	Definition
C1	UIM_PWR	C6	UIM_VPP
C2	UIM_RESET	C7	UIM_DATA
C3	UIM_CLK	CD	NC
C5	GND	COM	GND

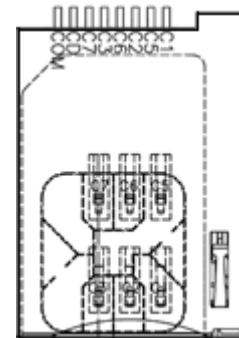

**COM1\_1: RS232 / RS422 / RS485 Connector**

Connector Type: 9-pin D-Sub

Pin	RS232 Definition	RS422 / 485 Full Duplex Definition	RS485 Half Duplex Definition
1	DCD1	TX1-	DATA1-
2	RXD1	TX1+	DATA1+
3	TXD1	RX1+	
4	DTR1	RX1-	
5	GND	GND	GND
6	DSR1		
7	RTS1		
8	CTS1		
9	RI1		

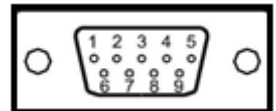
**COM2\_1: RS232 / RS422 / RS485 Connector**

Connector Type: 9-pin D-Sub

Pin	RS232 Definition	RS422 / 485 Full Duplex Definition	RS485 Half Duplex Definition
1	DCD2	TX2-	DATA2-
2	RXD2	TX2+	DATA2+
3	TXD2	RX2+	
4	DTR2	RX2-	
5	GND	GND	GND
6	DSR2		
7	RTS2		
8	CTS2		
9	RI2		

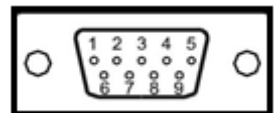

**COM3\_1 : RS232 / RS422 / RS485 Connector**

Connector Type: 2X5 10-pin box header, 2.54mm pitch

COM3_1			
Pin	RS232 Definition	RS422 / 485 Full Duplex Definition	RS485 Half Duplex Definition
1	DCD3	TX3-	DATA3-
2	RXD3	TX3+	DATA3+
3	TXD3	RX3+	
4	DTR3	RX3-	
5	GND	GND	GND
6	DSR3		
7	RTS3		
8	CTS3		
9	RI3		

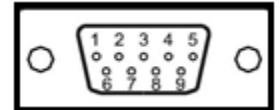
**COM4\_1 : RS232 / RS422 / RS485 Connector**

Connector Type: 2X5 10-pin box header, 2.54mm pitch

COM4_1			
Pin	RS232 Definition	RS422 / 485 Full Duplex Definition	RS485 Half Duplex Definition
1	DCD4	TX4-	DATA4-
2	RXD4	TX4+	DATA4+
3	TXD4	RX4+	
4	DTR4	RX4-	
5	GND	GND	GND
6	DSR4		
7	RTS4		
8	CTS4		
9	RI4		

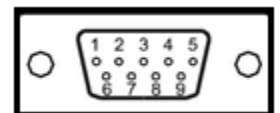

**COM5\_1 : RS232 / RS422 / RS485 Connector**

Connector Type: 2X5 10-pin box header, 2.54mm pitch

COM3_1			
Pin	RS232 Definition	RS422 / 485 Full Duplex Definition	RS485 Half Duplex Definition
1	DCD5	TX5-	DATA5-
2	RXD5	TX5+	DATA5+
3	TXD5	RX5+	
4	DTR5	RX5-	
5	GND	GND	GND
6	DSR5		
7	RTS5		
8	CTS5		
9	RI5		

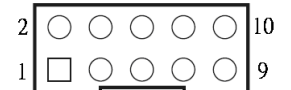

**COM6\_1 : RS232 / RS422 / RS485 Connector**

Connector Type: 2X5 10-pin box header, 2.54mm pitch

COM4_1			
Pin	RS232 Definition	RS422 / 485 Full Duplex Definition	RS485 Half Duplex Definition
1	DCD6	TX6-	DATA6-
2	RxD6	TX6+	DATA6+
3	TxD6	RX6+	
4	DTR6	RX6-	
5	GND	GND	GND
6	DSR6		
7	RTS6		
8	CTS6		
9	RI6		

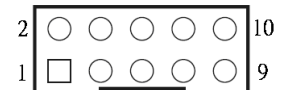

**LAN1, LAN2: RJ45 with LEDs Port**

Connector Type: RJ45 Connector

Pin	Definition	Pin	Definition
1	LAN1_MDI0P	5	LAN1_MDI2N
2	LAN1_MDI0N	6	LAN1_MDI1N
3	LAN1_MDI1P	7	LAN1_MDI3P
4	LAN1_MDI2P	8	LAN1_MDI3N

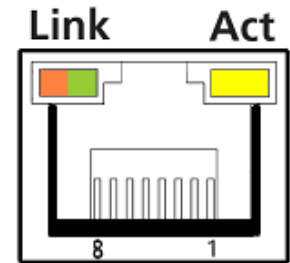

Pin	Definition	Pin	Definition
1	LAN2_MDI0P	5	LAN2_MDI2N
2	LAN2_MDI0N	6	LAN2_MDI1N
3	LAN2_MDI1P	7	LAN2_MDI3P
4	LAN2_MDI2P	8	LAN2_MDI3N

Link LED Status	Definition	Act LED Status	Definition
Steady Orange	1Gbps Network Link	Blinking Yellow	Data Activity
Steady Green	100Mbps Network Link	Off	No Activity
Off	10Mbps Network Link		

**DC\_IN1: DC Power Input Connector (+9~50V)**

Connector Type: Terminal Block 1X3 3-pin, 5.0mm pitch

Pin	Definition
1	+9~50VIN
2	Power Ignition
3	GND

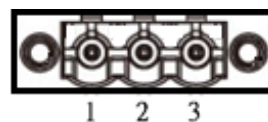

**VGA1: VGA Connector**

Pin	Definition	Pin	Definition
1	RED	9	+5V
2	GREEN	10	GND
3	BLUE	11	NC
4	NC	12	DDC_SDA
5	GND	13	HSYNC
6	RED_GND	14	VSYNC
7	GREEN_GND	15	DDC_SCL
8	BLUE_GND		

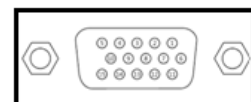

**DP1: DisplayPort Connector**

Pin	Definition	Pin	Definition
1	DP_LANE0_P	11	GND
2	GND	12	DP_LANE3_N
3	DP_LANE0_N	13	GND
4	DP_LANE1_P	14	GND
5	GND	15	DP_AUX_P
6	DP_LANE1_N	16	GND
7	DP_LANE2_P	17	DP_AUX_N
8	GND	18	DP_HPD
9	DP_LANE2_N	19	GND
10	DP_LANE3_P	20	DP_PWR



**LINE\_OUT1 : Line-out Jack (Green)**

Connector Type: 5-pin Phone Jack

Pin	Definition
1	GND
2	OUT_R
3	NC
4	GND
5	OUT_L



**MIC\_IN1: Microphone Jack (Pink)**

Connector Type: 5-pin Phone Jack

Pin	Definition
1	GND
2	MIC_R
3	NC
4	GND
5	MIC_L



**DIO1: Digital Input / Output Connector**

Connector Type: Terminal Block 2X9 18-pin, 3.5mm pitch

Pin	Definition	Pin	Definition
1	DI1	2	DO1
3	DI2	4	DO2
5	DI3	6	DO3
7	DI4	8	DO4
9	DI5	10	DO5
11	DI6	12	DO6
13	DI7	14	DO7
15	DI8	16	DO8
17	External DC INPUT	18	External GND

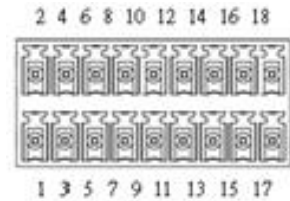

**Reference Input Circuit**

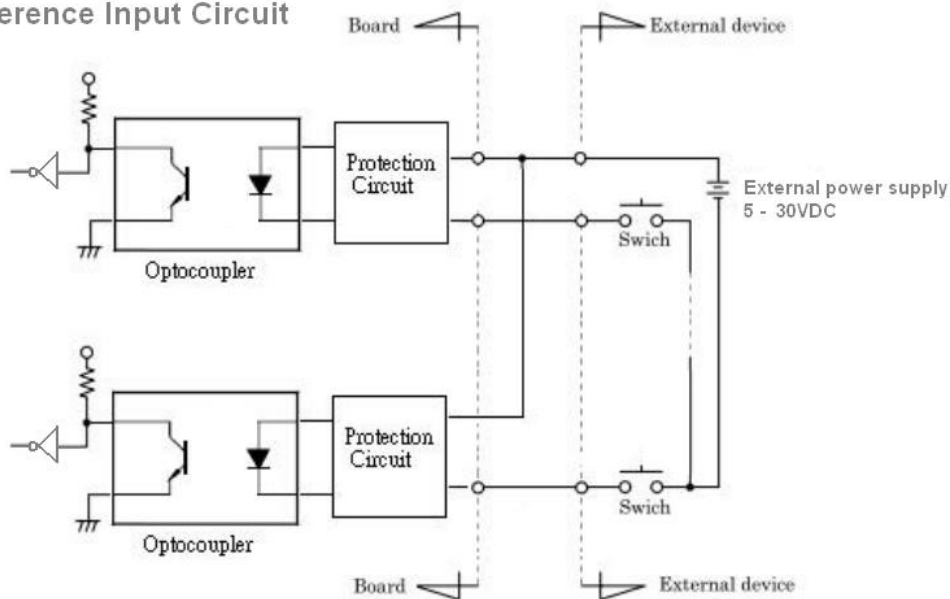

**External Output Circuit**

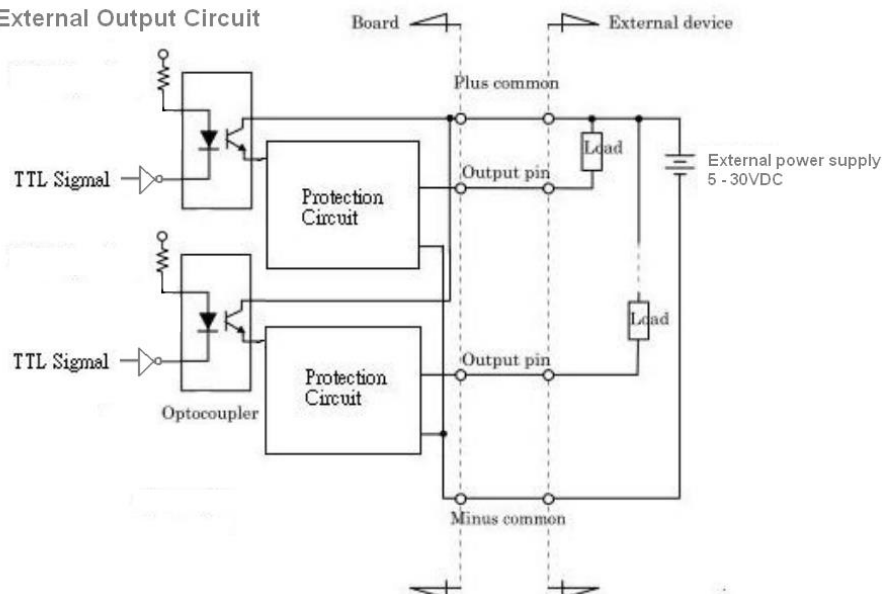

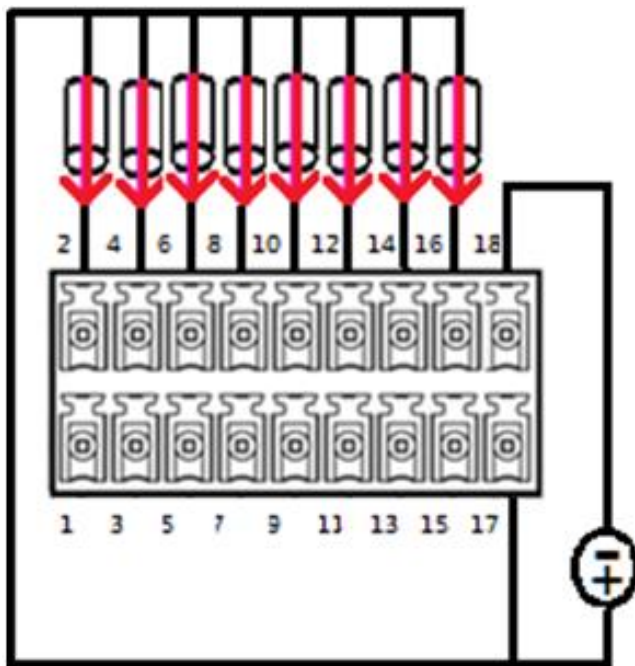
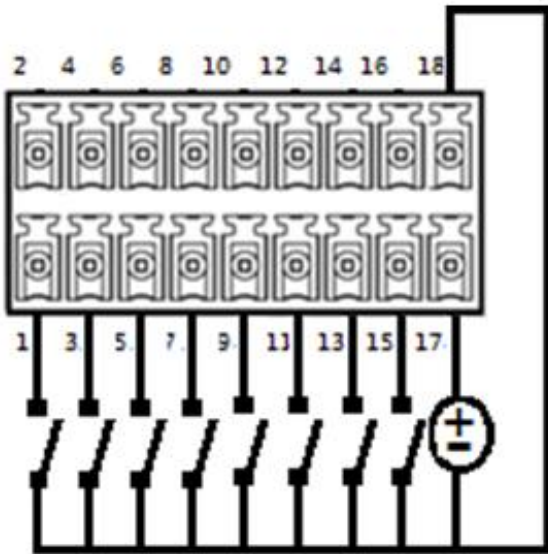

**PWR\_SW3 : Remote Power Switch**

Connector Type: Terminal Block 1X2 2-pin, 3.5mm pitch

Pin	Definition
1	Power Button
2	GND





**MINIPCIE1: Mini PCI-Express / mSATA Socket**

Pin	Definition	Pin	Definition	Pin	Definition
1	WAKE#	19	NC	37	GND
2	+3.3V	20	+3.3V	38	USB_D4+
3	NC	21	GND	39	+3.3V
4	GND	22	PCIE_RST#	40	GND
5	NC	23	PCIE_RXN3 (SATA_RXN1)	41	+3.3V
6	+1.5V	24	+3.3V	42	NC
7	CLKREQ3#	25	PCIE_RXP3 (SATA_RXP1)	43	GND
8	USIM1_VCC	26	GND	44	NC
9	GND	27	GND	45	NC
10	USIM1_DATA	28	+1.5V	46	NC
11	PCIE_CLKN3	29	GND	47	NC
12	USIM1_CLK	30	SMB_CLK	48	+1.5V
13	PCIE_CLKP3	31	PCIE_TXN3 (SATA_TXN1)	49	NC
14	USIM1_RST	32	SMB_DATA	50	GND
15	GND	33	PCIE_TXP3 (SATA_TXP1)	51	NC
16	USIM1_VPP	34	GND	52	+3.3V
17	NC	35	GND		
18	GND	36	USB_D4-		

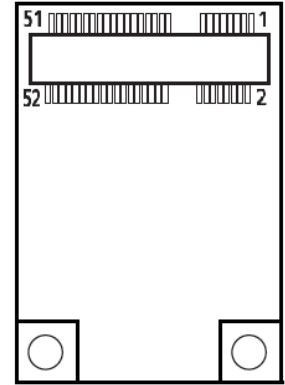
**MINIPCIE2: Mini PCI-Express**

Pin	Definition	Pin	Definition	Pin	Definition
1	WAKE#	19	NC	37	GND
2	+3.3V	20	+3.3V	38	USB_D6+
3	NC	21	GND	39	+3.3V
4	GND	22	MINIPCIE_RST#	40	GND
5	NC	23	PCIE_RXN4	41	+3.3V
6	+1.5V	24	+3.3V	42	NC
7	CLKREQ4#	25	PCIE_RXP4	43	GND
8	USIM2_VCC	26	GND	44	NC
9	GND	27	GND	45	NC
10	USIM2_DATA	28	+1.5V	46	NC
11	PCIE_CLKN4	29	GND	47	NC
12	USIM2_CLK	30	SMB_CLK	48	+1.5V
13	PCIE_CLKP4	31	PCIE_TXN4	49	NC
14	USIM2_RST	32	SMB_DATA	50	GND
15	GND	33	PCIE_TXP4	51	NC
16	USIM2_VPP	34	GND	52	+3.3V
17	NC	35	GND		
18	GND	36	USB_D6-		

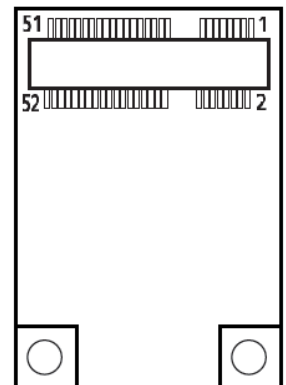

**SATA1\_2: SATA with Power Connector**

Pin	SATA1_1 Definition	Pin	SATA1_1 Definition	Pin	SATA2 Definition	Pin	SATA2 Definition
1	GND	12	GND	1	GND	12	GND
2	SATA_TXP0	13	GND	2	SATA_TXP1	13	GND
3	SATA_TXN0	14	+5V	3	SATA_TXN1	14	+5V
4	GND	15	+5V	4	GND	15	+5V
5	SATA_RXN0	16	+5V	5	SATA_RXN1	16	+5V
6	SATA_RXP0	17	GND	6	SATA_RXP1	17	GND
7	GND	18	GND	7	GND	18	GND
8	+3.3V	19	GND	8	+3.3V	19	GND
9	+3.3V	20	+12V	9	+3.3V	20	+12V
10	+3.3V	21	+12V	10	+3.3V	21	+12V
11	GND	22	+12V	11	GND	22	+12V



**POWER1, POWER2: Power Connector**

Connector Type: 1X4-pin Wafer, 2.0mm pitch

Pin	Definition
1	+5V
2	GND
3	GND
4	+12V

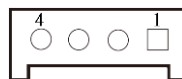

**PWR\_LED1: Power LED Status**

Pin	Definition
1	POWER LED+
2	POWER LED-



**HDD\_LED1: HDD Access LED Status**

Pin	Definition
1	HDD LED+
2	HDD LED-



## Chapter 3

# System Setup

## 3.1 Set torque force to 3.5 kgf-cm to execute all the screwing and unscrewing



### WARNING

In order to prevent electric shock or system damage, before removing the chassis cover, must turn off power and disconnect the unit from power source.

## 3.2 Installing SODIMM

1. Remove SODIMM cover in the below circled area for installing memory module.

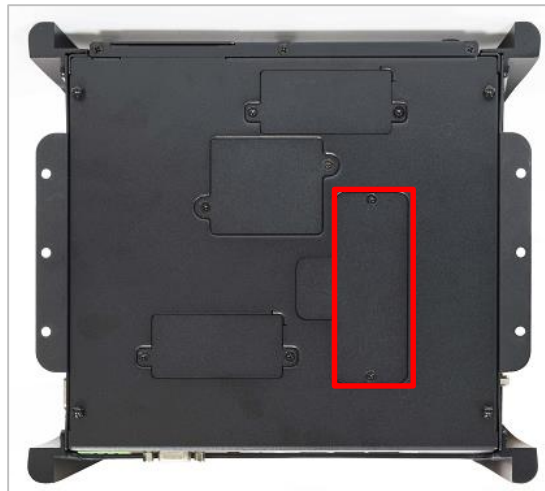

2. Insert memory module from 45 degree direction.



3. Press the memory module vertically downward until you hear the "click" sound. Make sure the memory module is firmly in place.



### 3.3 Installing mini PCIe card / mSATA

1. Two mini PCIe slots are available for PC100 series. MiniPCIE1 supports mSATA.

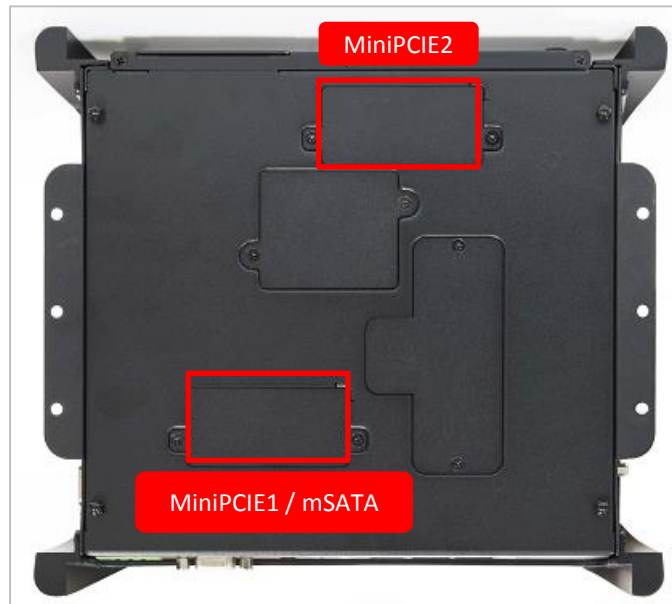

2. Insert mini PCIe card or mSATA module from 45 degree direction.



3. Press the mini PCIe card or mSATA module down and lock it with two screws (M2x3.7L).



### 3.4 Installing HDD on removable STAT HDD bay

1. One removable SATA HDD bays is available for PC100 Series



2. Unscrew the two sun screws circled below to take out the removable SATA HDD bay.



3. Lock the 2.5" HDD with HDD bracket using four screws (M3x4L).

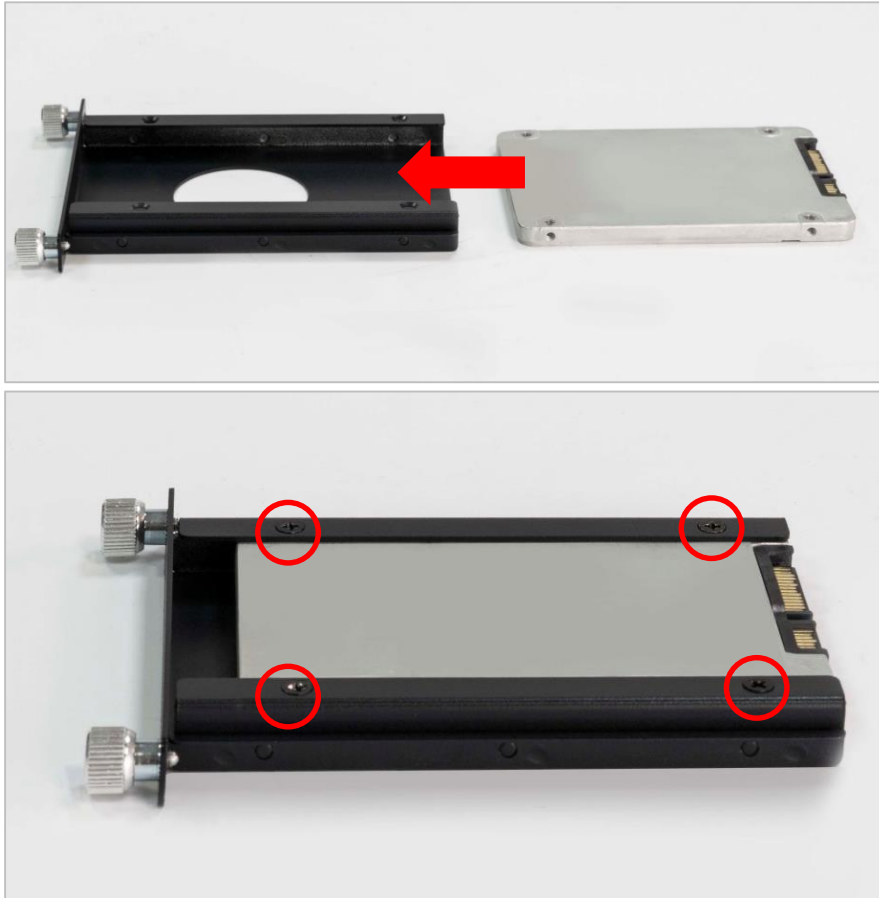

4. Slide the HDD bracket back and then fasten the sun screws.





### 3.5 Installing CFast card

1. One CFast socket is available for PC100 series. Unscrew two screws to remove the bracket.



2. Insert CFast card into the socket until you hear the “click” sound.



3. The socket is push-push type. Push the installed CFast card again to remove it.





## 3.6 Installing SIM card

1. For PC100 Series, two SIM card slots are available on system chassis between removable HDD bay and CFast slot.



2. Press the SIM card in until you hear the “click” sound.



3. Please note that the installation of SIM 1 and SIM 2 has to match the installation of mini PCIe slots.

SIM Card Socket Number	Matching Mini PCIe Slot
SIM 1	MiniPCI E1 / mSATA
SIM 2	MiniPCI E2

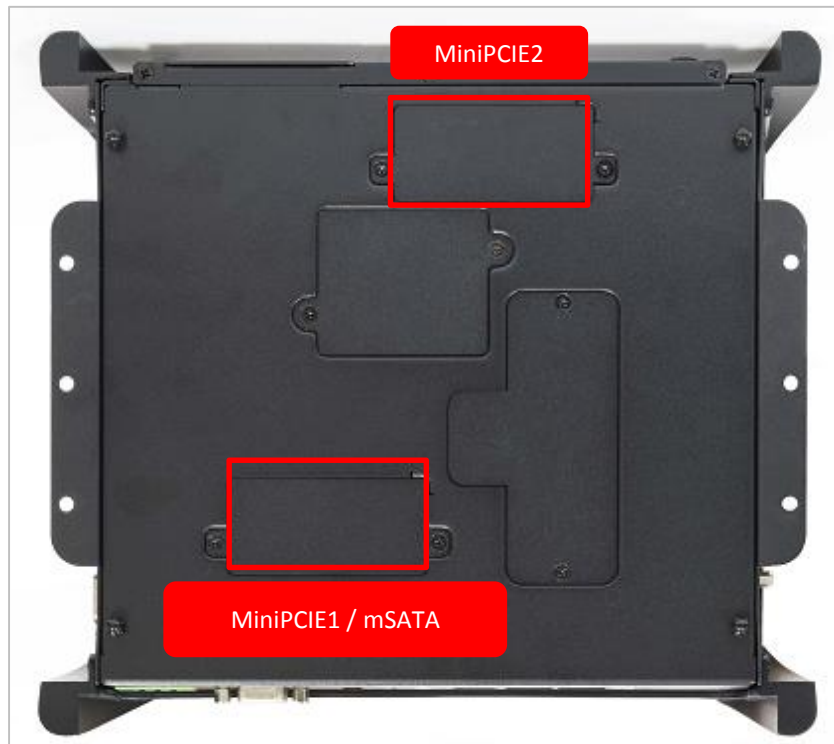

4. To uninstall SIM card, simply press the installed SIM card and then the card will be pushed out

### 3.7 Removing chassis bottom cover

1. Unscrew the 6 screws (M3x5L) below.



2. Remove the top cover of PC module.



### 3.8 Installing antenna

1. Three antenna holes are available for PC100 series.





2. Remove antenna hole cover on the system panel.



3. Have antenna jack penetrate through the hole.



- Put on washer and fasten the nut with antenna jack.



- Attach the RF connector at the cable-end onto the communication module.



6. Assemble the antenna and antenna jack together.



### 3.9 Assemble chassis top cover

1. Ensure thermal pad is in place on the CPU thermal block.



2. Close the chassis top cover following the below direction and make sure the aluminum part on the top cover is touching the thermal pad on CPU thermal block.





3. Fasten the six screws (M3X5L) to lock the system body with top cover.





### 3.10 Connecting PC module with VIO display module

1. Hold the PC module with its connector facing towards the connector on the back of VIO display module.



2. Press the PC module downward to ensure two modules are firmly connected.



3. Lock the below 6 screws (M4X5L) to finish assembly.



## Chapter 4

# BIOS Setup

## 4.1 BIOS Introduction

The system BIOS software is stored on EEPROM. The BIOS provides an interface to modify the configuration. When the battery is removed, all the parameters will be reset.

### BIOS Setup

Power on the embedded system and by pressing <Del> or <F2> immediately allows you to enter the setup screens. If the message disappears before you respond and you still wish to enter the Setup, restart the system by turning it OFF and ON or pressing the RESET button.

You may also restart the system by simultaneously pressing <Ctrl>, <Alt>, and <Delete> keys.

Control Keys	
<←> <→>	Select Screen
<↑> <↓>	Select Item
<Enter>	Select
<Page Up/+>	Increases the numeric value or makes changes
<Page Down/->	Decreases the numeric value or makes changes
<F1>	General Help
<F2>	Previous Value
<F3>	Load Optimized Defaults
<F4>	Save Configuration and Exit
<Tab>	Select Setup Fields
<Esc>	Exit BIOS Setup

### Main Setup

The main menu lists the setup functions you can make changes to. You can use the arrow keys ( ↑ ↓ ) to select the item. The on-line description of the highlighted setup function is displayed at the bottom of the screen.

### General Help <F1>

The BIOS setup program provides a General Help screen. You can call up this screen from any menu by simply pressing <F1>. The Help screen lists the appropriate keys to use and the possible selections for the highlighted item. Press <Esc> to exit the Help screen.

## 4.2 Main Setup

Press <Del> to enter BIOS CMOS Setup Utility. The Main setup screen is showed as following when the setup utility is entered. System Date/Time is set up in the Main Menu.



### 4.2.1 System Date

Set the system date. Please use <Tab> to switch between data elements.

### 4.2.2 System Time

Set the system time. Please use <Tab> to switch between time elements.

## 4.3 Advanced Setup

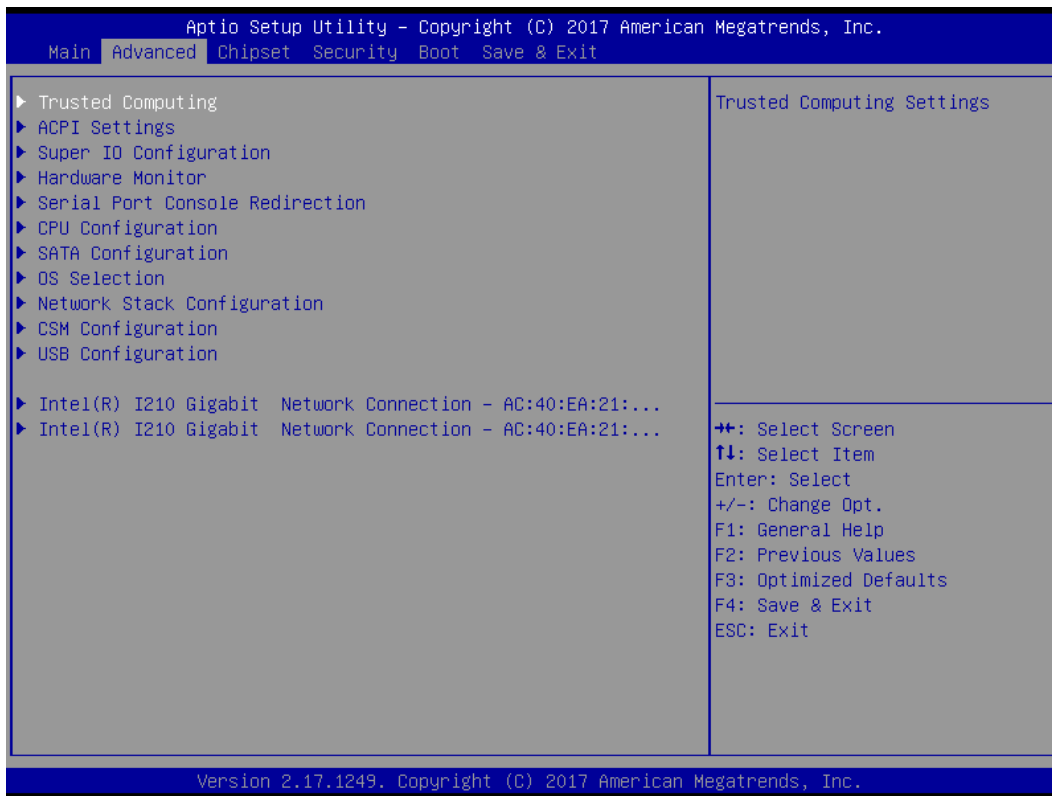

### 4.3.1 Trusted Computing (Optional)

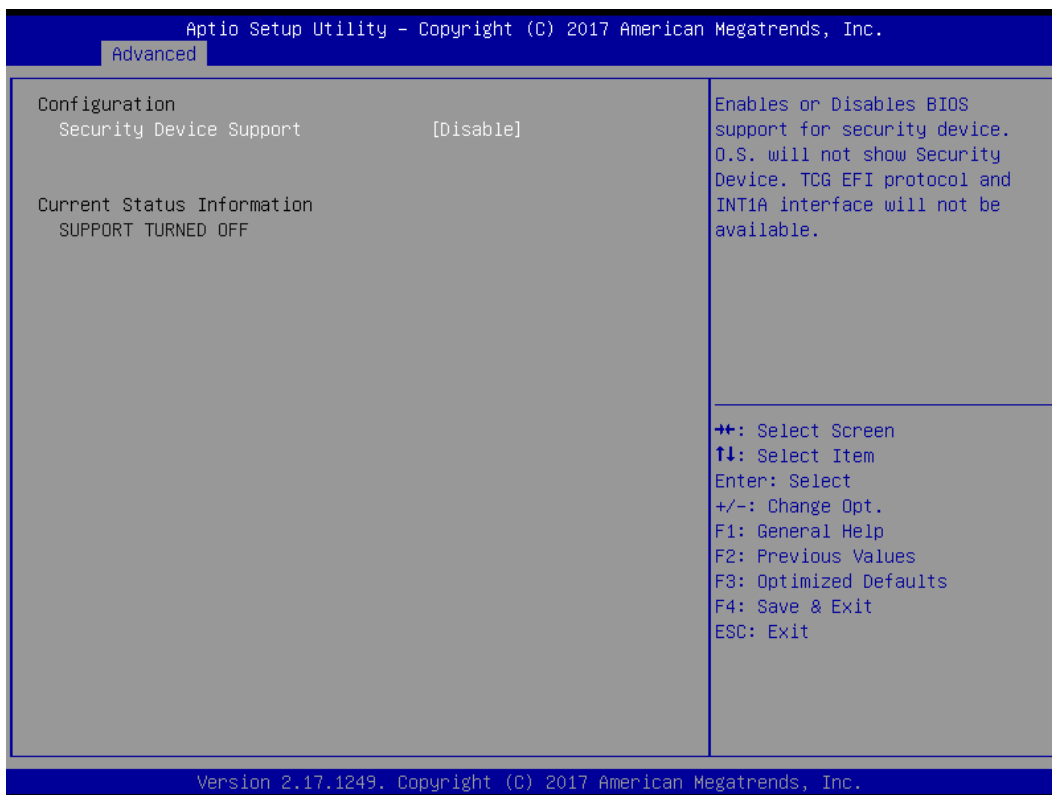

#### ■ Security Device Support

Enable or disable TPM function

### 4.3.2 ACPI Settings

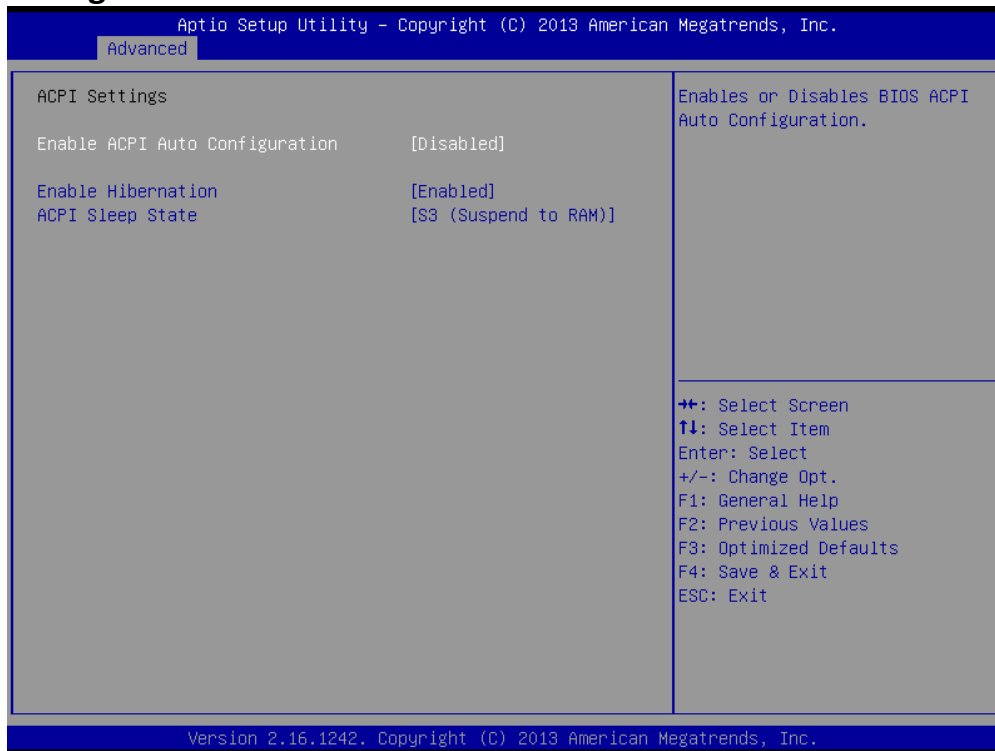

#### ■ Enable ACPI Auto Configuration

This item allows you to enable or disable BIOS ACPI Auto Configuration.

#### ■ Enable Hibernation

This item allows you to enable or disable system ability to hibernate.

#### ■ ACPI Sleep State

This item selects the highest ACPI sleep state the system will enter when the suspend button is pressed. Select <Suspend Disabled> or <S3 (Suspend to RAM)>.

### 4.3.3 Super IO Configuration

This setting allows you to select options for the Super IO Configuration, and change the value of the selected option.

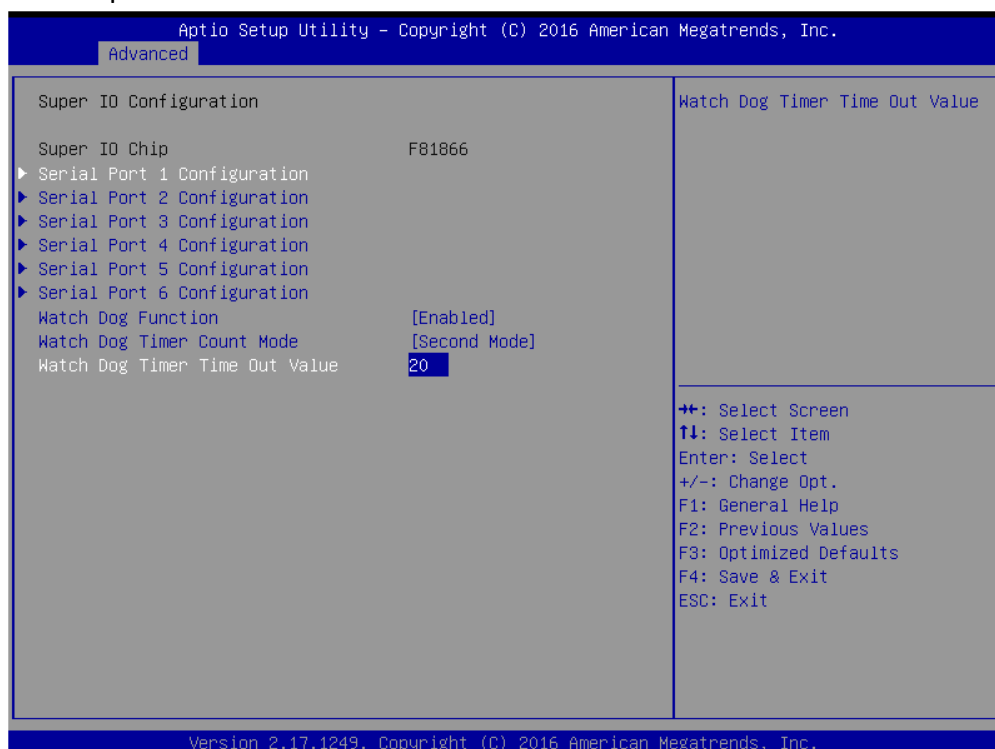

## Serial Port 1 Configuration

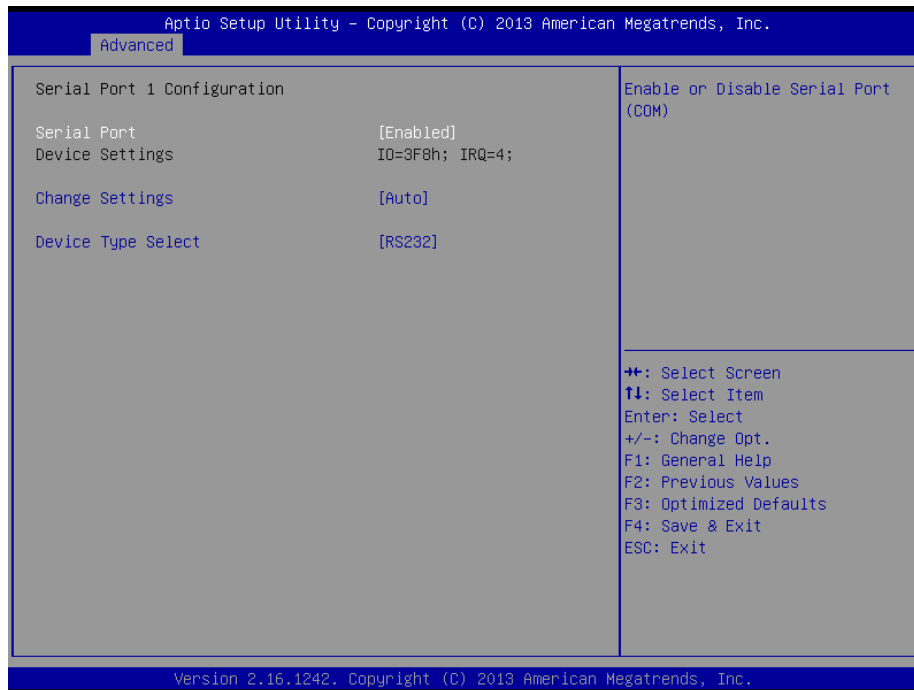

- **Serial Port**  
This item allows you to enable or disable serial port.
- **Change Settings**  
This item allows you to change the address & IRQ settings of the specified serial port.
- **Device Type Select**  
Change the Serial interface. Select <RS232> ,<RS422 Full Duplex> or <RS485 Half Duplex> interface.

## Serial Port 2 Configuration

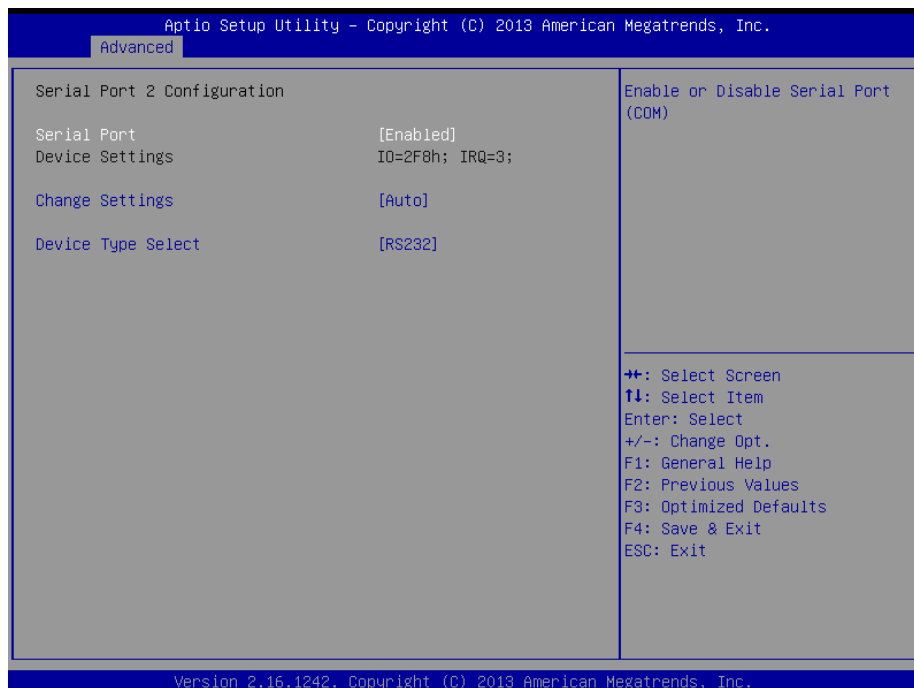

- **Serial Port**  
This item allows you to enable or disable serial port.
- **Change Settings**  
This item allows you to change the address & IRQ settings of the specified serial port.
- **Device Type Select**  
Change the Serial interface. Select <RS232> ,<RS422 Full Duplex> or <RS485 Half Duplex> interface.



### Serial Port 3 Configuration

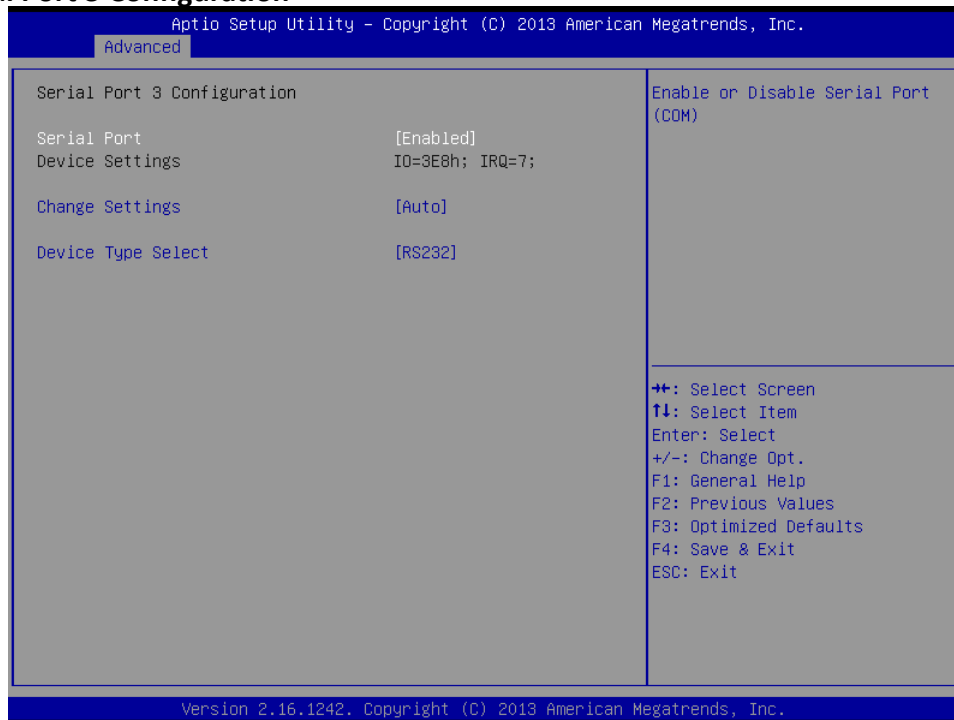

- **Serial Port**  
This item allows you to enable or disable serial port.
- **Change Settings**  
This item allows you to change the address & IRQ settings of the specified serial port.
- **Device Type Select**  
Change the Serial interface. Select <RS232> ,<RS422 Full Duplex> or <RS485 Half Duplex> interface.

### Serial Port 4 Configuration

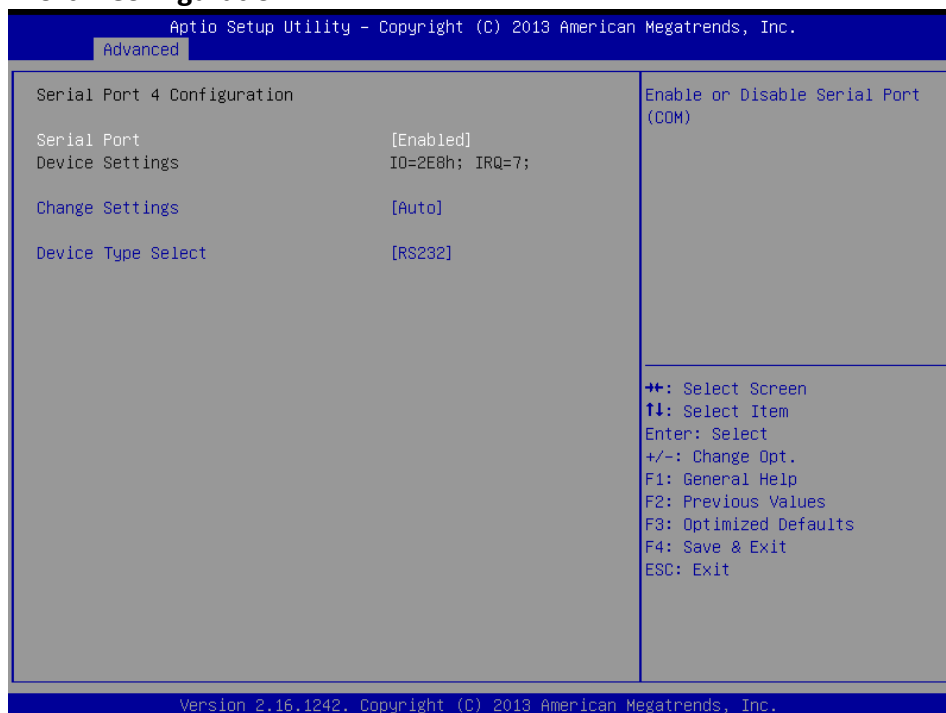

- **Serial Port**  
This item allows you to enable or disable serial port.
- **Change Settings**  
This item allows you to change the address & IRQ settings of the specified serial port.
- **Device Type Select**  
Change the Serial interface. Select <RS232> ,<RS422 Full Duplex> or <RS485 Half Duplex> interface.

## Serial Port 5 Configuration

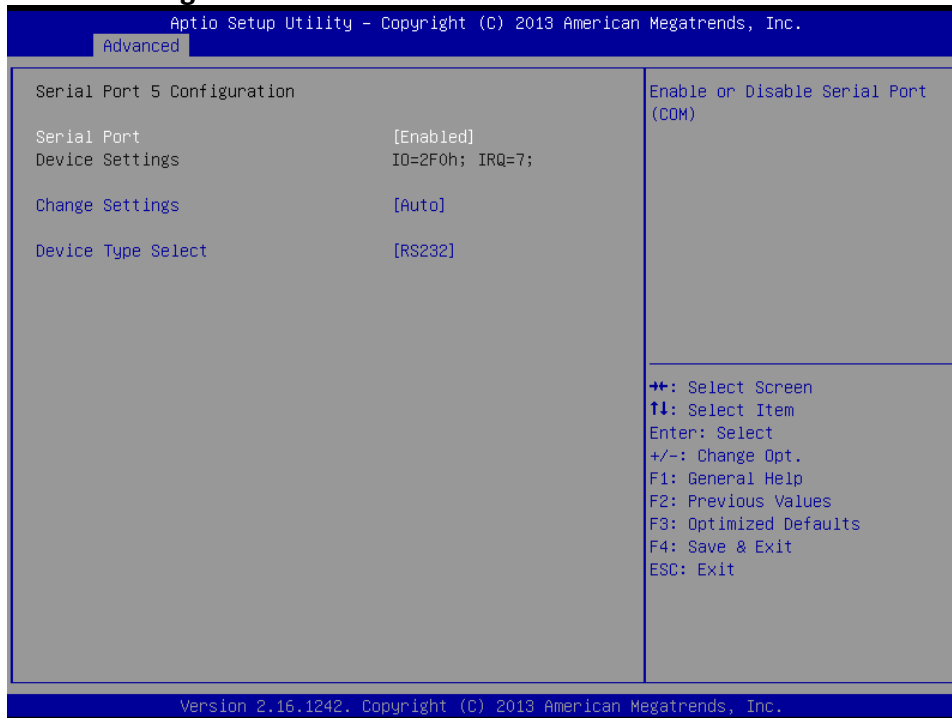

- **Serial Port**  
This item allows you to enable or disable serial port.
- **Change Settings**  
This item allows you to change the address & IRQ settings of the specified serial port.
- **Device Type Select**  
Change the Serial interface. Select <RS232> ,<RS422 Full Duplex> or <RS485 Half Duplex> interface.

## Serial Port 6 Configuration

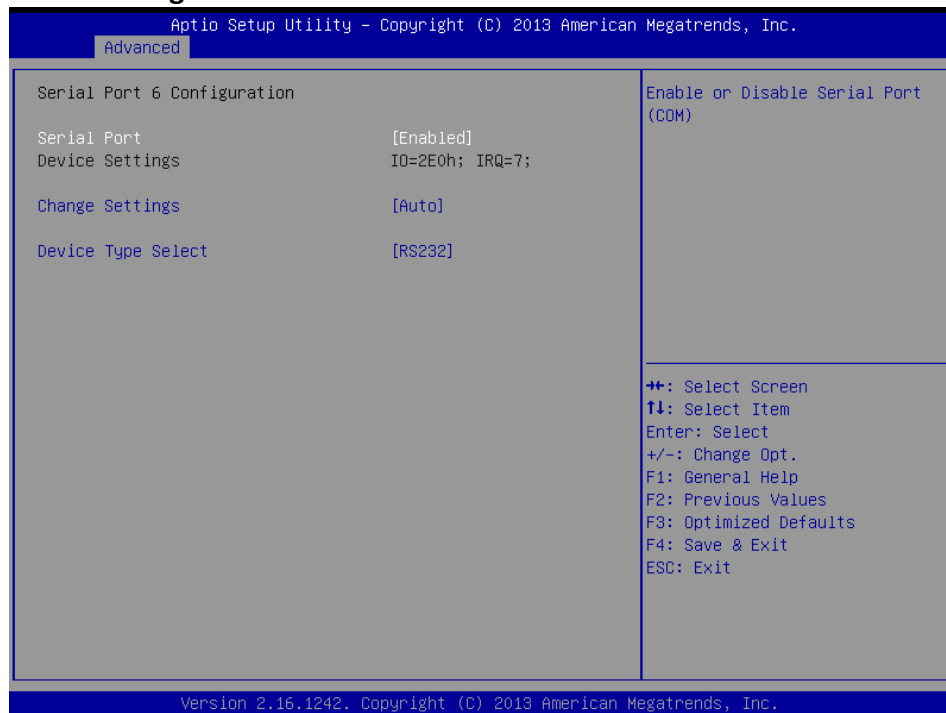

- **Serial Port**  
This item allows you to enable or disable serial port.
- **Change Settings**  
This item allows you to change the address & IRQ settings of the specified serial port.
- **Device Type Select**  
Change the Serial interface. Select <RS232> ,<RS422 Full Duplex> or <RS485 Half Duplex> interface.

### ■ Watch Dog Function

This setting allows you to setup the system watch-dog timer, a hardware timer that generates a reset when the software that it monitors does not respond as expected each time the watch dog polls it.

- **Watch Dog Timer Count Mode**

Change the Watch dog mode. Select <Second Mode> or <Minute Mode> mode.

- **Watch Dog Timer Time Out Value**

User can set a value in the range of 20 to 255.

### 4.3.4 Hardware Monitor

These items display the current status of all monitored hardware devices/ components such as voltages and temperatures.

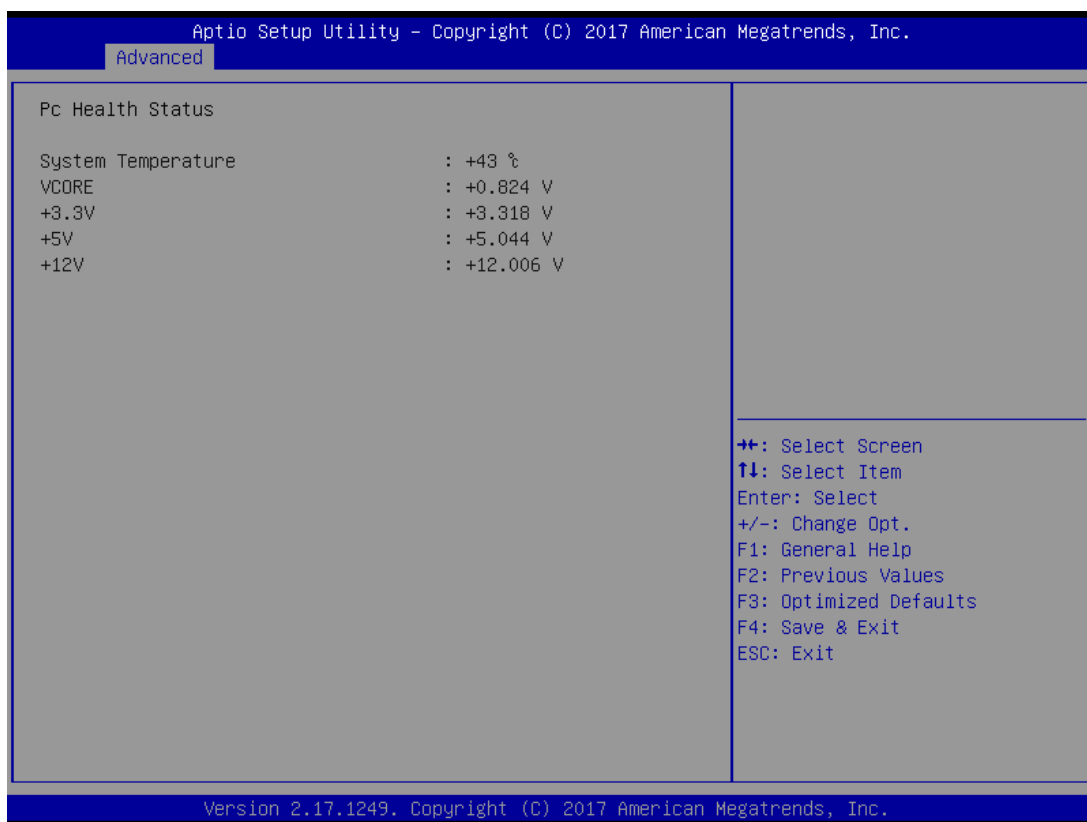

### 4.3.5 Serial Port Console Redirection

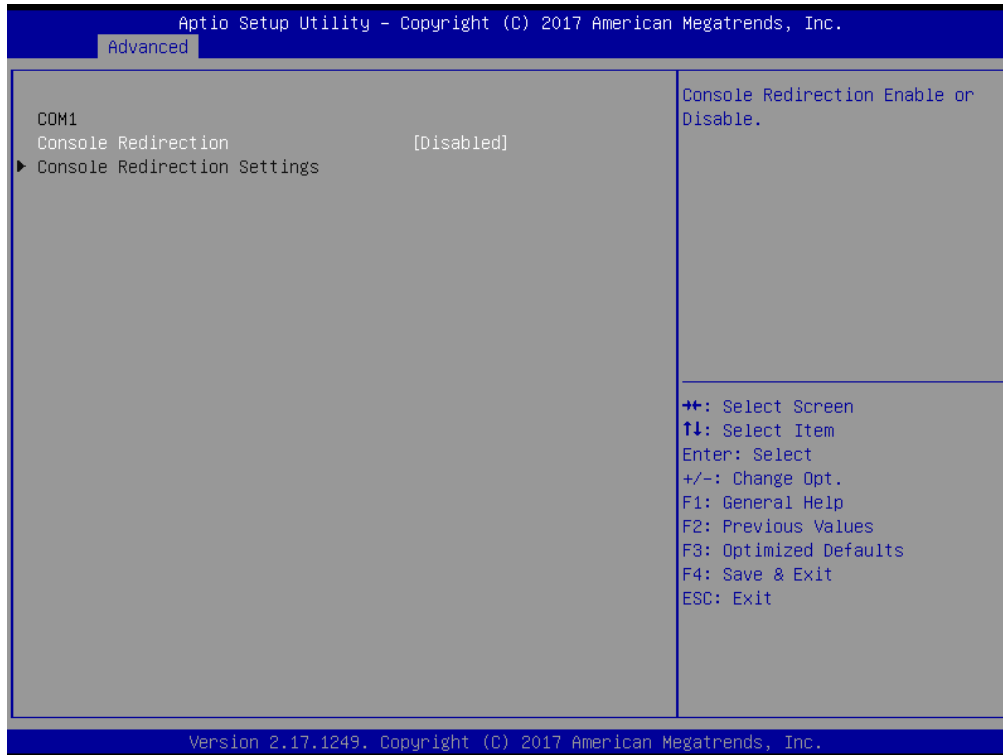

#### ■ Console Redirection

These items allow you to enable or disable COM1 console redirection.

### 4.3.6 CPU Configuration

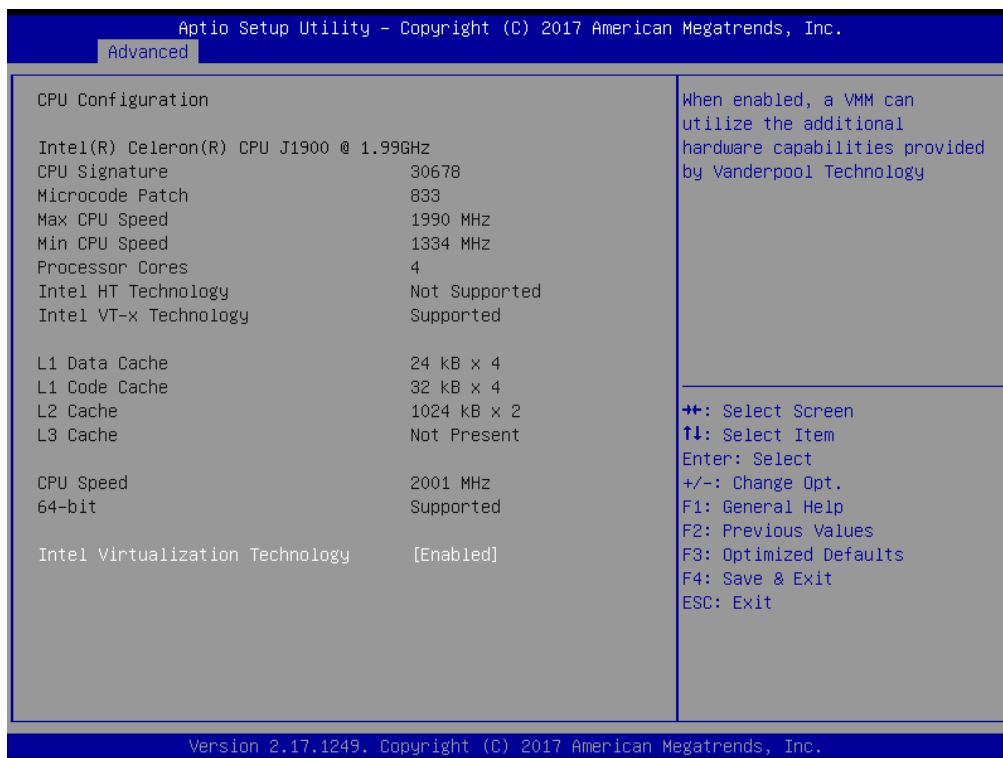

#### ■ Intel Virtualization Technology

Virtualization enhanced by Intel Virtualization Technology will allow a platform to run multiple operating systems and applications in independent partitions. With virtualization, one computer system can function as multiple Virtual systems.

### 4.3.7 SATA Configuration

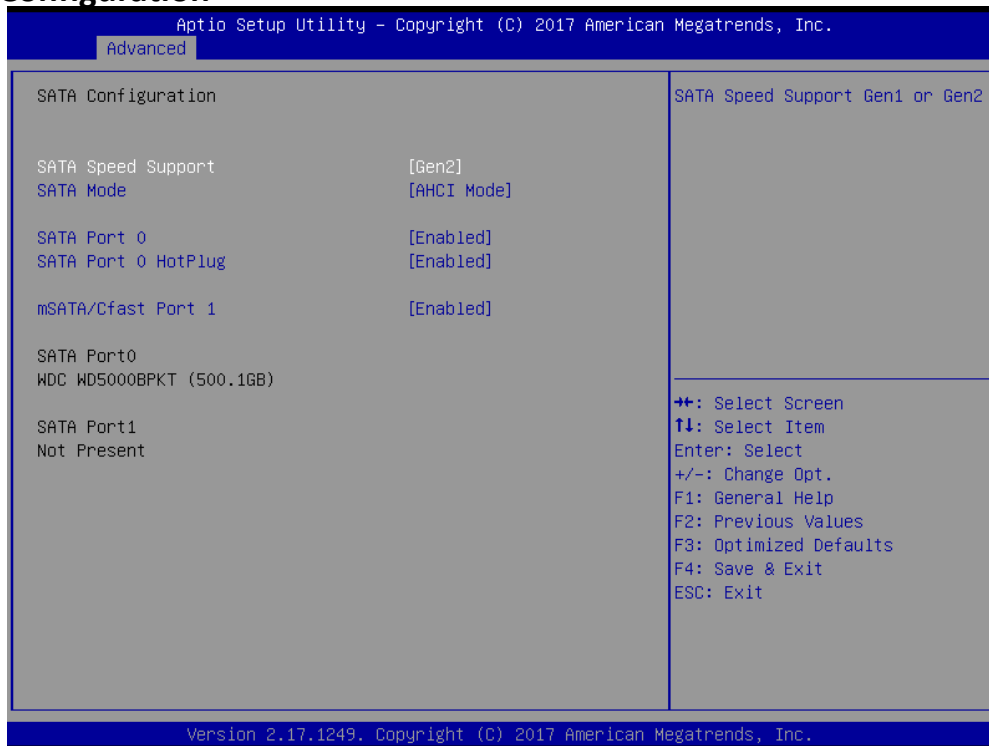

#### ■ SATA Speed Support

Change the SATA Speed. Select <Gen1> or <Gen2> speed.

#### ■ SATA Mode

This item allows you to select IDE or AHCI Mode.

#### ■ SATA Port 0

This item allows you to enable or disable SATA Port 0.

#### ■ SATA Port 0 HotPlug

This item allows you to enable or disable SATA Port 0 hot plug function.

#### ■ SATA Port 1/mSATA/Cfast

This item allows you to enable or disable SATA Port 1/mSATA/Cfast.

### 4.3.8 OS Selection



### 4.3.9 CSM Configuration

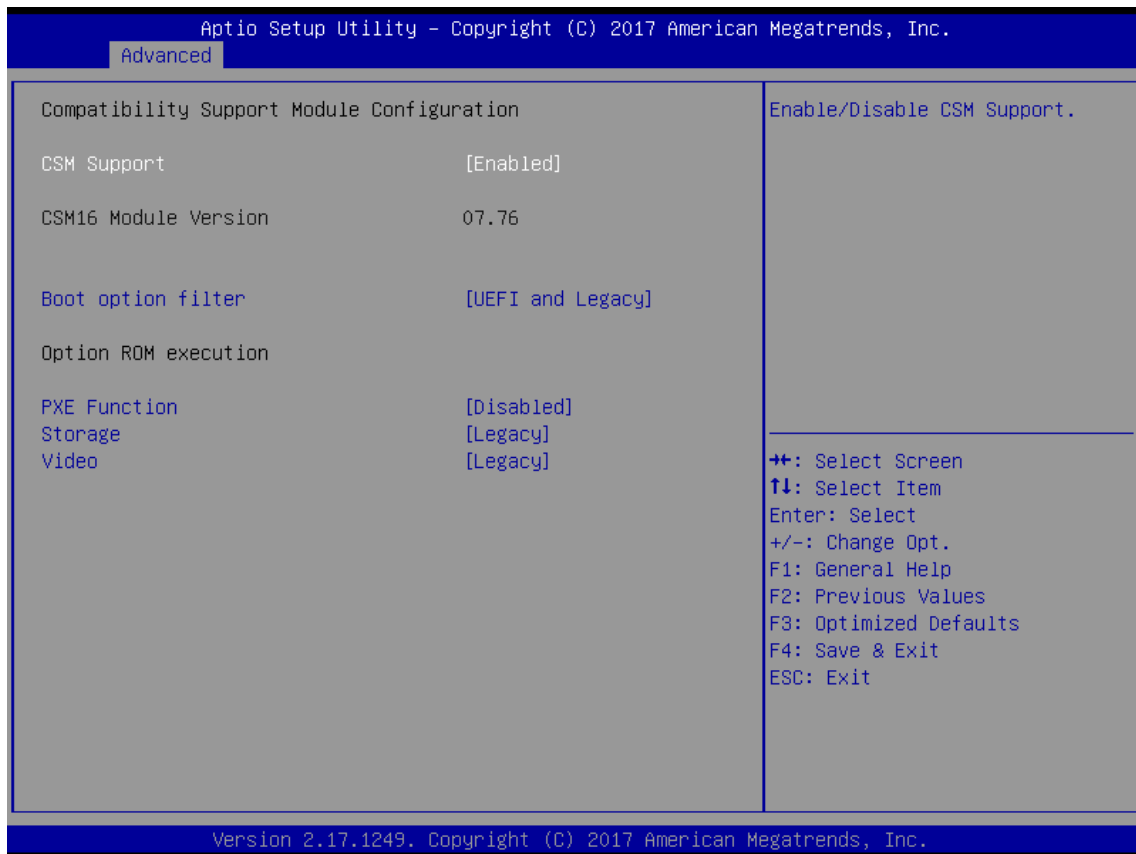

#### ■ CSM Support

Enables or disables UEFI CSM (Compatibility Support Module) to support a legacy PC boot process.

#### ■ Boot option filter

This item allows you to select which type of operating system to boot.

UEFI and Legacy: Allows booting from operating systems that support legacy option ROM or UEFI option ROM.

Legacy only: Allows booting from operating systems that only support legacy option ROM.

UEFI only: Allows booting from operating systems that only support UEFI option ROM.

This item is configurable only when CSM Support is set to Enabled.

#### ■ PXE Function

This item allows you to enable or disable PXE function.

#### ■ Storage

This setting allows you to select whether to enable the UEFI or legacy option ROM for the storage device controller.

Do not launch: Disables option ROM.

UEFI only: Enables UEFI option ROM only.

Legacy only: Enables legacy option ROM only.

#### ■ Video

This item allows you to select whether to enable the UEFI or legacy option ROM for the storage device controller.

Do not launch: Disables option ROM.

UEFI only: Enables UEFI option ROM only.

Legacy only: Enables legacy option ROM only.

### 4.3.10 USB Configuration

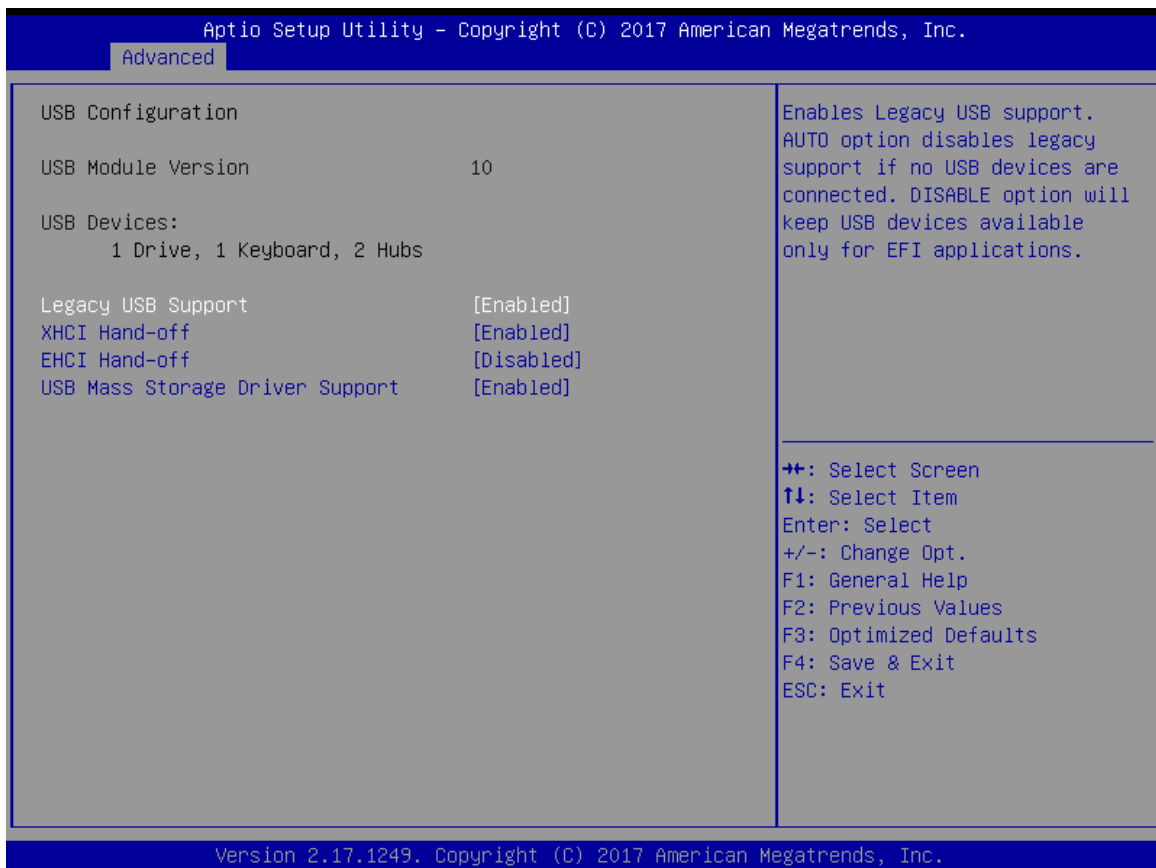

#### ■ Legacy USB Support

Allows USB keyboard/ mouse to be used in MS-DOS.

#### ■ XHCI Hand-off

Determines whether to enable XHCI (USB3.0) Hand-off feature for an operating system without XHCI (USB3.0) Hand-off support.

#### ■ EHCI Hand-off

Determines whether to enable EHCI Hand-off feature for an operating system without EHCI Hand-off support.

#### ■ USB Mass Storage Driver Support

Enables or disables support for USB storage devices.

### 4.3.11 Intel® I210 Gigabit Network Connection- XX:XX:XX:XX:XX:XX

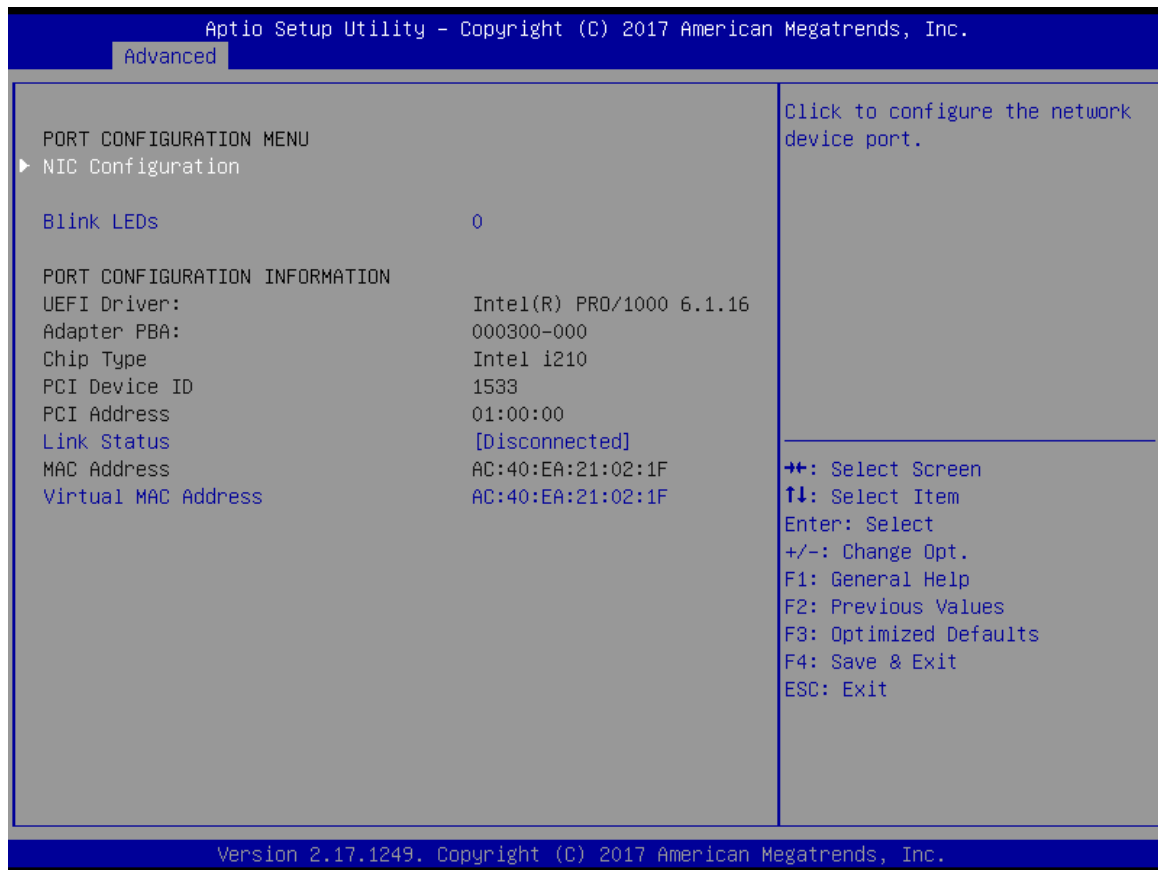

#### ■ NIC Configuration

Press enter to configure the network device port.

##### ● Link Speed

Use this item to specify the port speed used for the selected boot protocol. Select <Auto Negotiated>, <10 Mbps Half>, <10 Mbps Full>, <100Mbps Half> or <100 Mbps Full>.

##### ● Wake On LAN

Enables the server to be powered on using an in-band magic packet.

#### ■ Blink LEDs

Use this item to identify the physical network port by blinking the associated LED.

#### ■ Link Status

Use this item to specify the port speed used for the selected boot protocol. Select <Auto Negotiated>, <10 Mbps Half>, <10 Mbps Full>, <100 Mbps Half> or <100 Mbps Full>.

#### ■ Virtual MAC Address

Displays the programmatically assignable MAC Address.



## 4.4 Chipset

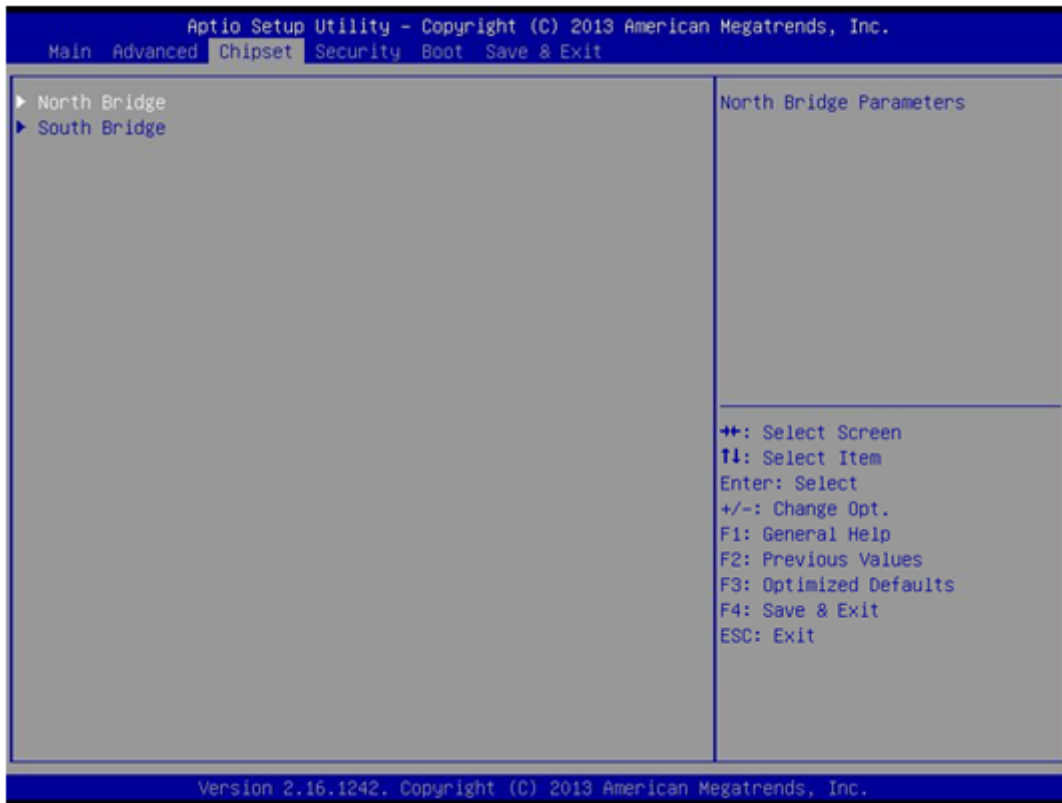

### 4.4.1 North Bridge

This section provides information on the installed memory size and memory/onboard graphics-related configuration options.



## Intel IGD Configuration

This section provides onboard graphics-related configuration options.

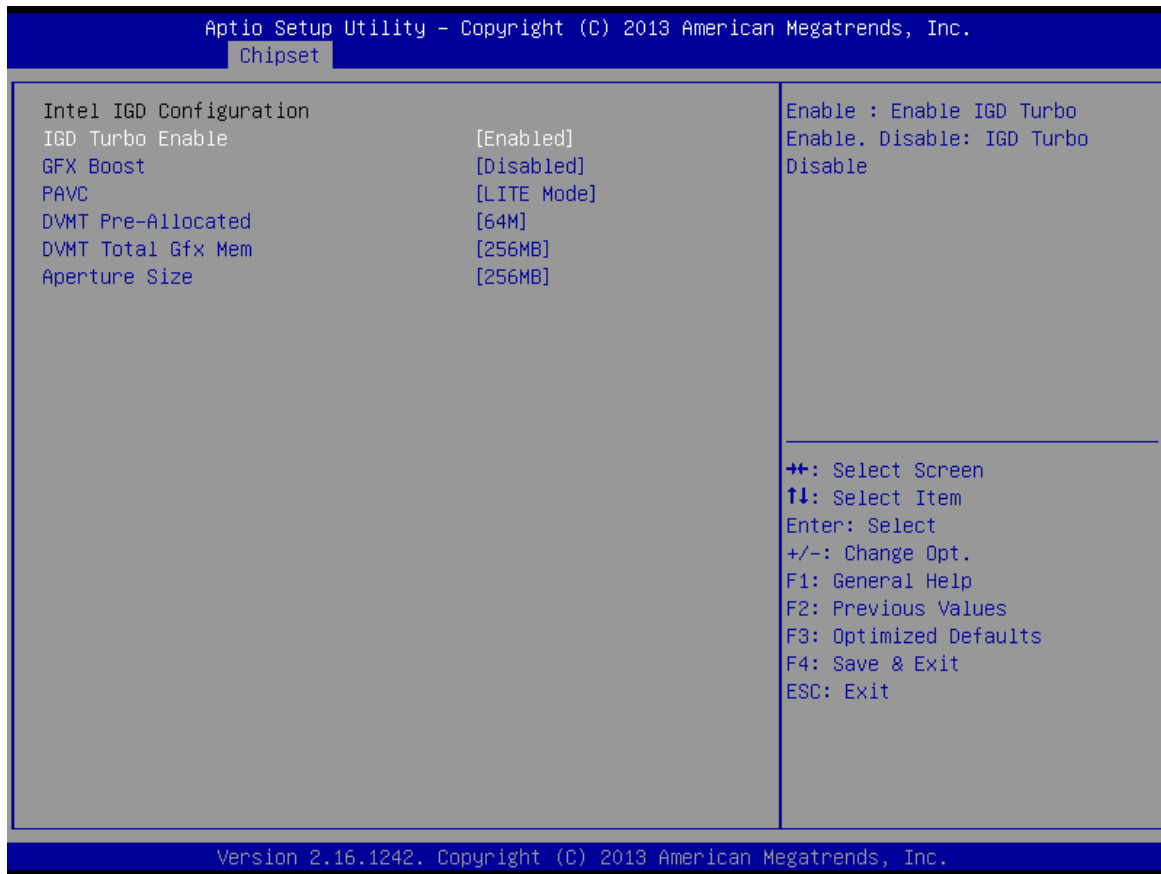

- **IGD Turbo Enable**

This item allows you to enable or disable IGD Turbo.

- **GFX Boost**

This item allows you to enable or disable GFX Boost.

- **PAVC**

This item enables/disables Protected Audio Video Control. Select <Disabled>, <LITE Mode> or <SERPENT Mode>.

- **DVMT Pre-Allocated**

This item selects DVMT 5.0 Pre-Allocated (Fixed) Graphics Memory size used by the Internal Graphics Device. . Select <64M>, <96M>, <128M>, <160M>, <192M>, <224M>, <256M>, <288M>, <320M>, <352M>, <384M>, <416M>, <448M>, <480M> or <512M>.

- **DVMT Total Gfx Mem**

This item selects DVMT5.0 Total Graphic Memory size used by the Internal Graphics Device. Select <128MB>, <256MB> or <Max>.

- **Aperture Size**

This item selects the Aperture Size. Select <128MB>, <256MB> or <512MB>.

## 4.4.2 South Bridge

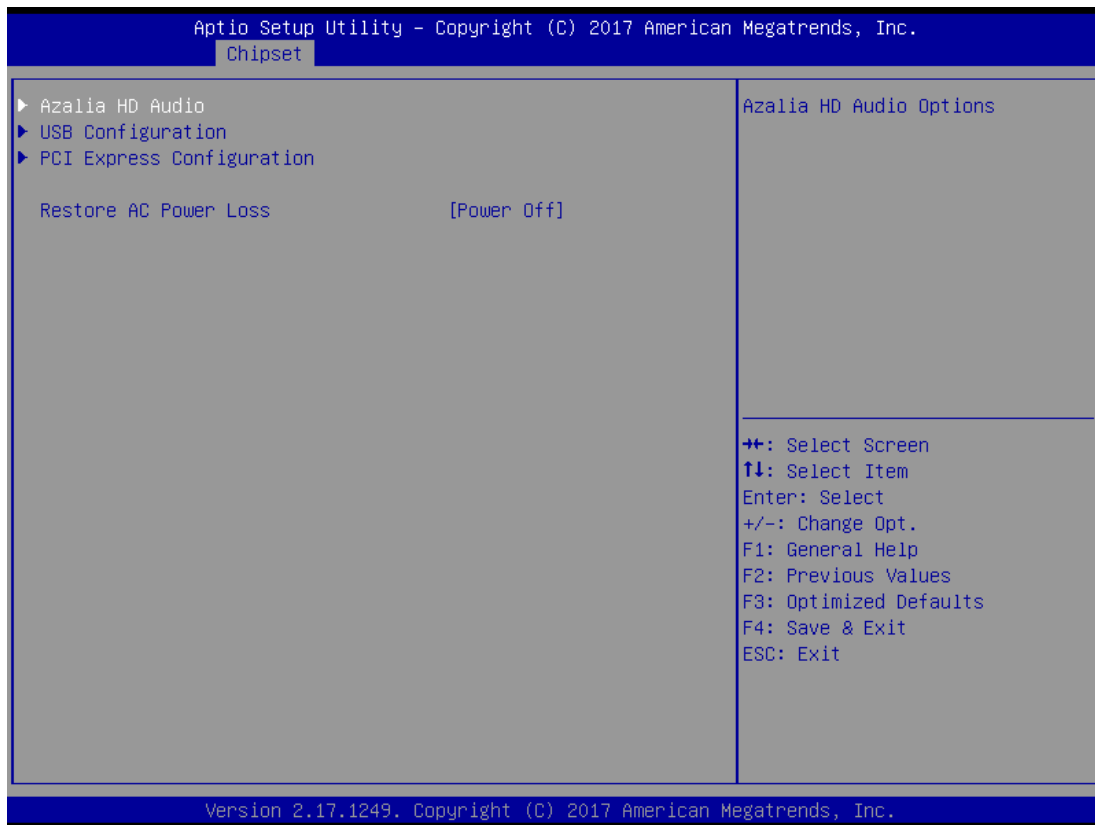

### ■ Azalia HD Audio

Control detection of the Azalia device.

#### ● Audio Controller

Enabled: Azalia will be unconditionally enabled.

Disabled: Azalia will be unconditionally disabled.

### ■ USB Configuration

#### ● XHCI Mode

This item allows you to enable or disable the USB XHCI controller.

#### ● USB 2.0 (EHCI) Support

This item allows you to enable or disable the USB EHCI support.

## ■ PCI Express Configuration

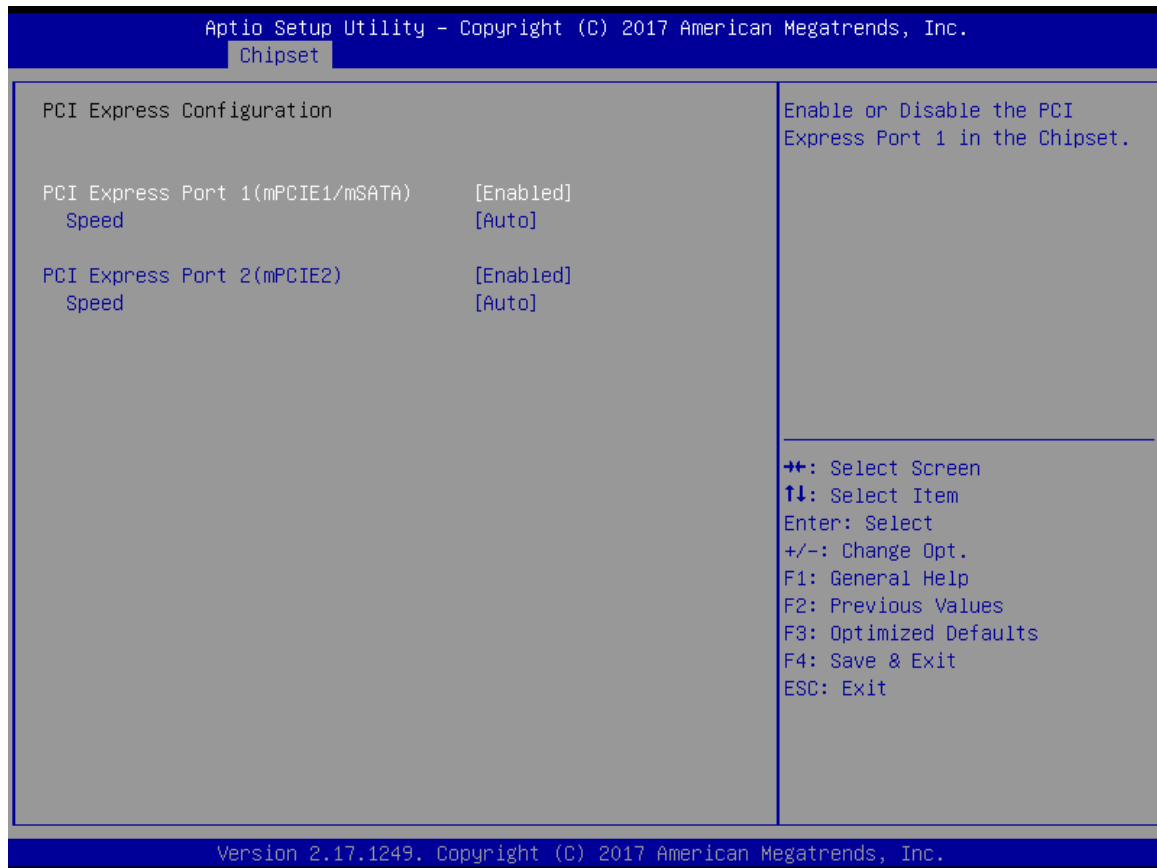

- **PCI Express Port 1 (mPCIIE1/mSATA)**

This item allows you to enable or disable PCI Express Port 1 (Mpcie1/mSATA) in the Chipset.

- **Speed**

Change the PCIe Port Speed. Select <AUTO> ,<Gen 2> or <Gen 1>

- **PCI Express Port 2 (mPCIIE2)**

This item allows you to enable or disable PCI Express Port 2 (mPCIIE2) in the Chipset.

- **Speed**

Change the PCIe Port Speed. Select <AUTO> ,<Gen 2> or <Gen 1>

## ■ Restore AC Power Loss

This item specifies whether your system will reboot after a power failure or interrupt occurs.

Available settings are:

Power Off: Leave the computer in the power off state.

Power On: Leave the computer in the power on state.

Last State: Restore the system to the previous status before power failure or interrupt occurred.

## 4.5 Security

Security menu allow you to change administrator password and user password settings.

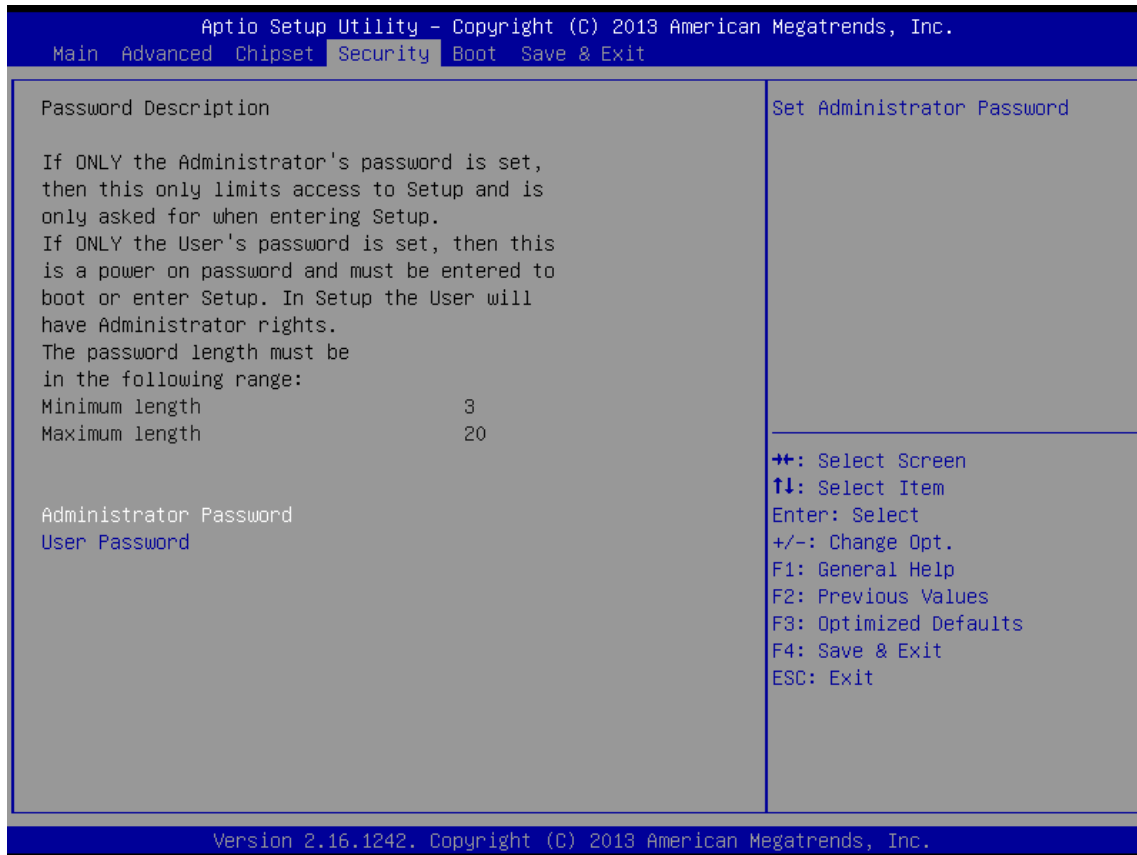

### 4.5.1 Administrator Password

This item allows you to set Administrator Password.

### 4.5.2 User Password

This item allows you to set User Password.

## 4.6 Boot

This menu allows you to setup the system boot options.

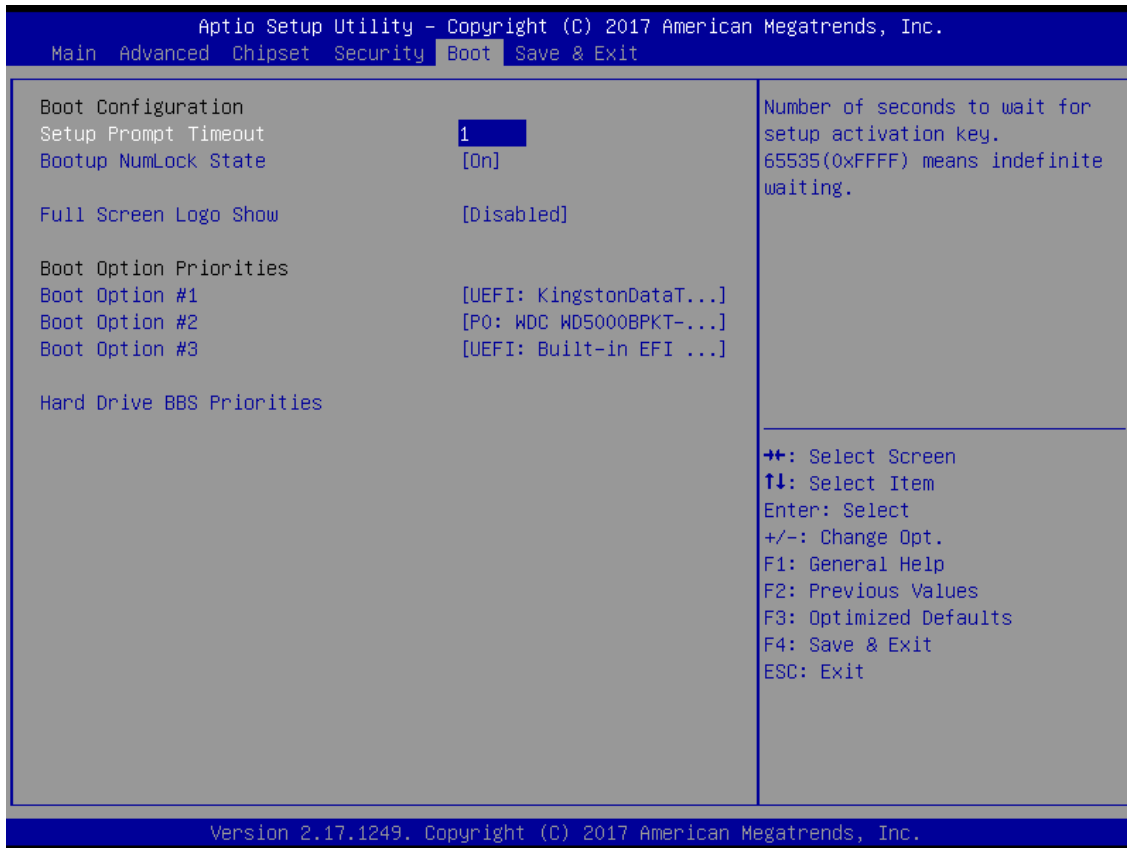

### 4.6.1 Setup Prompt Timeout

This item sets number of seconds to wait for setup activation key.

### 4.6.2 Bootup NumLock State

This item selects the keyboard NumLock state. Select <On> or <Off>.

### 4.6.3 Full Screen Logo Show

This item allows you to enable or disable Full Screen Logo Show function.

### 4.6.4 Boot Option Priorities

The items specify the boot device priority sequence from the available devices. The number of device items that appears on the screen depends on the number of devices installed in the system.

## 4.7 Save & Exit

This setting allows you to configure the boot settings.

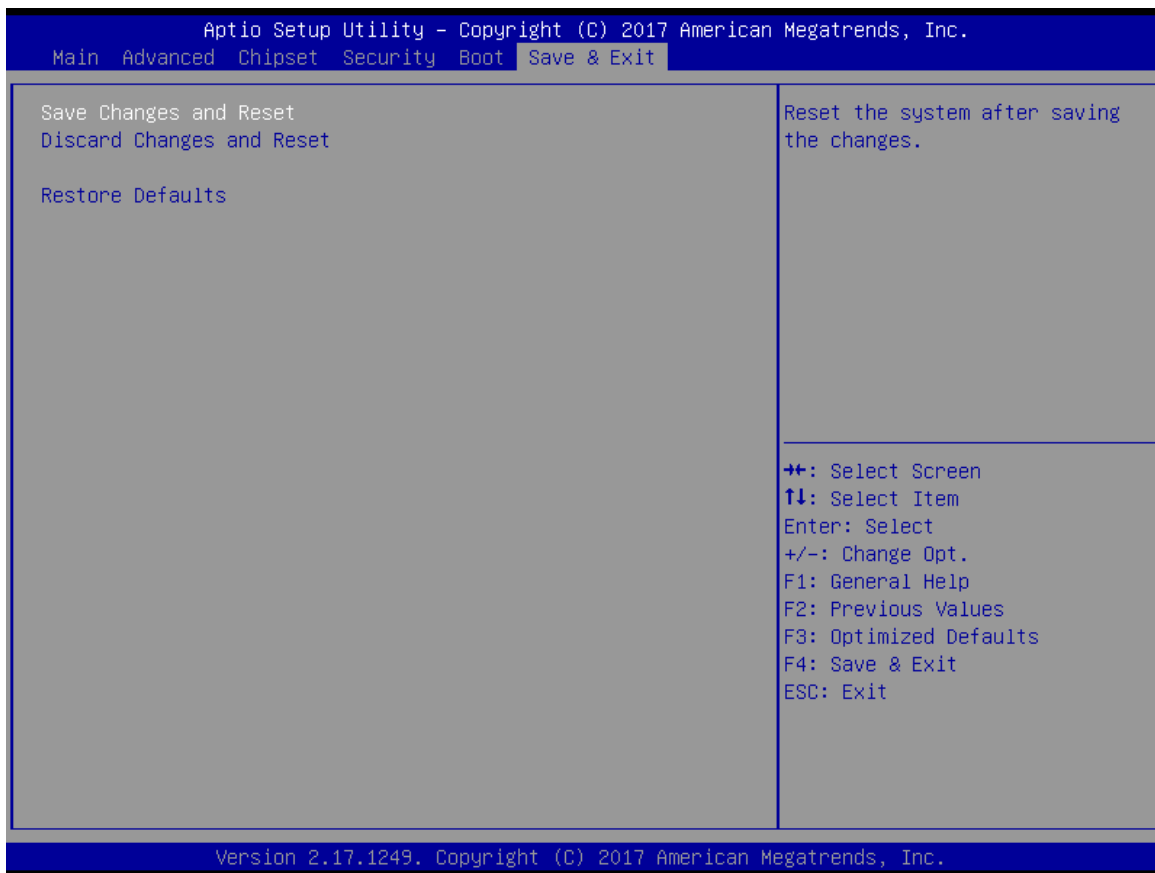

### 4.7.1 Save Changes and Reset

This item allows you reset the system after saving the changes.

### 4.7.2 Discard Changes and Reset

Select this option to quit Setup without making any permanent changes to the system configuration.

### 4.7.3 Restore Defaults

This selection allows you to reload the BIOS when problem occurs during system booting sequence. These configurations are factory settings optimized for this system.

# Appendix

## WDT & GPIO

This appendix provides the sample codes of WDT (Watch Dog Timer) and GPIO (General Purpose Input/ Output).



## WDT Sample Code

### Sample Code:

Set watchdog timer to 30 seconds

```
AddrPort =0x4e;
DataPort=0x4f;
SIO_UNLOCK_VALUE=0x87;
SIO_LOCK_VALUE=0xaa;
WATCHDOG_LDN=0x07;
WDT_UNIT=0x60; // 0x60=sec, 0x68=min, 0x40=disable watchdog timer
WDT_TIMER= 30;

// Set watchdog timer to 30 seconds
// enable config mode, switch WDT configuration
WriteByte(AddrPort, SIO_UNLOCK_VALUE);
usleep(4000); //delay
WriteByte(AddrPort, SIO_UNLOCK_VALUE);
WriteByte(AddrPort, 0x07);
WriteByte(DataPort, WATCHDOG_LDN);

// activate wdt
WriteByte(AddrPort, 0x30);
data=ReadByte(DataPort);
data=data|0x01;
WriteByte(DataPort, data);

// set timer value
WriteByte(AddrPort, 0xf6);
WriteByte(DataPort, WDT_TIMER);

// set unit
WriteByte(AddrPort, 0xf5);
WriteByte(DataPort, WDT_UNIT);

// enable reset
WriteByte(AddrPort, 0xfa);
data=ReadByte(DataPort);
data=data|0x01;
WriteByte(DataPort, data);

// close config mode
WriteByte(AddrPort, SIO_LOCK_VALUE);
```

## GPIO Sample Code

### ● GPI 0 ~ GPI 3

	GPI 0	GPI 1	GPI 2	GPI 3
IO Address	0xA03	0xA03	0xA03	0xA03
Bit	4	5	6	7
Sample code	<b>#1</b>			

### ● GPO 0 ~ GPO 3

	GPO 0	GPO 1	GPO 2	GPO 3
IO Address	0xA02	0xA02	0xA02	0xA02
Bit	0	1	2	3
Sample code	<b>#2</b>			

#### Sample Code:

```
GPI_REG = 0xA03;
GPO_REG = 0xA02;
GPO_0 = 0x01; //bit0 is 1
```

```
#1 : Get GPI 0 status
// Get GPI 0 Pin Status
data=ReadByte(GPI_REG); // data bit4 is GPI 0 status
```

```
#2 : Set GPO 0 status to high
// Set GPO 0 Pin to High
data=ReadByte(GPO_REG);
data |= GPO_0;
WriteByte(GPO_REG, data); //data bit0 set GPO 0 status to high
```

## ● GPI 4 ~ GPI 7

	GPI 4	GPI 5	GPI 6	GPI 7
IO Address	0xA06	0xA06	0xA06	0xA06
Bit	0	1	2	3
Sample code	<b>#3</b>			

## ● GPO 4 ~ GPO 7

	GPO 4	GPO 5	GPO 6	GPO 7
IO Address	0xA06	0xA07	#5	0xA04
Bit	4	7	0	7
Sample code	<b>#4</b>		#5	

**Sample Code:**

```
GPI_REG = 0xA06;
GPO_REG = 0xA06;
GPO_4 = 0x10; //bit4 is 1
```

```
#3 : Get GPI 4 status
// Get GPI 4 Pin Status
data=ReadByte(GPI_REG); // data bit0 is GPI 4 status
```

```
#4 : Set GPO 4 status to high
// Set GPO 4 Pin to High
data=ReadByte(GPO_REG);
data |= GPO_4;
WriteByte(GPO_REG, data); //data bit4 set GPO 4 status to high
```

#5 : Set GPO 6 status to high

Ps. GPO 6 must be accessed by gpio configuration (IO address is protected)

```
AddrPort =0x4e;
DataPort=0x4f;
SIO_UNLOCK_VALUE=0x87;
SIO_LOCK_VALUE=0xaa;
SIO_LDN_GPIO =0x06;
GPO_REG=0xd1;
GPO_6 =0x01; //bit0 is 1
```

```
// enable config mode, switch GPIO configuration
WriteByte(AddrPort, SIO_UNLOCK_VALUE);
usleep(4000); //delay
WriteByte(AddrPort, SIO_UNLOCK_VALUE);
WriteByte(AddrPort, 0x07);
WriteByte(DataPort, SIO_LDN_GPIO);
```

```
// Set GPO 6 Pin to high
WriteByte(AddrPort, GPO_REG);
data=ReadByte(DataPort);
data=data| GPO_6;
WriteByte(DataPort, data); // data bit0 set GPO 6 status to high
```

```
// close config mode
WriteByte(AddrPort, SIO_LOCK_VALUE);
```

