

# USER'S MANUAL

## PC400 Series PC Module



# Table of Contents

<b>Prefaces .....</b>	<b>04</b>
Revision .....	04
Disclaimer .....	04
Copyright Notice .....	04
Trademarks Acknowledgment .....	04
Environmental Protection Announcement .....	04
Safety Precautions .....	05
Technical Support and Assistance .....	06
Conventions Used in this Manual .....	06
Package Contents .....	07
Ordering Information .....	07
Optional Accessory .....	07
<b>Chapter 1 Product Introductions .....</b>	<b>08</b>
1.1 Overview .....	09
1.1.1 Key Feature .....	09
1.2 Hardware Specification .....	10
1.3 System I/O .....	11
1.3.1 PC400 .....	11
1.3.2 PC410 .....	13
1.4 Mechanical Dimension .....	16
1.4.1 PC400 .....	16
1.4.2 PC410 .....	17
<b>Chapter 2 Switches and Connectors .....</b>	<b>18</b>
2.1 Switch and Connector Locations .....	19
2.1.1 Top View .....	19
2.1.2 Bottom View .....	20
2.2 Connector / Switch Definition .....	21
2.3 Switch Definitions .....	22
2.4 Connector Definitions .....	24
<b>Chapter 3 System Setup .....</b>	<b>33</b>
3.1 Set torque force to 3.5 kgf-cm to execute all the screwing and unscrewing. ....	34
3.2 Installing SODIMM .....	34
3.3 Installing mini PCIe card / mSATA .....	35
3.4 Installing HDD on removable SATA HDD bay .....	36
3.5 Installing CFast card .....	38
3.6 Installing SIM card .....	39
3.7 Removing chassis top cover .....	41
3.8 Installing antenna .....	42
3.9 Assembling chassis top cover .....	44
3.10 Connecting PC module with VIO display module .....	46

<b>Chapter 4</b>	<b>BIOS Setup .....</b>	<b>47</b>
4.1	BIOS Introduction .....	48
4.2	Main Setup .....	49
4.3	Advanced Setup .....	50
	4.3.1 CPU Configuration .....	51
	4.3.2 PCH-FW Configuration .....	52
	4.3.3 SATA and RST Configuration .....	52
	4.3.4 RST (UEFI RAID) Configuration .....	53
	4.3.5 Trusted Computing .....	55
	4.3.6 ACPI Settings .....	55
	4.3.7 Super IO Configuration .....	56
	4.3.8 Hardware Monitor .....	59
	4.3.9 Serial Port Console Redirection .....	60
	4.3.10 Stack Configuration .....	60
	4.3.11 CSM Configuration .....	61
	4.3.12 USB Configuration .....	62
4.4	Chipset .....	63
	4.4.1 System Agent (SA) Configuration .....	63
	4.4.2 PCH-IO Configuration .....	65
4.5	Security .....	68
4.6	Boot .....	69
4.7	Save & Exit .....	70
<b>Appendix</b>	<b>WDT &amp; GPIO .....</b>	<b>71</b>
	WDT Sample Code .....	72
	GPIO Sample Code .....	73

## Prefaces

### Revision

Revision	Description	Date
1.0	Manual Released	2019/09/18

### Disclaimer

All specifications and information in this User's Manual are believed to be accurate and up to date. C&T Solution Inc. does not guarantee that the contents herein are complete, true, accurate or non-misleading. The information in this document is subject to change without notice and does not represent a commitment on the part of C&T Solution Inc.

C&T Solution Inc. disclaims all warranties, express or implied, including, without limitation, those of merchantability, fitness for a particular purpose with respect to contents of this User's Manual. Users must take full responsibility for the application of the product.

### Copyright Notice

All rights reserved. No part of this manual may be reproduced or transmitted in any form or by any means, electronic or mechanical, including photocopying, recording, or information storage and retrieval systems, without the prior written permission of C&T Solution Inc. Copyright © C&T Solution Inc.

### Trademarks Acknowledgment

Intel®, Celeron® and Pentium® are trademarks of Intel Corporation.

Windows® is registered trademark of Microsoft Corporation.

AMI is trademark of American Megatrend Inc.

IBM, XT, AT, PS/2 and Personal System/2 are trademarks of International Business Machines Corporation

All other products and trademarks mentioned in this manual are trademarks of their respective owners.

### Environmental Protection Announcement

Do not dispose this electronic device into the trash while discarding. Please recycle to minimize pollution and ensure environment protection.

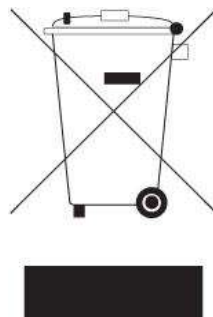

## Safety Precautions

Before installing and using the equipment, please read the following precautions:

- Put this equipment on a reliable surface during installation. Dropping it or letting it fall could cause damage.
- The power outlet shall be installed near the equipment and shall be easily accessible.
- Turn off the system power and disconnect the power cord from its source before making any installation. Be sure both the system and the external devices are turned OFF. Sudden surge
- of power could ruin sensitive components. Make sure the equipment is properly grounded.
- When the power is connected, never open the equipment. The equipment should be opened only by qualified service personnel.
- Make sure the voltage of the power source is correct before connecting the equipment to the power outlet.
- Disconnect this equipment from the power before cleaning. Use a damp cloth. Do not use liquid or spray detergents for cleaning.
- Avoid the dusty, humidity and temperature extremes.
- Do not place heavy objects on the equipment.
- If the equipment is not used for long time, disconnect it from the power to avoid being damaged by transient over-voltage.
- The storage temperature shall be above  $-40^{\circ}\text{C}$  and below  $85^{\circ}\text{C}$ .
- The computer is provided with a battery-powered real-time clock circuit. There is a danger of explosion if incorrectly replaced. Replace only with the same or equivalent type recommended by the manufacturer.
- If one of the following situation arises, get the equipment checked by service personnel:
  - The power cord or plug is damaged.
  - Liquid has penetrated into the equipment.
  - The equipment has been exposed to moisture.
  - The equipment does not work well or it cannot work according the user's manual.
  - The equipment has been dropped and damaged.
  - The equipment has obvious signs of breakage.

## Technical Support and Assistance

1. Visit the C&T Solution Inc website at <https://www.candtsolution.com> where you can find the latest information about the product.
2. Contact your distributor, our technical support team or sales representative for technical support if you need additional assistance. Please have following information ready before you call:
  - Model name and serial number
  - Description of your peripheral attachments
  - Description of your software (operating system, version, application software, etc.)
  - A complete description of the problem
  - The exact wording of any error messages

## Conventions Used in this Manual

**WARNING**

This indication alerts operators to an operation that, if not strictly observed, may result in severe injury.

**CAUTION**

This indication alerts operators to an operation that, if not strictly observed, may result in safety hazards to personnel or damage to equipment.

**NOTE**

This indication provides additional information to complete a task easily.

## Package Contents

Before installation, please ensure all the items listed in the following table are included in the package.

Item	Description	Q'ty
1	P4300 Series PC Module	1
2	Utility DVD Driver	1
3	Screw Pack	1

## Ordering Information

Model No.	Product Description
PC400-7300U	PC Module for Industrial Display System with Intel® Core™ i5-7300U Processor
PC400-7100U	PC Module for Industrial Display System with Intel® Core™ i3-7100U Processor
PC410-7300U	PC Module for Industrial Display System with Intel® Core™ i5-7300U Processor, 1x Universal I/O Bracket
PC410-7100U	PC Module for Industrial Display System with Intel® Core™ i3-7100U Processor, 1x Universal I/O Bracket

## Optional Accessories

Model No.	Product Description
1-E09A06007	Adapter AC/DC 12V 5A 60W with 3pin Terminal Block Plug 5.0mm Pitch
SFICBL022	Power Cord, 3-pin US Type, 180cm
1-TPCD00002	Power Cord, European Type, 180cm
1-TPCD00001	Power Cord, 3-pin UK Type, 180cm

## Chapter 1

# Product Introductions



## 1.1 Overview

The PC400 series PC module is based on 7<sup>th</sup> Gen. Intel® Core™ i5-7300U (up to 3.5GHz) / i3-7100U (2.4GHz) Dual Core processor. It supports Multi-Mode Display Module (MDM) technology which makes it more flexible in system maintaining and upgrading. It also offers modularize expansion I/O, rich connectivity interfaces, wide range (9~50VDC) DC power input, and high reliability even operating in temperature extremes (-40~+70 °C).

Featuring with completely cable-less designed and high functional, PC400 series are ruggedized display systems that can operate in harsh environments and easy to install and maintain. A build in over voltage protection (OVP), over current protection (OCP), reserve voltage protection, and wide range DC power input makes PC400 series are safety system for all industrial applications.



### 1.1.1 Key Features

- Intel® 7<sup>th</sup> Gen (Kaby Lake-U) Processor Core™ i5-7300U up to 3.5GHz / Core™ i3-7100U, 2.4 GHz
- 1x 260-pin DDR4 SODIMM. max up to 16GB
- 1x 2.5" SATA HDD bay support RAID 0, 1
- 1x mSATA (shared by 1x Mini PCIe), 1x CFast (shared by 1x mSATA), 2x SIM socket
- 2x full-size mini PCIe for communication or expansion modules
- 2x LAN, 1x VGA, 1x DisplayPort, 1x Dual Channel 24 bit LVDS
- 4x RS-232/422/485, 4x USB 3.0, Audio
- 8x DI + 8x DO with isolation
- 1x Universal I/O Bracket for Expansion (PC410 Only)
- 9 to 50VDC wide range power input
- -40°C to 70°C extended operating temperature

## 1.2 Hardware Specification

### Processor System

- 7<sup>th</sup> Gen Intel® Core™ i5 / i3 Processor with AMI 128Mbit SPI BIOS
  - Intel® Core™ i5-7300U Processor, Dual Core, 3MB Cache, up to 3.5 GHz
  - Intel® Core™ i3-7100U Processor, Dual Core, 3MB Cache, 2.4 GHz

### Memory

- 1x 260-Pin DDR4 1866/2133MHz SODIMM. Max. up to 16GB

### Display

#### Triple Display

- 1x VGA
- 1x DisplayPort
- 1x Dual Channel 24 bit LVDS

### Expansion

- 2x Full-size Mini PCIe Socket for Wi-Fi / GSM / Expansion Module
- 1x Universal I/O Bracket ([PC410 only](#))

### Ethernet

- 1x Intel® i219LM GbE LAN Port, Support Wake-on-LAN and PXE
- 1x Intel® I210-AT GbE LAN Port, Support Wake-on-LAN and PXE

### Audio

- Codec: Realtek ALC888S
- 1x Mic-in and 1x Line-out

### Watchdog Timer

- Software Programmable Supports 1~255 sec. System Reset

### Storage

- 1x Removable 2.5" SATA HDD Bay, support RAID 0, 1
- 1x mSATA (shared by 1x Mini-PCIe)
- 1x Cfast (shared by 1x mSATA)
- 2x External SIM Card Socket

### I/O Ports

- 4x USB 3.0 Port
- 8x Isolated DI and 8x Isolated DO Port
- 4x External DB9 for COM1~4, Support RS232/422/485 with Auto Flow Control
- 2x Internal COM5~6, Support RS232/422/485 with Auto Flow Control ([PC410 only](#))
- 3x Antenna Hole ([PC400 only](#))
- 4x Antenna Hole ([PC410 only](#))
- 1x AT/ATX Switch
- 1x Remote Power on/off Connector

### Digital Input & Output

- 8x Digital Input (Source Type)
  - Input Voltage (Dry Contact):
    - Logic 0: Close to GND
    - Logic 1: Open
  - Input Voltage:
    - Logic 0: 3V max.
    - Logic 1: 5V min. (DI to COM-)
- 8x Digital Output
  - Supply Voltage: 5~30VDC
  - Sink Current: 200 mA Max. Per Channel

### Power

- Support AT, ATX Mode
- 1x 3-pin Terminal Block Connector with Power Input 9~48VDC
- Power Ignition Sensing
- 1x Optional AC/DC 12V/5A, 60W Power Adapter

### Environment

- Operating Temperature: Ambient with Air Flow: -40°C to 70°C (with Industrial Grade Peripherals)
- Storage Temperature: -40°C to 85°C
- Relative humidity: 10%~95% (non-condensing)

### Physical

- **PC400 Series**
  - Dimension (WxDxH, mm): 246 x 220 x 42mm
  - Weight: 1.57 kg
- **PC410 Series**
  - Dimension (WxDxH, mm): 246 x 220 x 64mm
  - Weight: 1.86 kg
- Construction: Extruded Aluminum with Heavy Duty Metal
- Mounting: VESA Mounting Holes 75 x 75mm, 100 x 100mm

### Operating System

- Windows 10
- Linux kernel 4.X

### Certifications

- CE
- FCC Class A

## 1.3 System I/O

### 1.3.1 PC400

#### Front Panel

##### Removable HDD Bay

Used to insert a 2.5" HDD device

##### Antenna hole

Used to connect an antenna for optional Mini-PCIe WiFi module

##### SIM Card Socket

Used to insert SIM card

##### CFast Socket

Used to insert CFast card

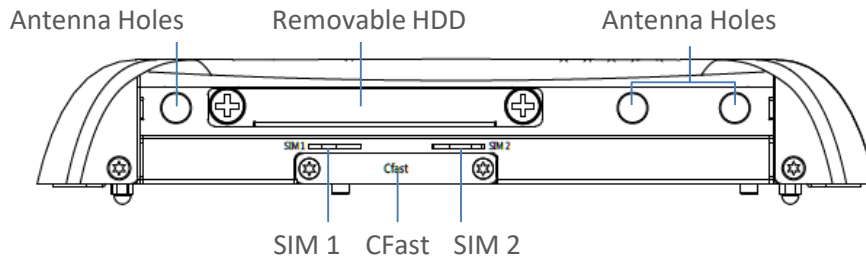

#### Rear Panel

##### DC IN

Used to plug a DC power input with terminal block

##### VGA

Used to connect an analog VGA monitor

##### DisplayPort

Used to connect a DisplayPort monitor

##### USB 3.0 port

Used to connect USB 3.0/2.0/1.1 device

##### LAN port

Used to connect the system to a local area network

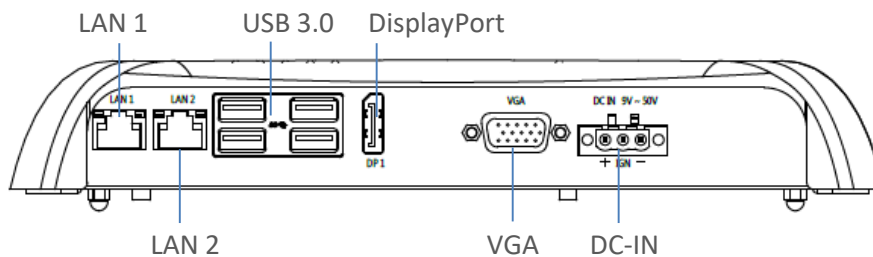

#### Side (Right)

##### COM port

COM3~4 support RS232/422/485 serial device

##### PC/CAR mode select switch

Used to select PC or CAR power mode

##### DELAY TIME switch

Used to select Car power turn off delay-time

##### AT/ATX mode select switch

Used to select AT or ATX power mode

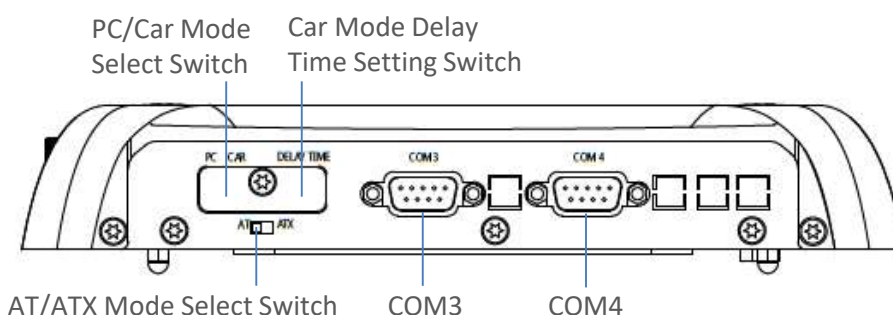

## Side (Left)

### ATX power on/off switch

Press to power-on or power-off the system

### Power LED

Indicates the power status of the system

### HDD LED

Indicates the status of the hard drive

### Reset switch

Press to reset the system

### Digital I/O Terminal Block

The Digital I/O terminal block supports 8 digital input and 8 digital output

### Line-out

Used to connect a speaker

### Mic-in

Used to connect a microphone

### Remote Power on/off Terminal Block

Used to plug a remote power on/off terminal block

### COM port

COM1 ~ COM2 support RS232/422/485 serial device

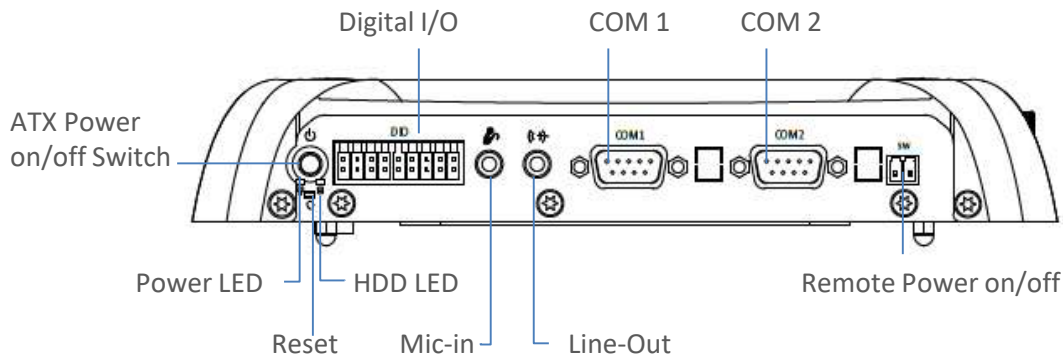

## Top

### VESA Mounting Hole

These are mounting holes for VESA mount (75x75mm and 100x100mm)

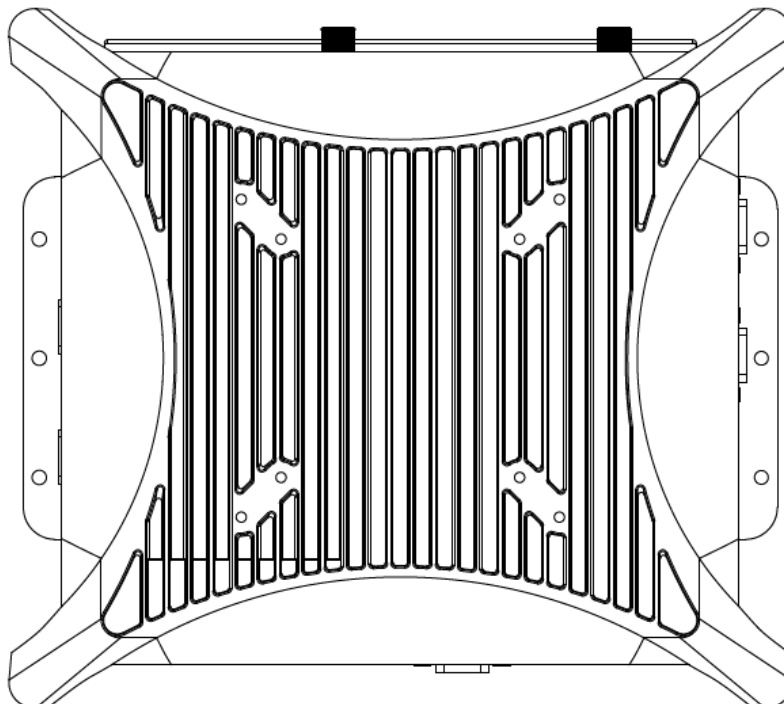

## 1.3.2 PC410

### Front Panel

#### Removable HDD Bay

Used to insert a 2.5" HDD device

#### Antenna hole

Used to connect an antenna for optional Mini-PCIe WiFi module

#### SIM Card Socket

Used to insert SIM card

#### CFast Socket

Used to insert CFast card

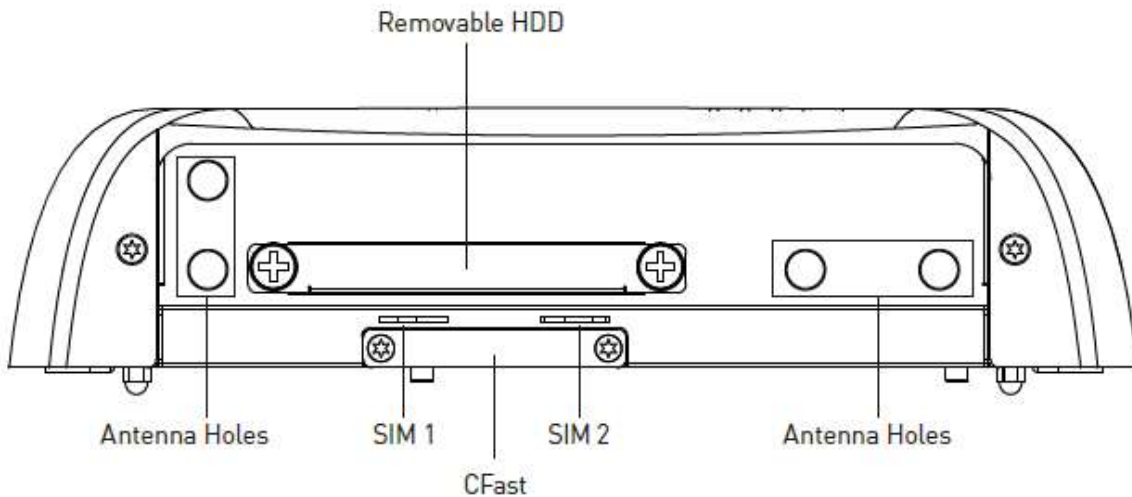

### Rear Panel

#### DC IN

Used to plug a DC power input with terminal block

#### VGA

Used to connect an analog VGA monitor

#### DisplayPort

Used to connect a DisplayPort monitor

#### USB 3.0 port

Used to connect USB 3.0/2.0/1.1 device

#### LAN port

Used to connect the system to a local area network

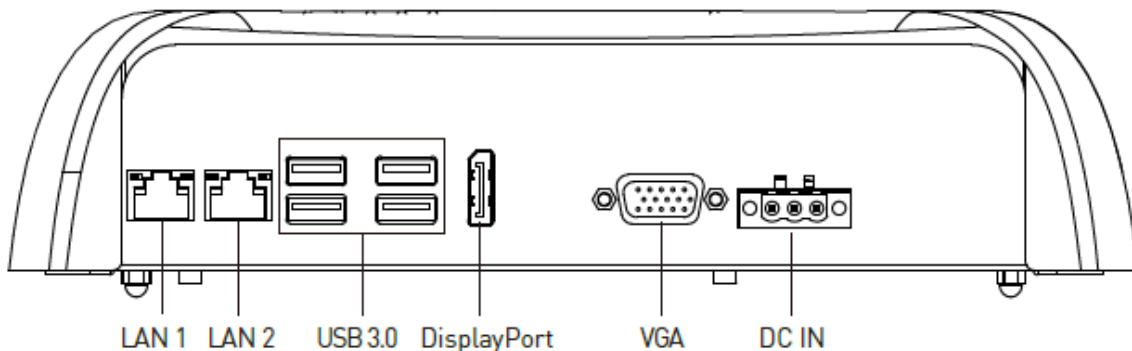

**Side (Right)**

**COM port**

COM3~4 support RS232/422/485 serial device

**PC/CAR mode select switch**

Used to select PC or CAR power mode

**DELAY TIME switch**

Used to select Car power turn off delay-time

**AT/ATX mode select switch**

Used to select AT or ATX power mode

**Universal I/O Bracket**

Used to customized I/O output

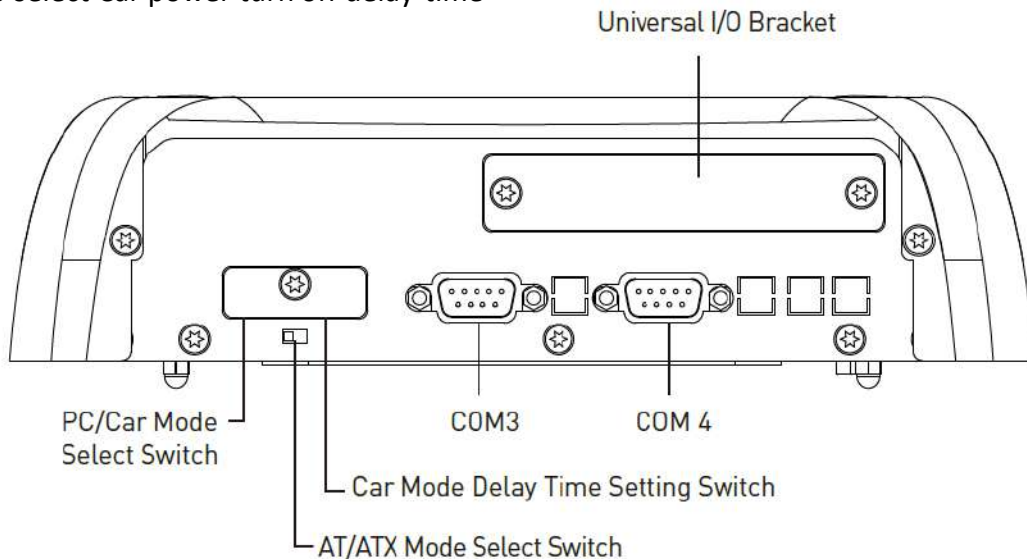

**Side (Left)**

**ATX power on/off switch**

Press to power-on or power-off the system

**Power LED**

Indicates the power status of the system

**HDD LED**

Indicates the status of the hard drive

**Reset switch**

Press to reset the system

**Digital I/O Terminal Block**

The Digital I/O terminal block supports 8 digital input and 8 digital output

**Line-out**

Used to connect a speaker

**Mic-in**

Used to connect a microphone

**Remote Power on/off Terminal Block**

Used to plug a remote power on/off terminal block

**COM port**

COM1 ~ COM2 support RS232/422/485 serial device

**Universal I/O Bracket**

Used to customized I/O output

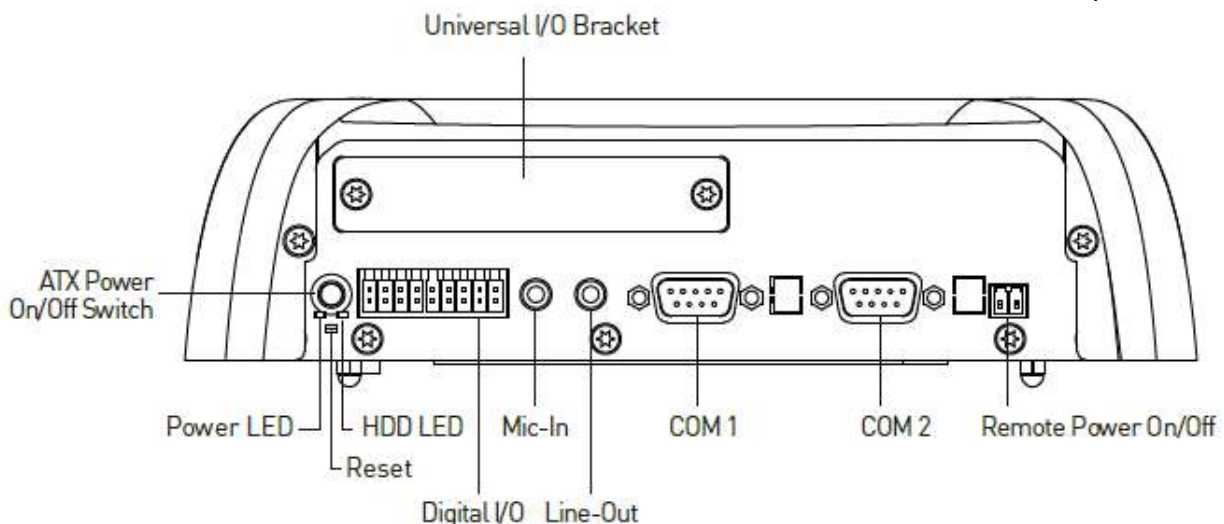

**Top****VESA Mounting Hole**

These are mounting holes for VESA mount (75x75mm and 100x100mm)

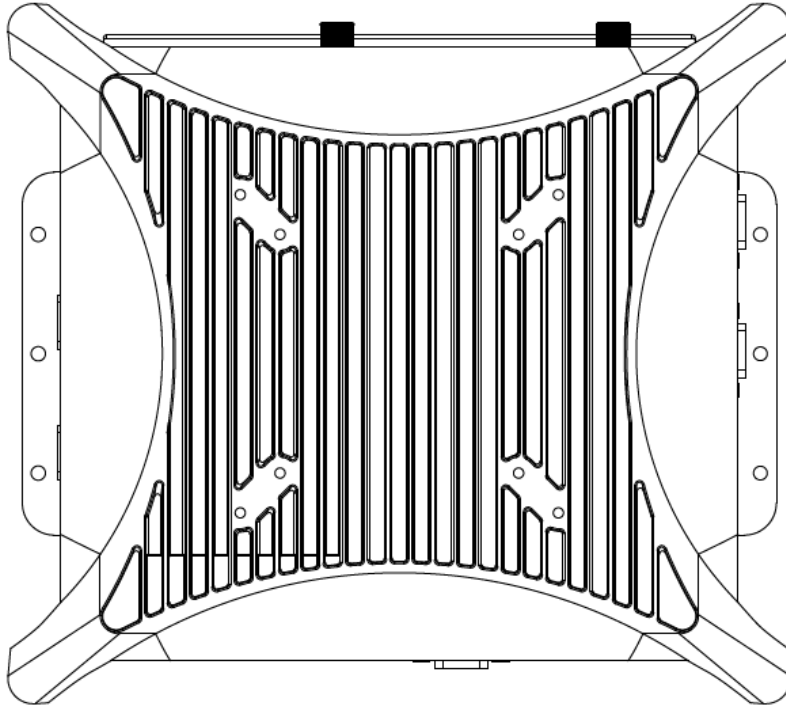

# 1.4 Mechanical Dimensions

## 1.4.1 PC400

Unit: mm

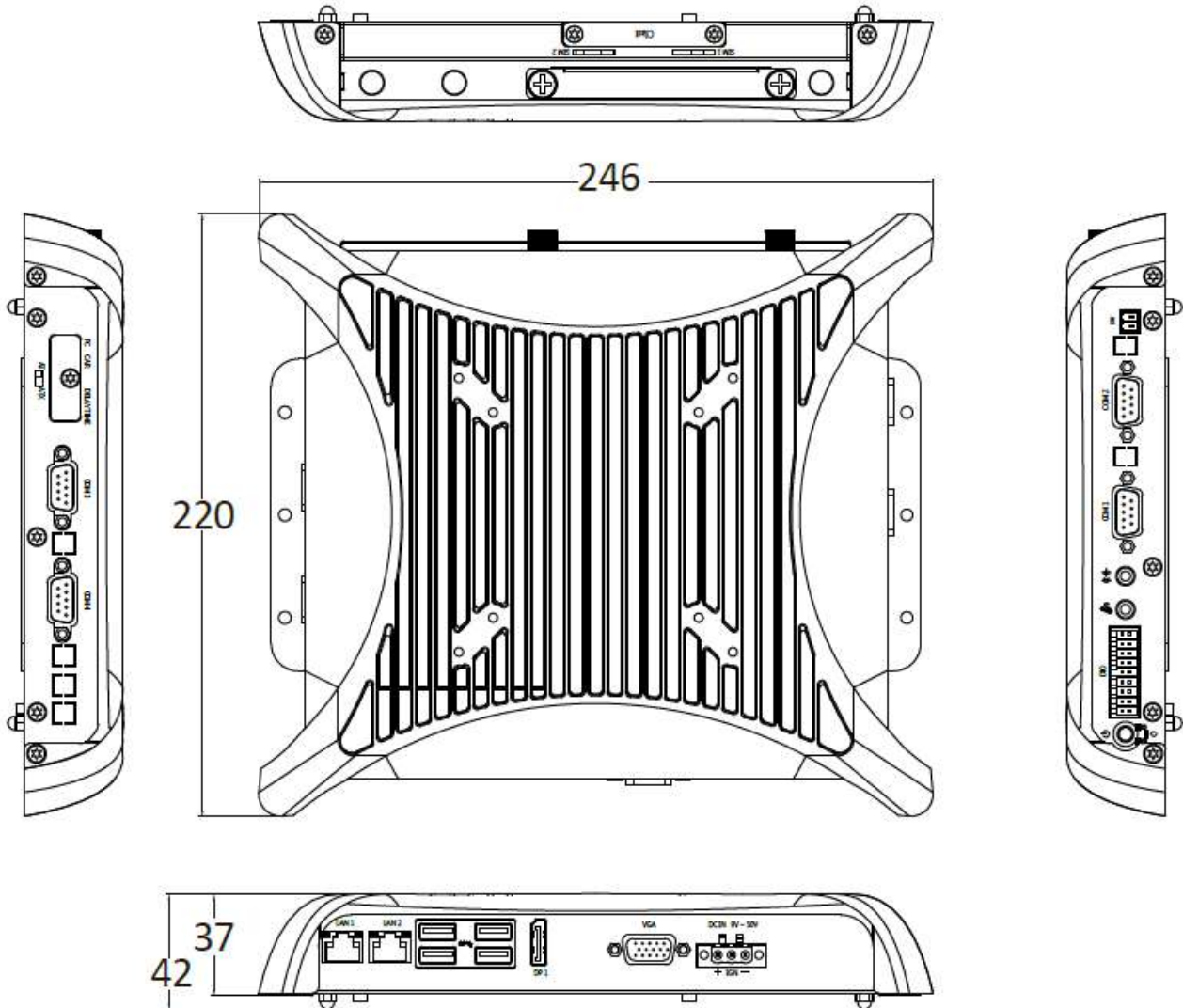



### 1.4.2 PC410

Unit: mm

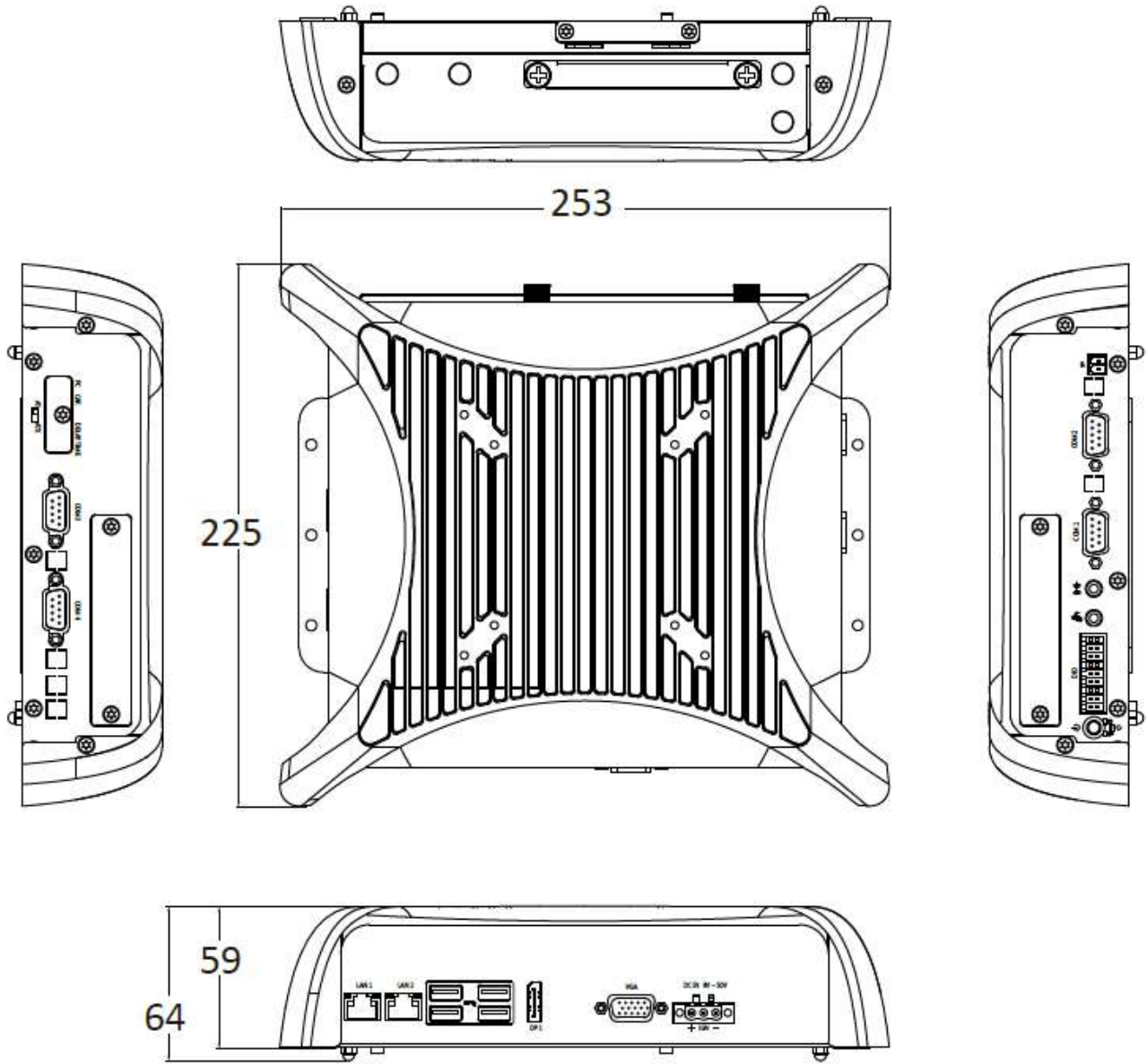

## Chapter 2

# Switches and Connectors

## 2.1 Switch and Connector Locations

### 2.1.1 Top View

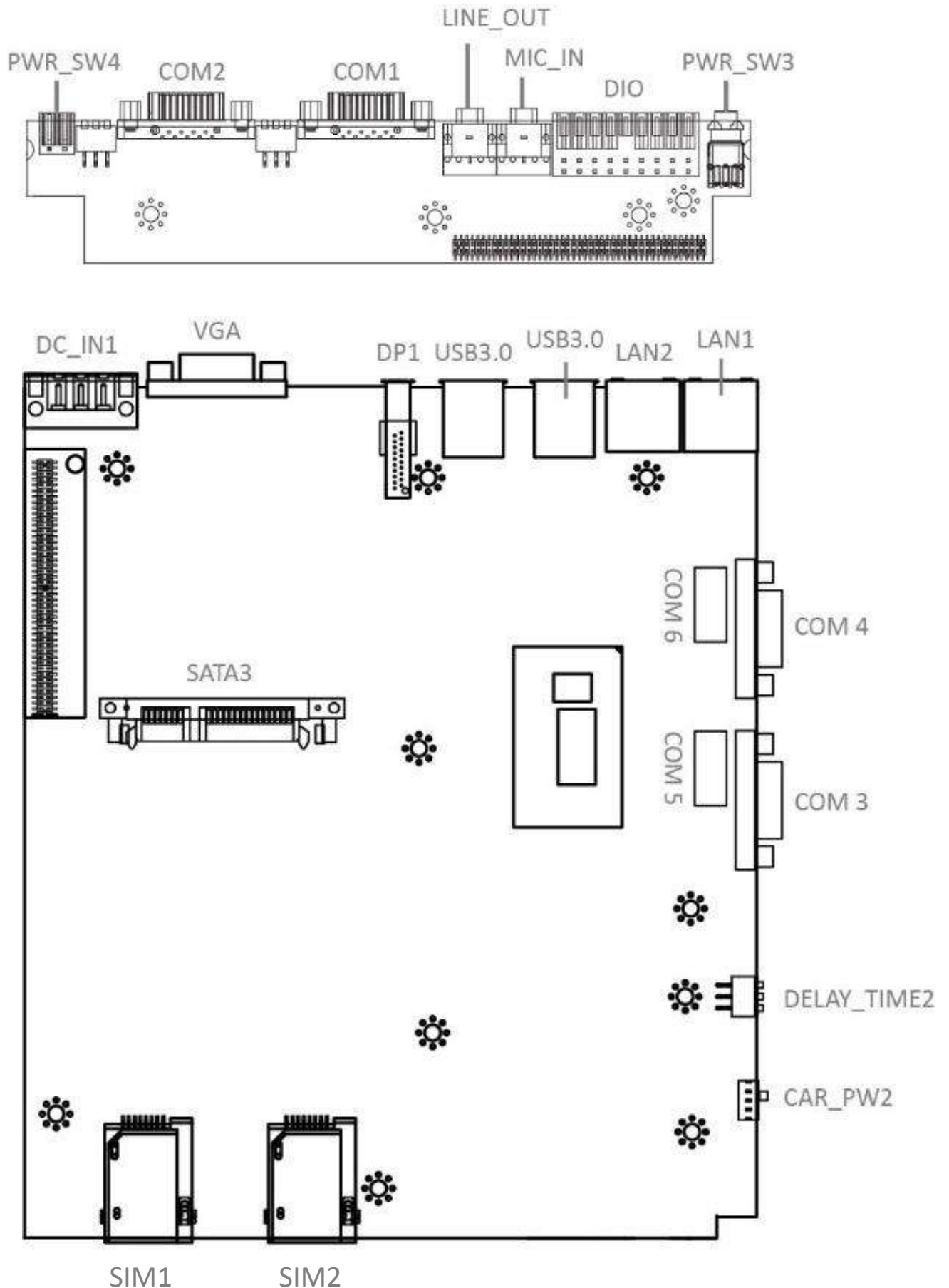

2.1.2 Bottom View

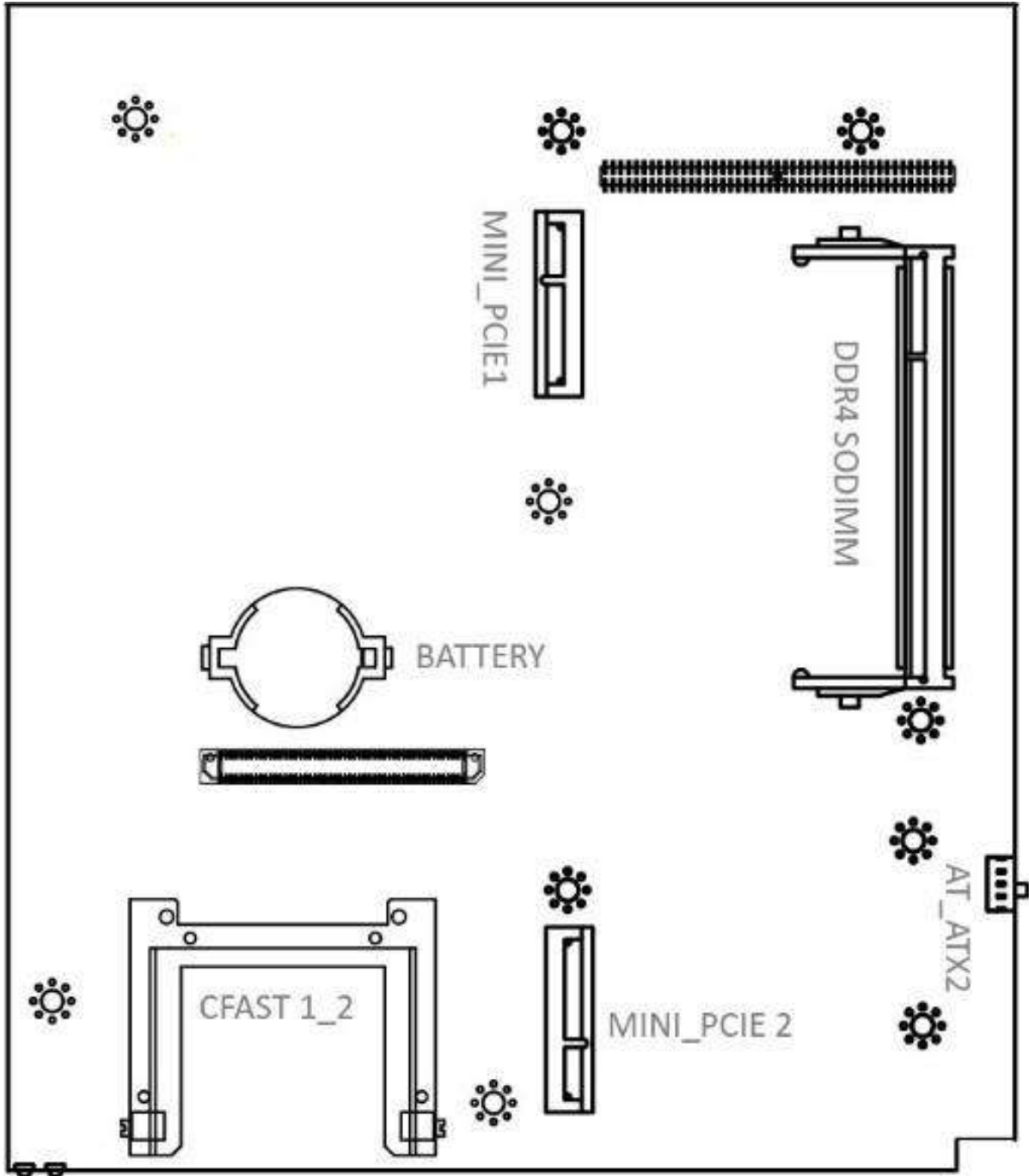

## 2.2 Connector / Switch Definition

### List of Connector / Switch

Connector Location	Definition
AT_ATX2	AT / ATX Power Mode Switch
CLR_CMOS1	Clear BIOS Switch
CAR_PWR2	PC / Car Mode Switch
DELAY_TIME2	Car mode PC turn off delay time
CFAST1_2	CFast Socket
PWR_SW3	Power Switch
RESET2	Reset Switch
USB1_2_1, USB1_2_2	USB 3.0 Port
SIM1_1, SIM2_1	SIM Card Socket
COM1_1, COM2_1, COM3_1, COM4_1	RS232 / RS422 / RS485 Connector
LAN1, LAN2	LAN Port
DC_IN1	3-pin DC 9~50V Power Input Connector
DP1	DisplayPort Connector
LINE_OUT1	Line-out Jack
MIC_IN1	Mic-in Jack
DIO1	8DI / 8DO Connector
PWR_SW4	Remote Power Switch
MINI-PCIE1	Mini PCI-Express / mSATA Socket
MINI-PCIE2	Mini PCI-Express Socket
SATA3	SATA with Power Connector
PWR_LED2	Power LED Status
HDD_LED2	HDD Access LED Status

## 2.3 Switches Definitions

### AT\_ATX1: AT / ATX Power Mode Switch

Switch	Definition
1-2 (Right)	ATX Power Mode ( Default )
2-3 (Left)	AT Power Mode

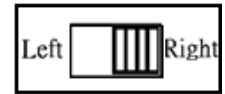

### CLR\_CMOS1: Clear BIOS Switch

Switch	Definition
Off	Normal Status (Default)
ON	Clear BIOS

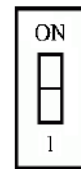

### CAR\_PWR2: PC / Car Mode Switch

Switch	Definition
1-2 (Left)	PC Power Mode ( Default )
2-3 (Right)	Power Ignition Mode

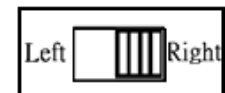

### DELAY\_TIME1: Power off delay time setup Switch

Switch 1 / 2 / 3	Definition
ON / ON / ON	3 sec. ( Default Shutdown Timer by O.S )
ON / ON / OFF	1 min.
ON / OFF / ON	5 min.
ON / OFF / OFF	10 min.
OFF / ON / ON	30 min.
OFF / ON / OFF	1 hour
OFF / OFF / ON	2 hour

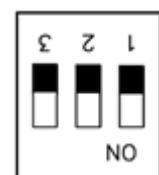

### Step of Setting Power Ignition

Step 1:

To select power ignition by PC/CAR switch.

Step 2:

To configure the power off delay time, please check the Delay Time Setting Options in advance.

Step 3:

To connect the power and ignition power

Step 3

Switch 1 / 2 / 3	Power off delay time
ON / ON / ON	3 second
ON / ON / OFF	1 minute
ON / OFF / ON	5 minutes
ON / OFF / OFF	10 minutes
OFF / ON / ON	30 minutes
OFF / ON / OFF	1 hour
OFF / OFF / ON	2 hours

Step 1  
 Pin 1-2 (Right): PC Mode  
 Pin 2-3 (Left): Power Ignition Mode

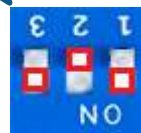

Step 3  
 To connect the battery power and ignition signal



### Example: Delay Time Setting for 5 minutes

1. If delay time set as "5 minutes"



2. The system will shut down 5 minutes later after turning off the vehicle.



## 2.4 Connectors Definitions

### CFAST1\_2: CFast Socket

Pin	Definition	Pin	Definition	Pin	Definition
S1	GND	PC1	NC	PC10	NC
S2	SATA_TXP1	PC2	GND	PC11	NC
S3	SATA_TXN1	PC3	NC	PC12	NC
S4	GND	PC4	NC	PC13	+3.3V
S5	SATA_RXN1	PC5	NC	PC14	+3.3V
S6	SATA_RXP1	PC6	NC	PC15	GND
S7	GND	PC7	GND	PC16	GND
		PC8	NC	PC17	NC
		PC9	NC		

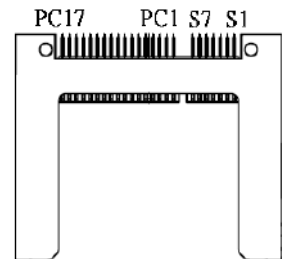

### PWR\_SW2: Power Button

Pin	Definition	Pin	Definition
1	NC	4	GND
2	Power Button	5	NC
3	NC	6	GND

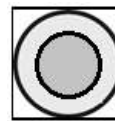

### RESET2 : Reset Button

Pin	Definition
1	RESET
2	GND



### USB3.0 Connector, Type A

Pin	Definition	Pin	Definition
1	+5V	6	USB3_RX+
2	USB2_D-	7	GND
3	USB2_D+	8	USB3_TX-
4	GND	9	USB3_TX+
5	USB3_RX-		

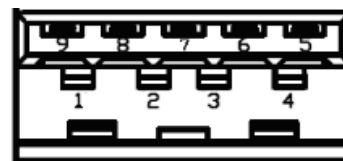



**SIM1, SIM2: SIM Card Socket**

Pin	Definition	Pin	Definition
C1	UIM_PWR	C6	UIM_VPP
C2	UIM_RESET	C7	UIM_DATA
C3	UIM_CLK	CD	NC
C5	GND	COM	GND

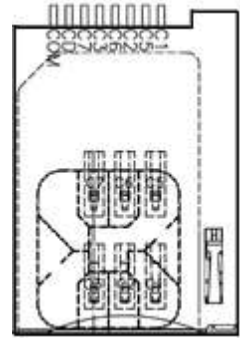

**COM: RS232 / RS422 / RS485 Connector**

Connector Type: 9-pin D-Sub

Pin	RS232 Definition	RS422 / 485 Full Duplex Definition	RS485 Half Duplex Definition
1	DCD	TX-	DATA-
2	RxD	TX+	DATA+
3	TxD	RX+	
4	DTR	RX-	
5	GND	GND	GND
6	DSR		
7	RTS		
8	CTS		
9	RI		

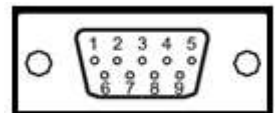

**COM: RS232 / RS422 / RS485 Connector**

Connector Type: 2X5 10-pin box header, 2.54mm pitch

Pin	RS232 Definition	RS422 / 485 Full Duplex Definition	RS485 Half Duplex Definition
1	DCD	TX-	DATA-
2	DSR		
3	RxD	TX+	DATA+
4	RTS		
5	TxD	RX+	
6	CTS		
7	DTR	RX-	
8	RI		
9	GND	GND	GND
10	NC	NC	NC

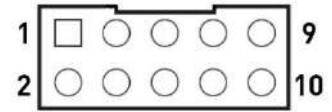

**DC\_IN1: DC Power Input Connector (+9~50V)**

Connector Type: Terminal Block 1X3 3-pin, 5.0mm pitch

Pin	Definition
1	+9~50VIN
2	Car power detect (ACC in)
3	GND

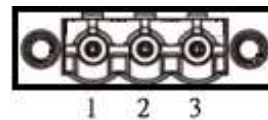

**VGA: Standard VGA Connector**

Connector Type: 15-pin D-Sub

Pin	Definition	Pin	Definition
1	RED	9	+5V
2	GREEN	10	S_GND
3	BLUE	11	NC
4	NC	12	SDA
5	GND	13	HSYNC
6	R_GND	14	VSYNC
7	G_GND	15	SCL
8	B_GND		

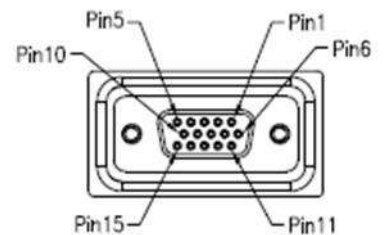

**DP: DisplayPort Connector**

Pin	Definition	Pin	Definition
1	DP_LANE0_P	11	GND
2	GND	12	DP_LANE3_N
3	DP_LANE0_N	13	GND
4	DP_LANE1_P	14	GND
5	GND	15	DP_AUX_P
6	DP_LANE1_N	16	GND
7	DP_LANE2_P	17	DP_AUX_N
8	GND	18	DP_HPD
9	DP_LANE2_N	19	GND
10	DP_LANE3_P	20	+3.3V

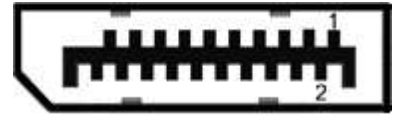

**LINE\_OUT1 : Line-out Jack (Green)**

Connector Type: 5-pin Phone Jack

Pin	Definition
1	GND
2	OUT_R
3	NC
4	GND
5	OUT_L



**MIC\_IN1: Microphone Jack (Pink)**

Connector Type: 5-pin Phone Jack

Pin	Definition
1	GND
2	MIC_R
3	NC
4	GND
5	MIC_L



**DIO1: Digital Input / Output Connector**

Connector Type: Terminal Block 2X9 18-pin, 3.5mm pitch

Pin	Definition	Pin	Definition
1	DIN1	2	DOUT1
3	DIN2	4	DOUT2
5	DIN3	6	DOUT3
7	DIN4	8	DOUT4
9	DIN5	10	DOUT5
11	DIN6	12	DOUT6
13	DIN7	14	DOUT7
15	DIN8	16	DOUT8
17	DC power input (+5V~+30V)	18	GND

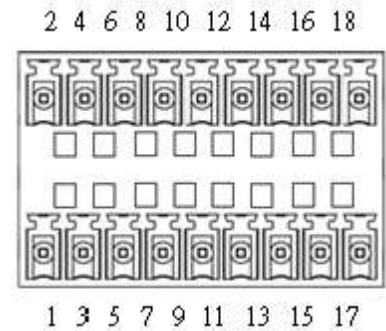

Reference Input Circuit

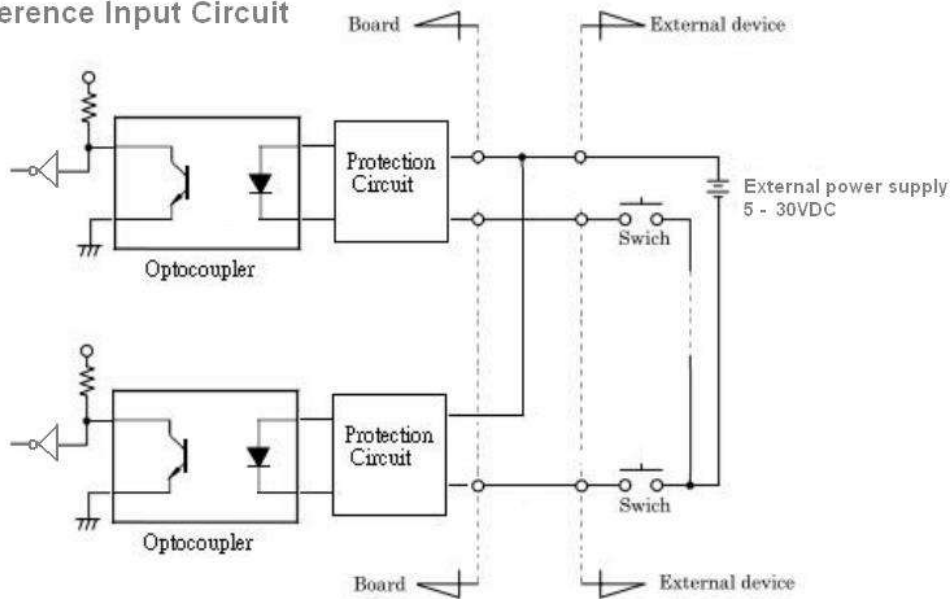

External Output Circuit

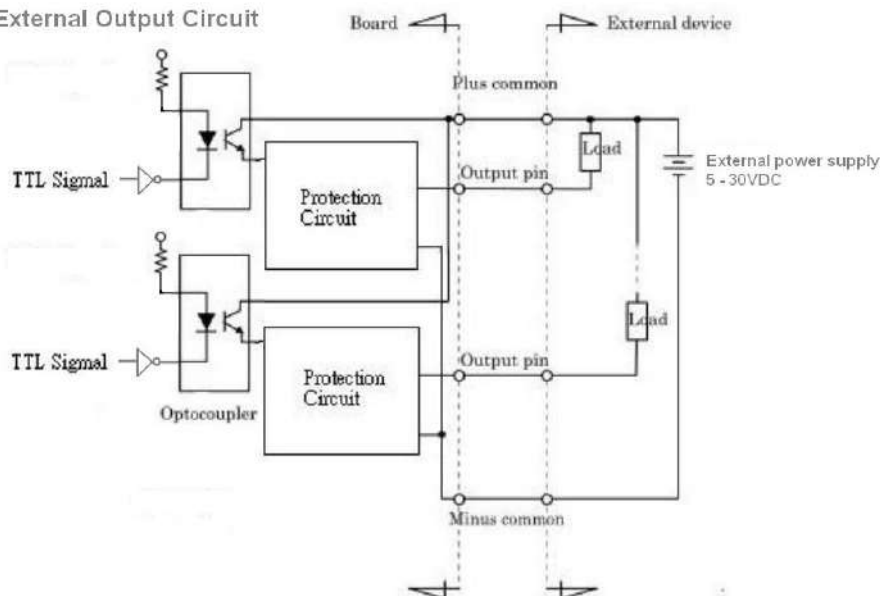

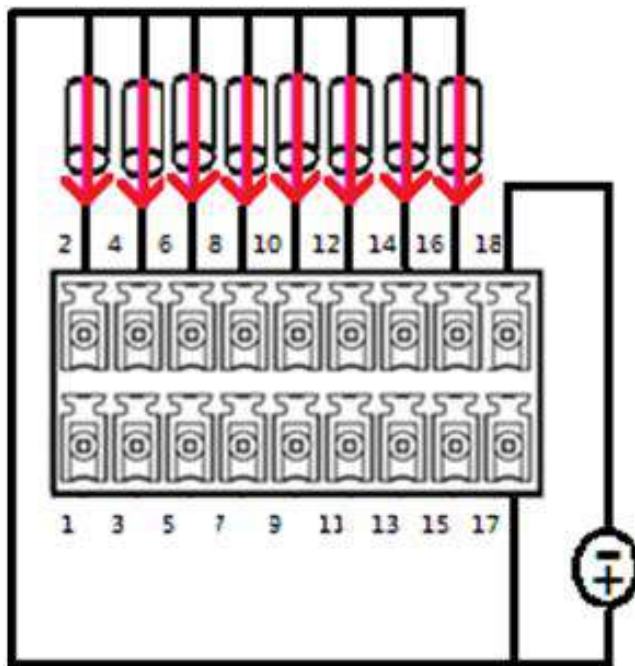
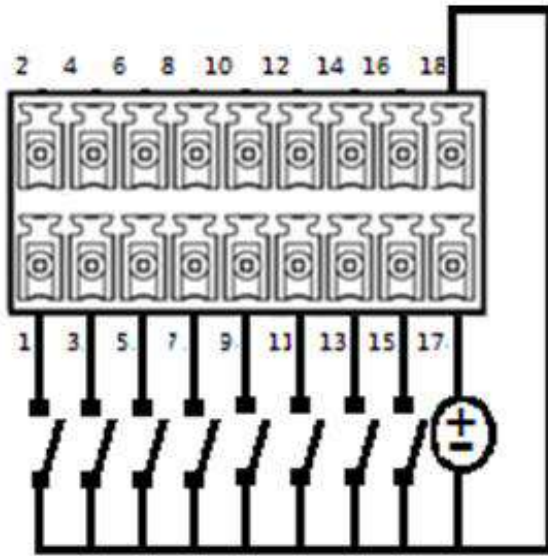

**PWR\_SW1 : Remote Power Switch**

Connector Type: Terminal Block 1X2 2-pin, 3.5mm pitch

Pin	Definition
1	Power Button
2	GND



**LAN1, LAN2: RJ45 with LEDs Port**

Connector Type: RJ45 Connector

Pin	Definition	Pin	Definition
1	LAN_MDI0P	5	LAN_MDI2N
2	LAN_MDI0N	6	LAN_MDI1N
3	LAN_MDI1P	7	LAN_MDI3P
4	LAN_MDI2P	8	LAN_MDI3N

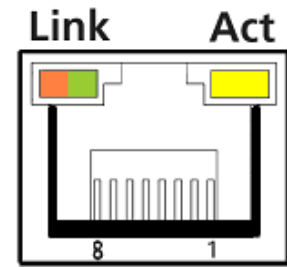

Act LED Status	Definition
Blinking Yellow	Data Activity
Off	No Activity

Link LED Status	Definition
Steady Orange	1Gbps Network Link
Steady Green	100Mbps Network Link
Off	10Mbps Network Link

**SATA with Power Connector**

Pin	SATA1_1 Definition	Pin	SATA1_1 Definition
1	GND	12	GND
2	TxP	13	GND
3	TxN	14	+5V
4	GND	15	+5V
5	RxN	16	+5V
6	RxP	17	GND
7	GND	18	GND
8	NC	19	GND
9	NC	20	+12V
10	DEVSLP	21	+12V
11	GND	22	+12V

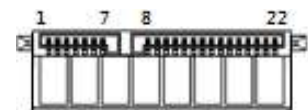

**MINIPCI1: Mini PCI-Express / mSATA Socket**

Pin	Definition	Pin	Definition	Pin	Definition
1	WAKE#	19	NC	37	GND
2	+3.3V	20	NC	38	USB2_D+
3	NC	21	GND	39	+3.3V
4	GND	22	RESET#	40	GND
5	NC	23	RxN	41	+3.3V
6	+1.5V	24	+3.3VAUX	42	NC
7	CLKREQ#	25	RxP	43	GND
8	UIM_PWR	26	GND	44	DEVSLP
9	GND	27	GND	45	NC
10	USIM_DATA	28	+1.5V	46	NC
11	REFCLK-	29	GND	47	NC
12	UIM_CLK	30	SMB_CLK	48	+1.5V
13	REFCLK+	31	TxN	49	NC
14	UIM_RST	32	SMB_DATA	50	GND
15	GND	33	TxP	51	PCIE_MSATA_SEL
16	USIM_VPP	34	GND	52	+3.3V
17	NC	35	GND		
18	GND	36	USB2_D-		

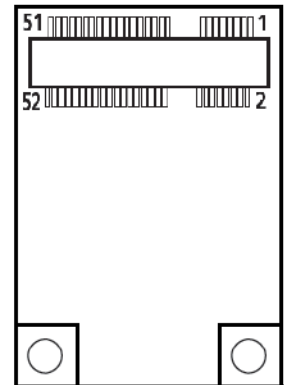
**MINIPCI2: Mini PCI-Express Socket**

Pin	Definition	Pin	Definition	Pin	Definition
1	WAKE#	19	NC	37	GND
2	+3.3V	20	NC	38	USB2_D+
3	NC	21	GND	39	+3.3V
4	GND	22	RESET#	40	GND
5	NC	23	RxN	41	+3.3V
6	+1.5V	24	+3.3VAUX	42	NC
7	CLKREQ#	25	RxP	43	GND
8	UIM_PWR	26	GND	44	NC
9	GND	27	GND	45	NC
10	UIM_DATA	28	+1.5V	46	NC
11	REFCLK-	29	GND	47	NC
12	UIM_CLK	30	SMB_CLK	48	+1.5V
13	REFCLK+	31	TxN	49	NC
14	UIM_RST	32	SMB_DATA	50	GND
15	GND	33	TxP	51	NC
16	UIM_VPP	34	GND	52	+3.3V
17	NC	35	GND		
18	GND	36	USB2_D-		

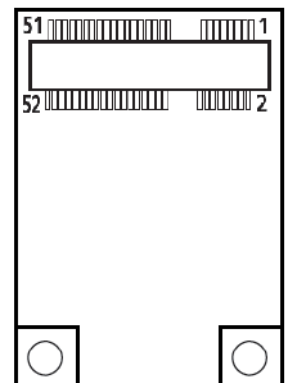

**PWR\_LED2: Power LED Status**

Pin	Definition
1	POWER LED+
2	POWER LED-

**HDD\_LED2: HDD Access LED Status**

Pin	Definition
1	HDD LED+
2	HDD LED-





## Chapter 3

# System Setup

## 3.1 Set torque force to 3.5 kgf-cm to execute all the screwing and unscrewing

**WARNING**

In order to prevent electric shock or system damage, before removing the chassis cover, must turn off power and disconnect the unit from power source.

## 3.2 Installing SODIMM

1. Remove SODIMM cover in the below circled area for installing memory module.

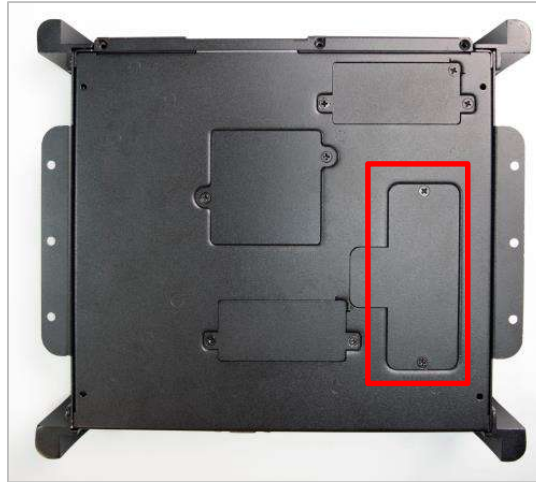

2. Insert memory module from 45 degree direction.



3. Press the memory module vertically downward until you hear the "click" sound. Make sure the memory module is firmly in place.



### 3.3 Installing mini PCIe card / mSATA

1. Two mini PCIe slots are available for PC400 series. MiniPCIe1 supports mSATA.

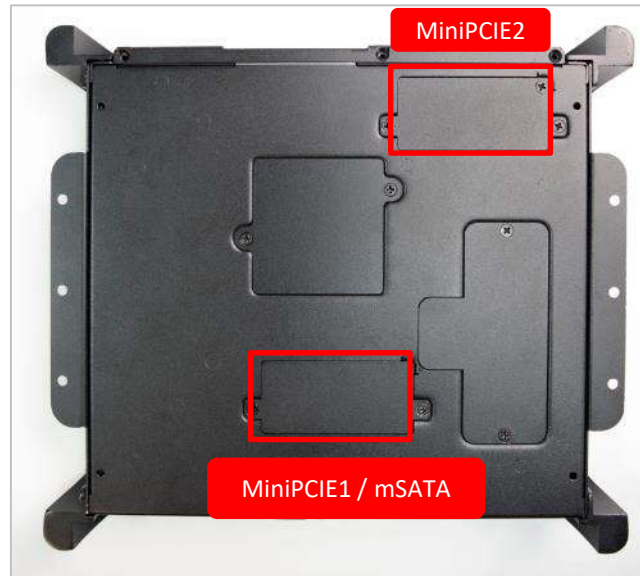

2. Insert mini PCIe card or mSATA module from 45 degree direction.



3. Press the mini PCIe card or mSATA module down and lock it with two screws (M2x3.7L).



### 3.4 Installing HDD on removable STAT HDD bay

1. One removable SATA HDD bays is available for PC400 Series



2. Unscrew the two sun screws circled below to take out the removable SATA HDD bay.



3. Lock the 2.5" HDD with HDD bracket using four screws (M3x4L).



4. Slide the HDD bracket back and then fasten the sun screws.





### 3.5 Installing CFast card

1. One CFast socket is available for PC100 series. Unscrew two screws to remove the bracket.



2. Insert CFast card into the socket until you hear the “click” sound.

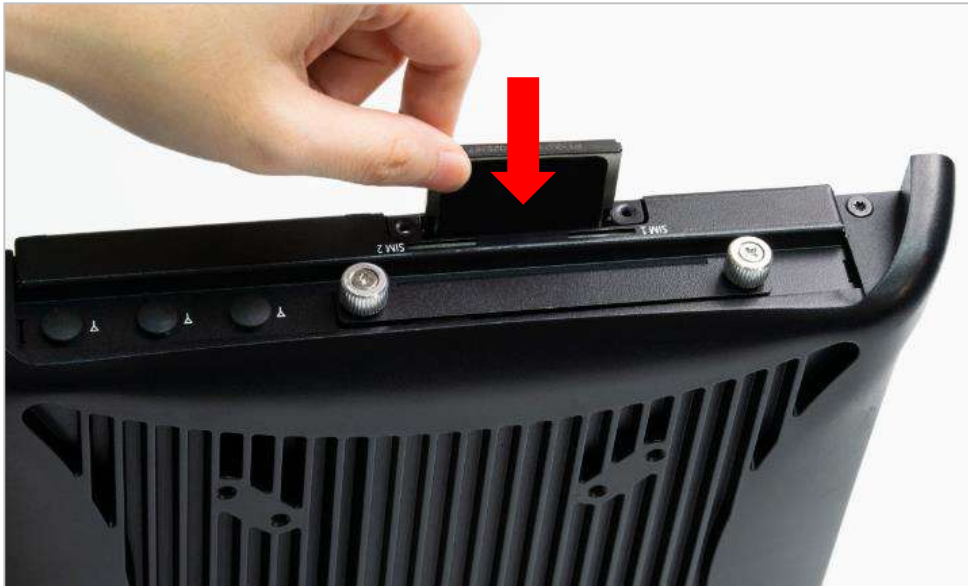

3. The socket is push-push type. Push the installed CFast card again to remove it.



## 3.6 Installing SIM card

1. For PC400 Series, two SIM card slots are available on system chassis between removable HDD bay and CFast slot.



2. Press the SIM card in until you hear the “click” sound.



- Please note that the installation of SIM 1 and SIM 2 has to match the installation of mini PCIe slots.

SIM Card Socket Number	Matching Mini PCIe Slot
SIM 1	Mini PCIe 2 (CN2)
SIM 2	Mini PCIe 1 / mSATA (CN1)

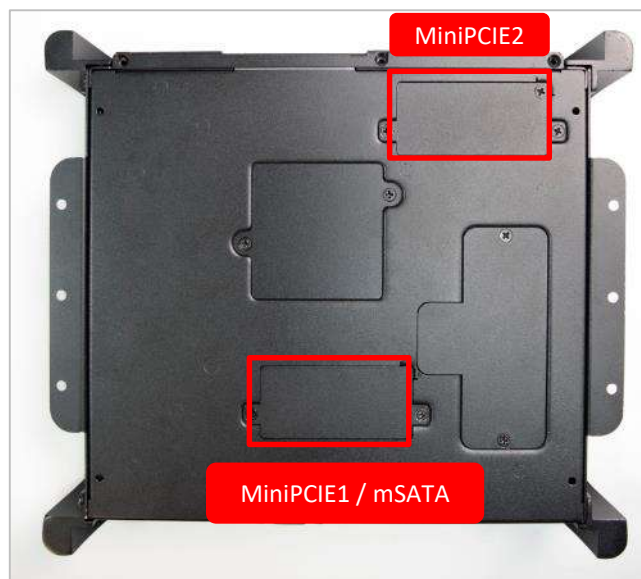

- To uninstall SIM card, simply press the installed SIM card and then the card will be pushed out



### 3.7 Removing chassis top cover

1. Unscrew the 6 screws (M3x5L) below.



2. Now you can remove the top cover of PC module.



## 3.8 Installing antenna

1. Three antenna holes are available for PC400 series.



2. Remove antenna hole cover on the system panel.



3. Have antenna jack penetrate through the hole.



4. Put on washer and fasten the nut with antenna jack.



5. Attach the RF connector at the cable-end onto the communication module.

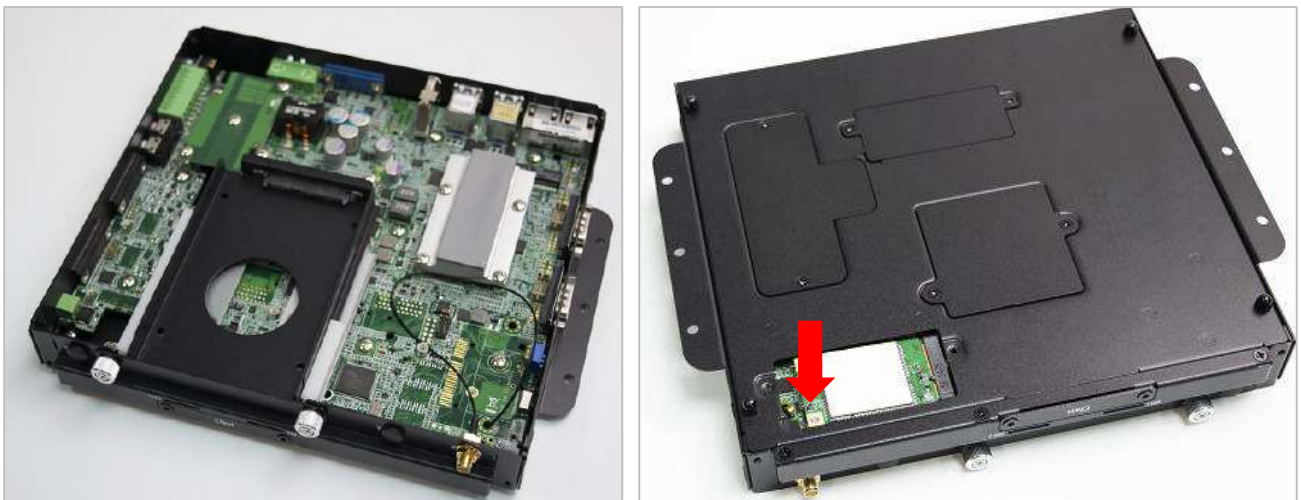

6. Assemble the antenna and antenna jack together.





### 3.9 Assembling chassis top cover

1. Ensure thermal pad is in place on the CPU thermal block.



2. Close the chassis top cover following the below direction and make sure the aluminum part on the top cover is touching the thermal pad on CPU thermal block.



3. Fasten the 6 screws (M3x5L) to lock the system body with top cover.



### 3.10 Connecting PC module with VIO display module

1. Hold the PC module with its connector facing towards the connector on the back of VIO display module.



2. Press the PC module downward to ensure two modules are firmly connected.



3. Lock the below 6 screws (M4X5L) to finish assembly.



## Chapter 4

# BIOS Setup

## 4.1 BIOS Introduction

The system BIOS software is stored on EEPROM. The BIOS provides an interface to modify the configuration. When the battery is removed, all the parameters will be reset.

### BIOS Setup

Power on the embedded system and by pressing <Del> immediately allows you to enter the setup screens. If the message disappears before you respond and you still wish to enter the Setup, restart the system by turning it OFF and ON or pressing the RESET button.

You may also restart the system by simultaneously pressing <Ctrl>, <Alt>, and <Delete> keys.

Control Keys	
<→> <←>	Select Screen
<↑> <↓>	Select Item
<Enter>	Select
<Page Up/+>	Increases the numeric value or makes changes
<Page Down/->	Decreases the numeric value or makes changes
<F1>	General Help
<F2>	Previous Value
<F3>	Load Optimized Defaults
<F4>	Save Configuration and Exit
<Tab>	Select Setup Fields
<Esc>	Exit BIOS Setup

### Main Setup

The main menu lists the setup functions you can make changes to. You can use the arrow keys ( ↑↓ ) to select the item. The on-line description of the highlighted setup function is displayed at the bottom of the screen.

### General Help <F1>

The BIOS setup program provides a General Help screen. You can call up this screen from any menu by simply pressing <F1>. The Help screen lists the appropriate keys to use and the possible selections for the highlighted item. Press <Esc> to exit the Help screen.



## 4.2 Main Setup

Press <Del> to enter BIOS CMOS Setup Utility. The Main setup screen is showed as following when the setup utility is entered. System Date/Time is set up in the Main Menu.

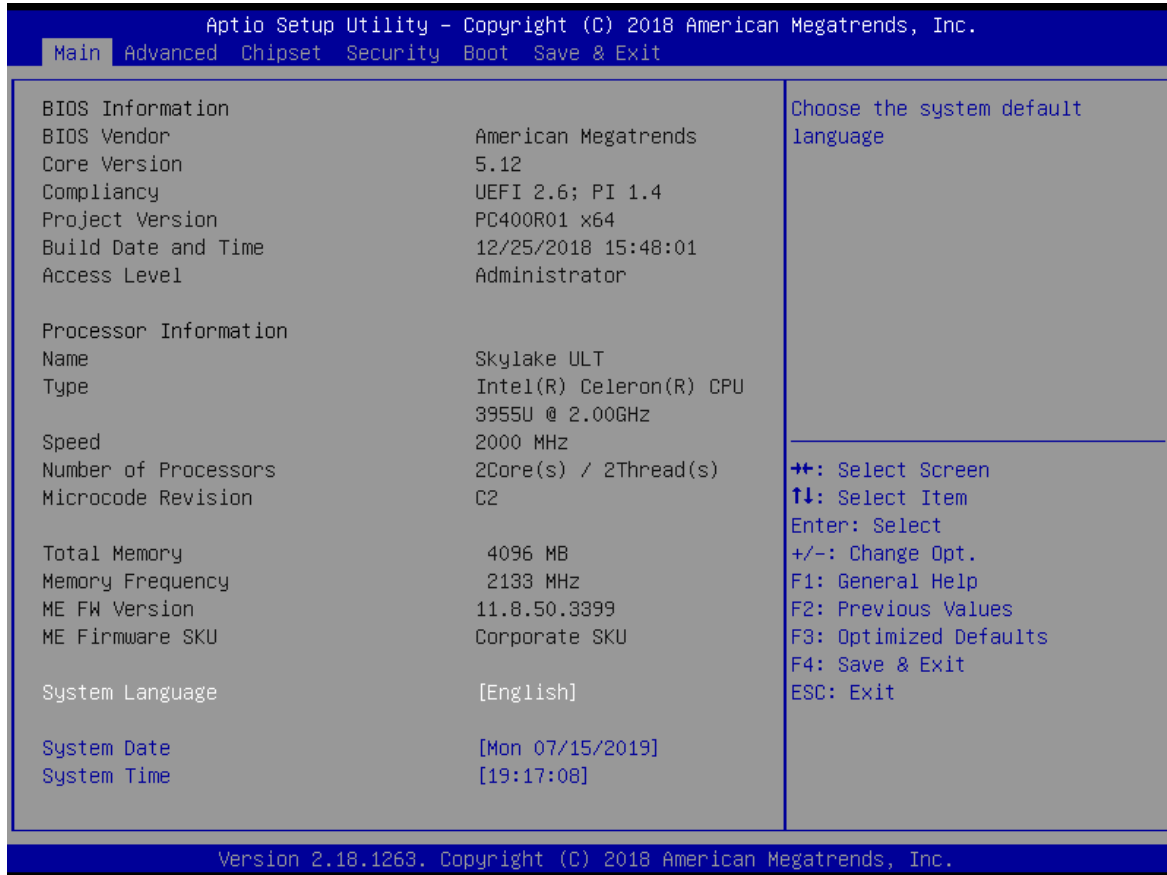

### ■ System Date

Set the system date. Please use <Tab> to switch between data elements.

### ■ System Time

Set the system time. Please use <Tab> to switch between time elements.

## 4.3 Advanced Setup

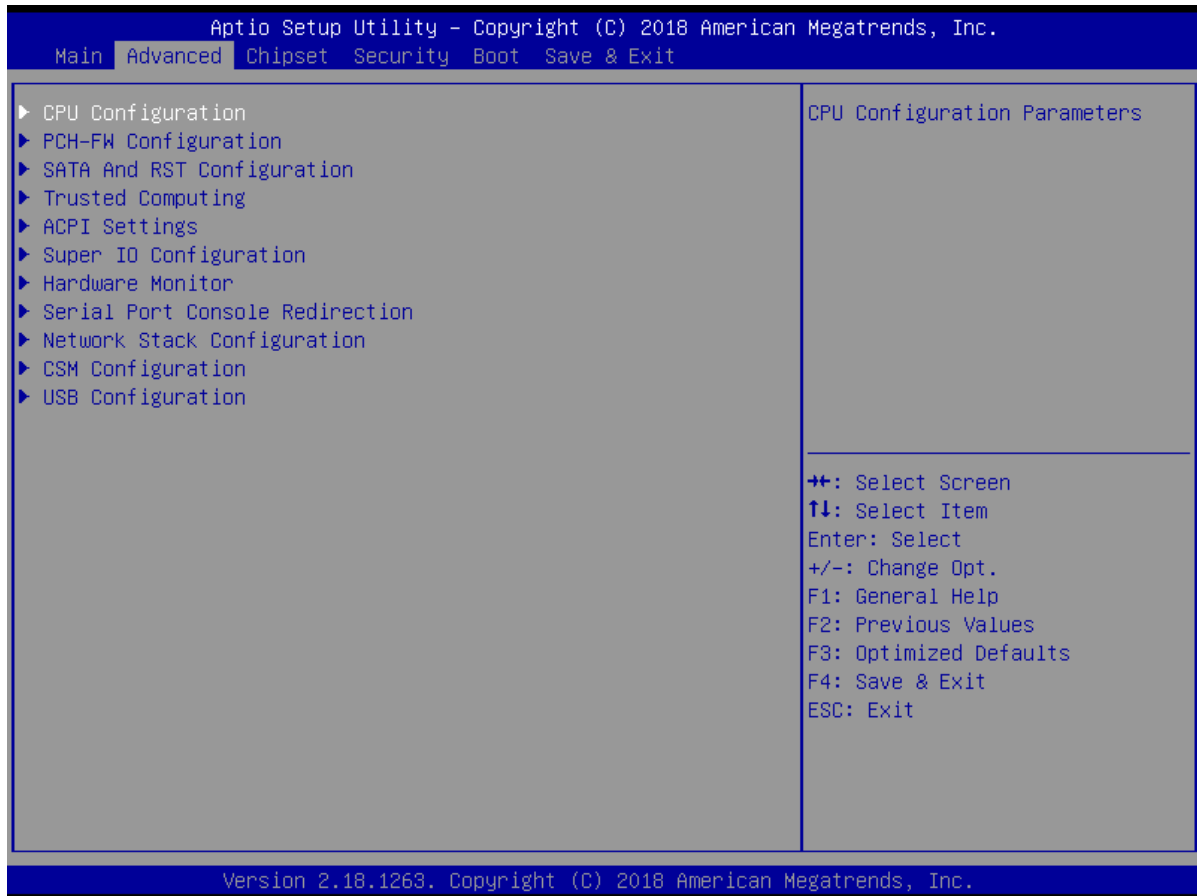

### 4.3.1 CPU Configuration

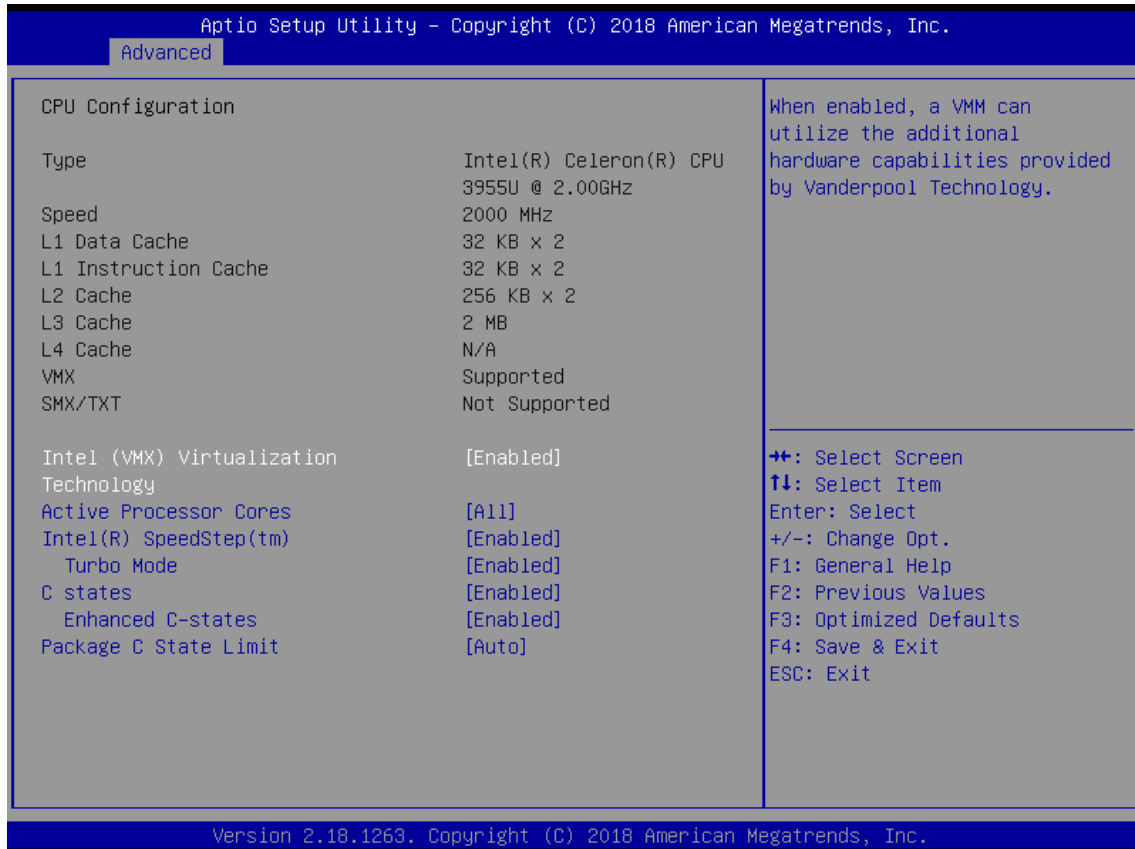

#### ■ Intel Virtualization Technology

Virtualization enhanced by Intel Virtualization Technology will allow a platform to run multiple operating systems and applications in independent partitions. With virtualization, one computer system can function as multiple Virtual systems.

#### ■ Active Processor Cores

Set number of cores to be enabled. Select <All>, <1>, <2>, <3>, <4>, <5>, <6>, <7>, or <8> mode.

#### ■ Intel SpeedStep

This item allows you to enable or disable the Intel SpeedStep.

##### ● Turbo Mode

This item allows you to enable or disable the Turbo Mode.

#### ■ CPU C states

This item allows you to set the power saving of the CPU states.

##### ● Enhanced C States

This item allows your CPU reduce power consumption.

#### ■ Package C State limit

Select Auto for the AMI BIOS to automatically set the limit on the C-State package register. The options are C0/ C1, C2, C3, C6, C7, C7s, C8 and No Limit.

### 4.3.2 PCH-FW Configuration

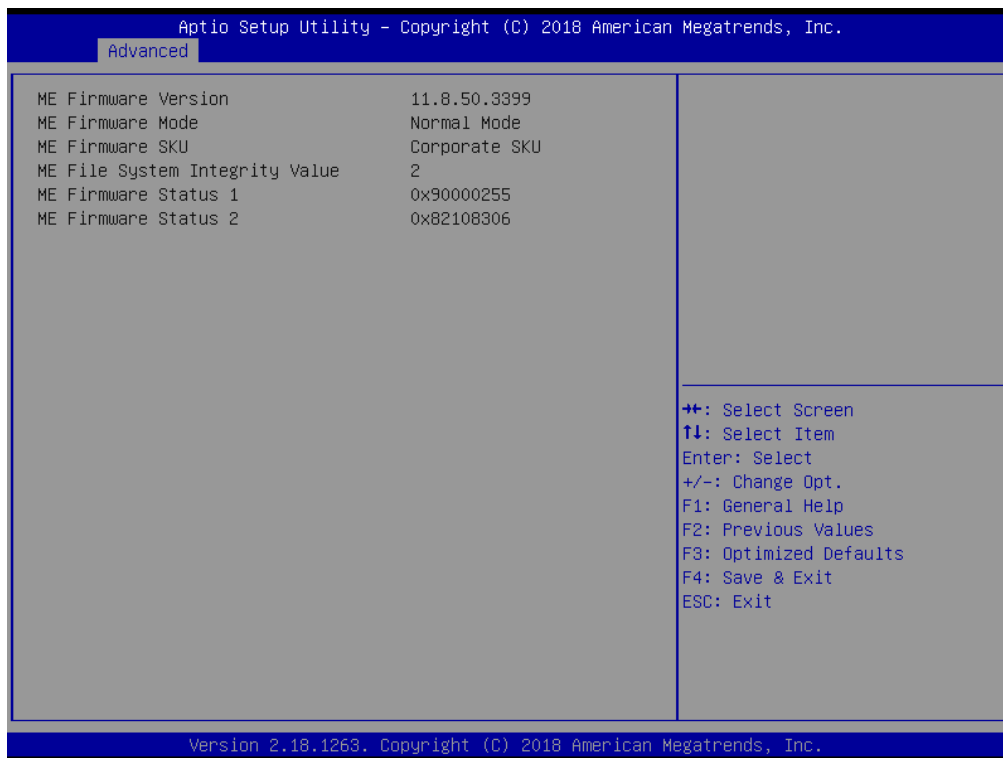

### 4.3.3 SATA and RST Configuration

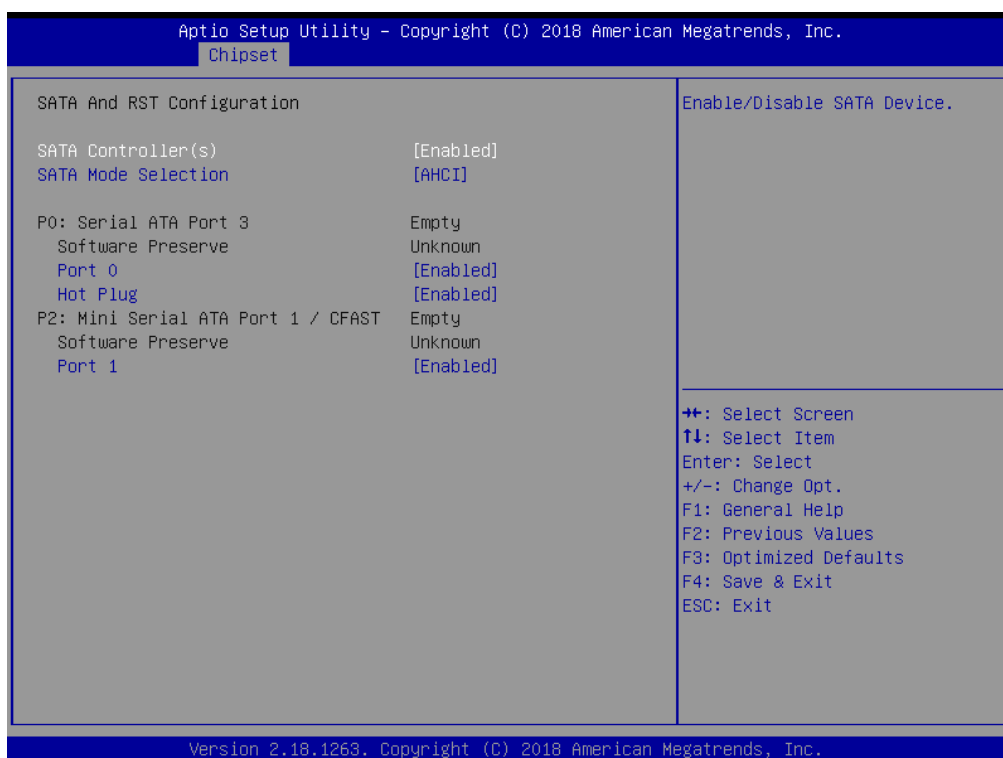

#### ■ SATA Controller(s)

Enable or disable Serial ATA controller.

#### ■ SATA Mode Selection

This item allows users to select mode of SATA controller.

#### ■ Serial ATA Port 0 / 1 / 2

This item allows users to enable or disable Serial ATA Port 0 / 1 / 2.

### 4.3.4 RST (UEFI RAID) Configuration

#### How to set the UEFI RAID:

1. When set to RAID, please save change reset system.

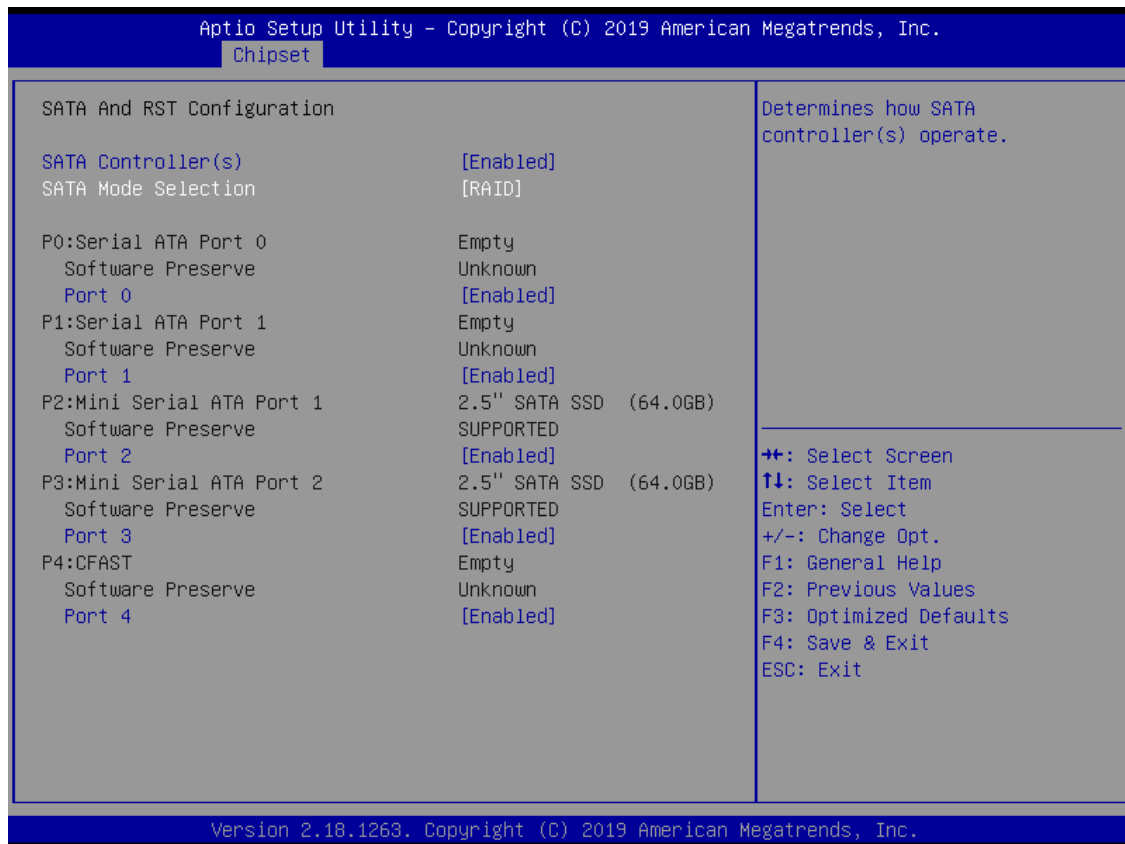

2. After reboot the system, please into BIOS utility and then will see "Intel (R) Rapid Storage Technology"

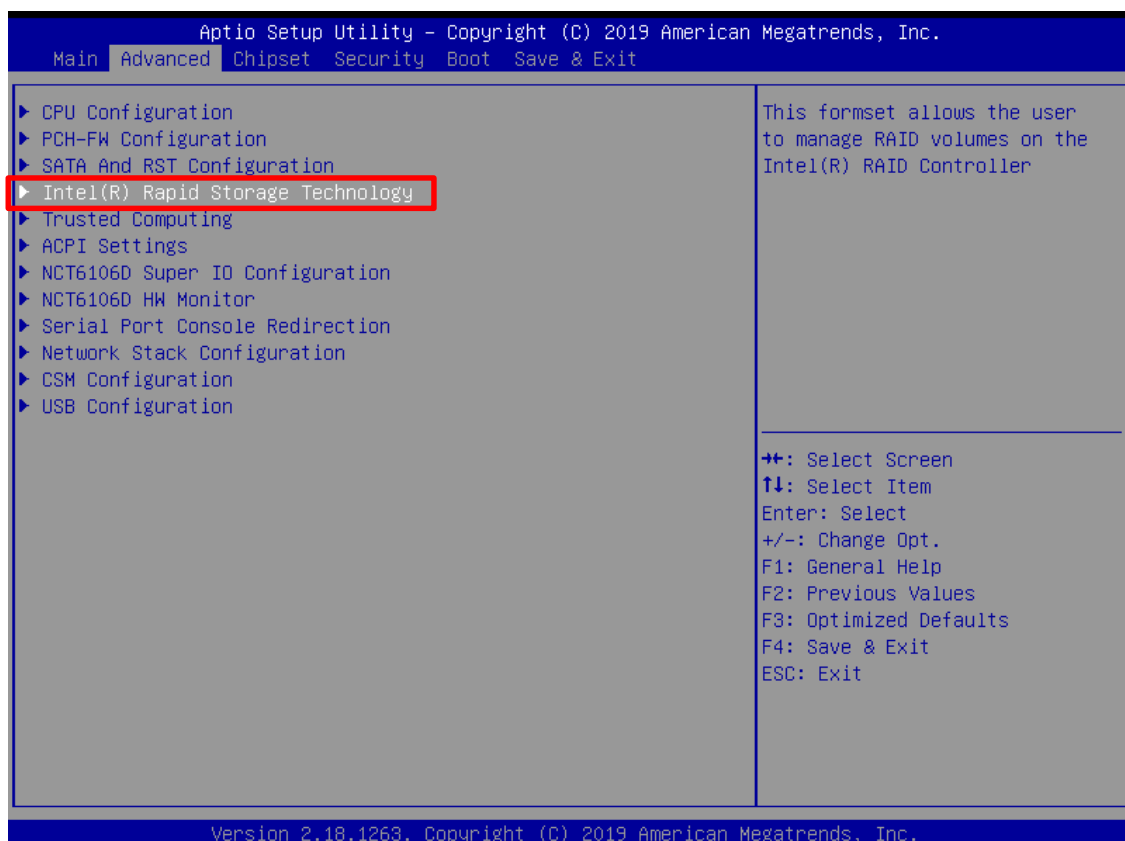

### 3. Into Intel(R) Rapid Storage Technology, and start create RAID volume.

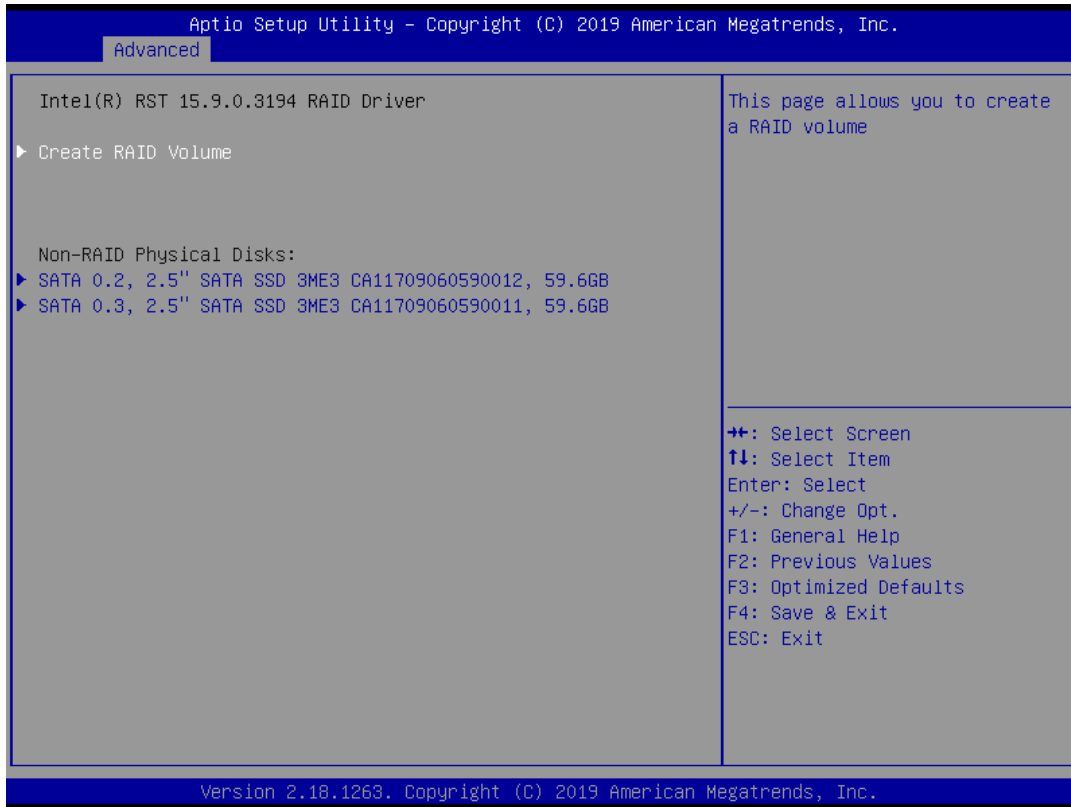

### 4. Start Create the RAID

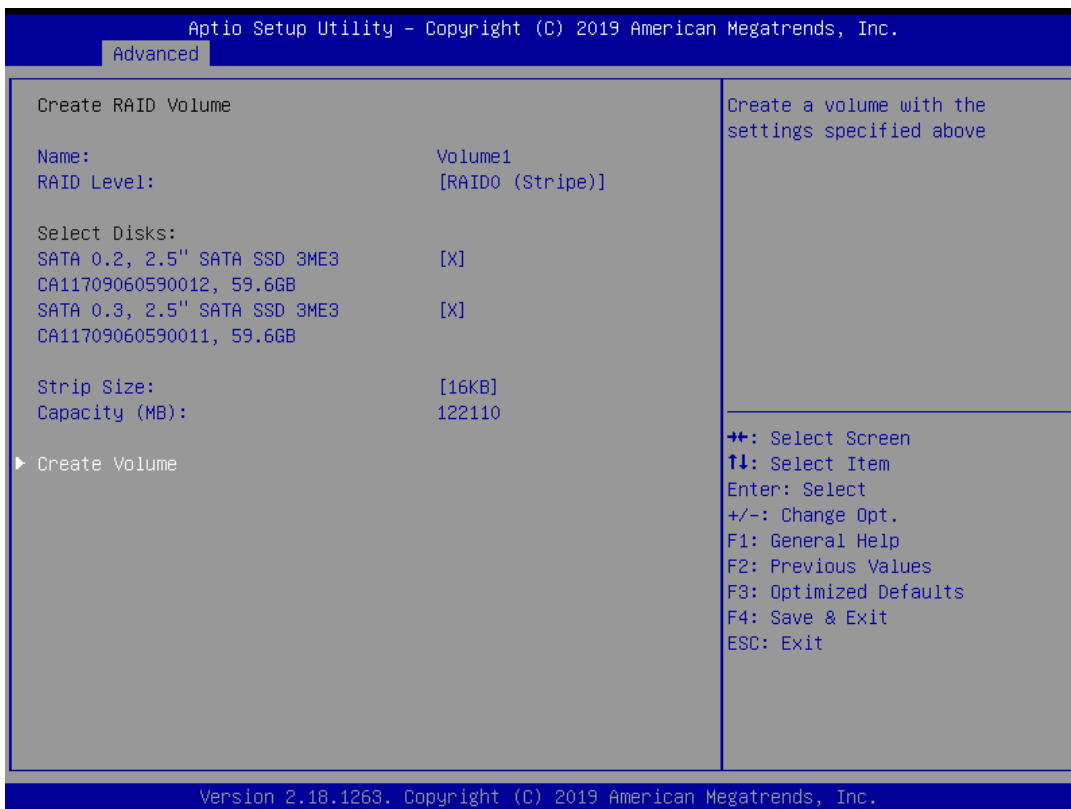

- Select Disk that you want to do the RAID
- Select [x]; No-Select [ ]

### 4.3.5 Trusted Computing



#### ■ Security Device Support

Enable or disable Security Device Support.

### 4.3.6 ACPI Settings

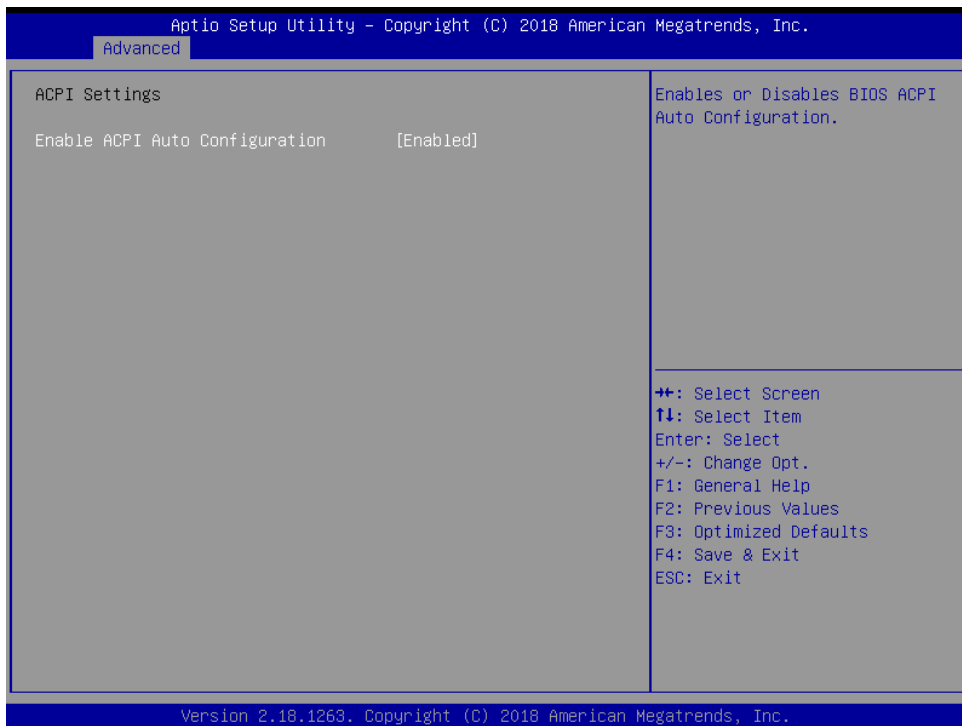

#### ■ Enable ACPI Auto Configuration

Enable or disable ACPI Auto Configuration.

### 4.3.7 Super IO Configuration

This setting allows you to select options for the Super IO Configuration, and change the value of the selected option.

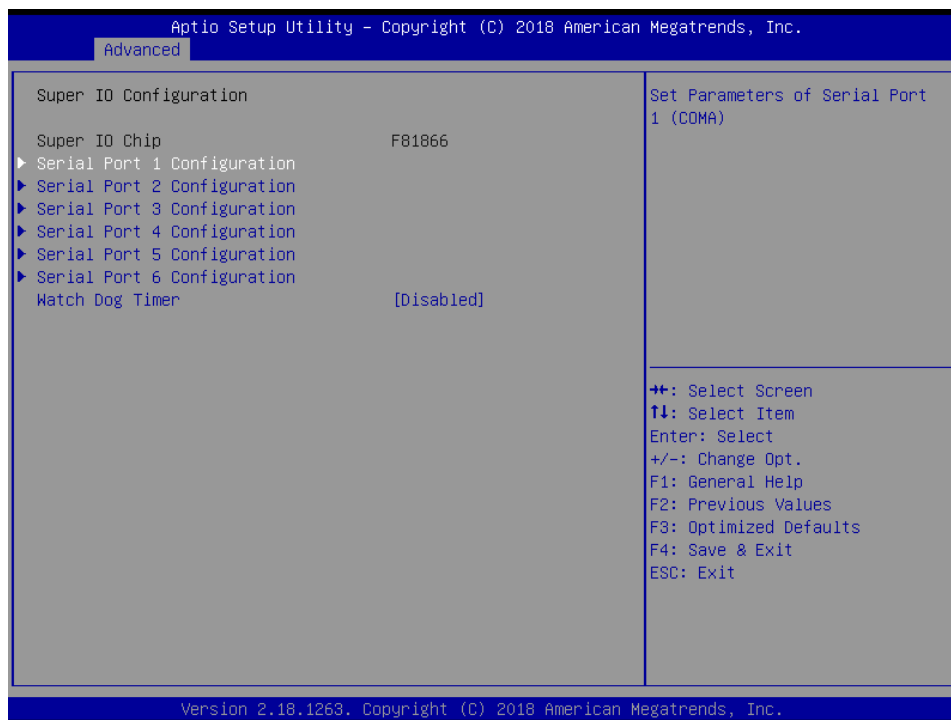

#### Serial Port 1 Configuration

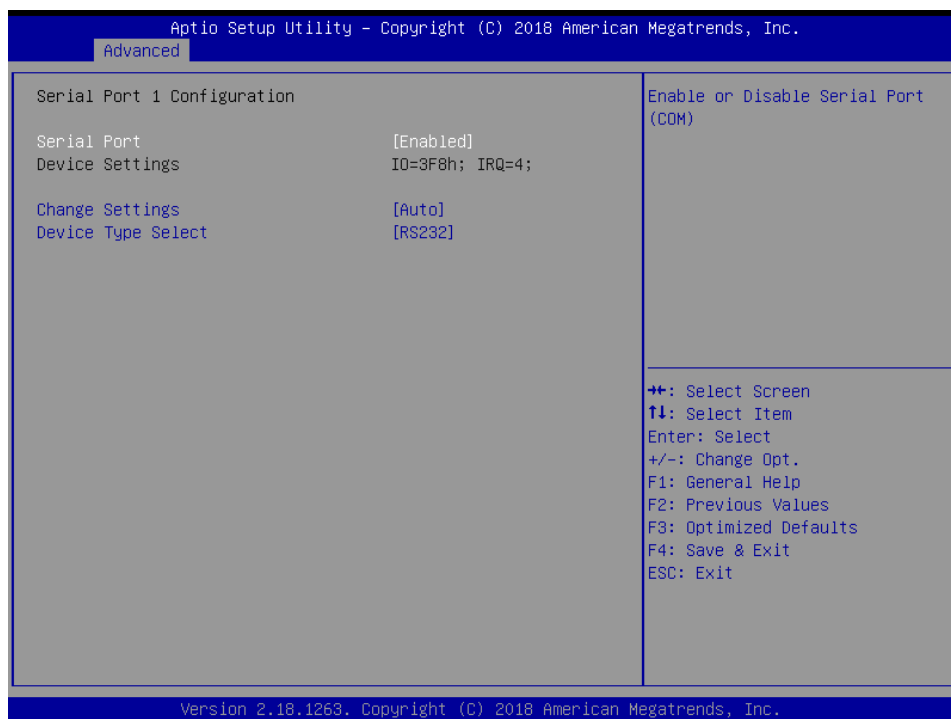

- **Serial Port**  
This item allows you to enable or disable serial port.
- **Change Settings**  
This item allows you to change the address & IRQ settings of the specified serial port.
- **Device Type Select**  
Change the Serial interface. Select <RS232>, <RS422> or <RS485> interface.



## Serial Port 2 Configuration

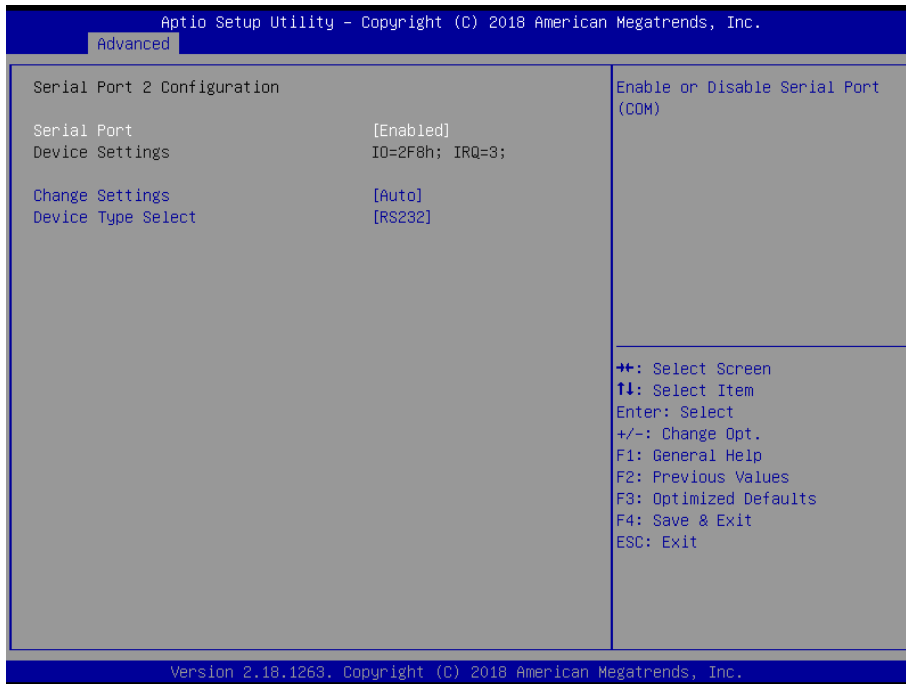

- **Serial Port**  
This item allows you to enable or disable serial port.
- **Change Settings**  
This item allows you to change the address & IRQ settings of the specified serial port.
- **Device Type Select**  
Change the Serial interface. Select <RS232>, <RS422> or <RS485> interface.

## Serial Port 3 Configuration



- **Serial Port**  
This item allows you to enable or disable serial port.
- **Change Settings**  
This item allows you to change the address & IRQ settings of the specified serial port.
- **Device Type Select**  
Change the Serial interface. Select <RS232>, <RS422> or <RS485> interface.

## Serial Port 4 Configuration

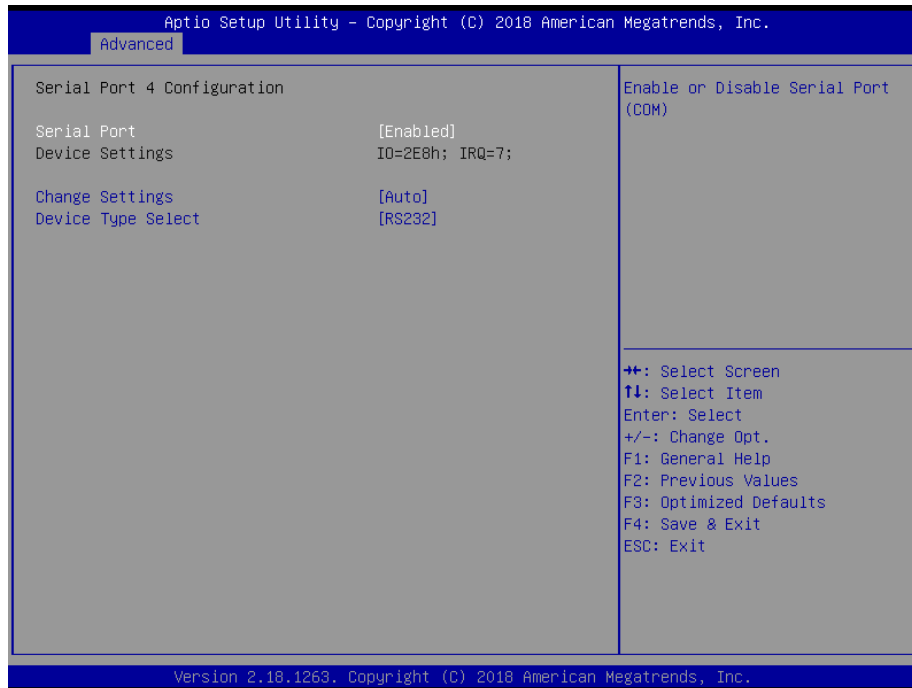

- **Serial Port**  
This item allows you to enable or disable serial port.
- **Change Settings**  
This item allows you to change the address & IRQ settings of the specified serial port.
- **Device Type Select**  
Change the Serial interface. Select <RS232>, <RS422> or <RS485> interface.

## Serial Port 5 Configuration

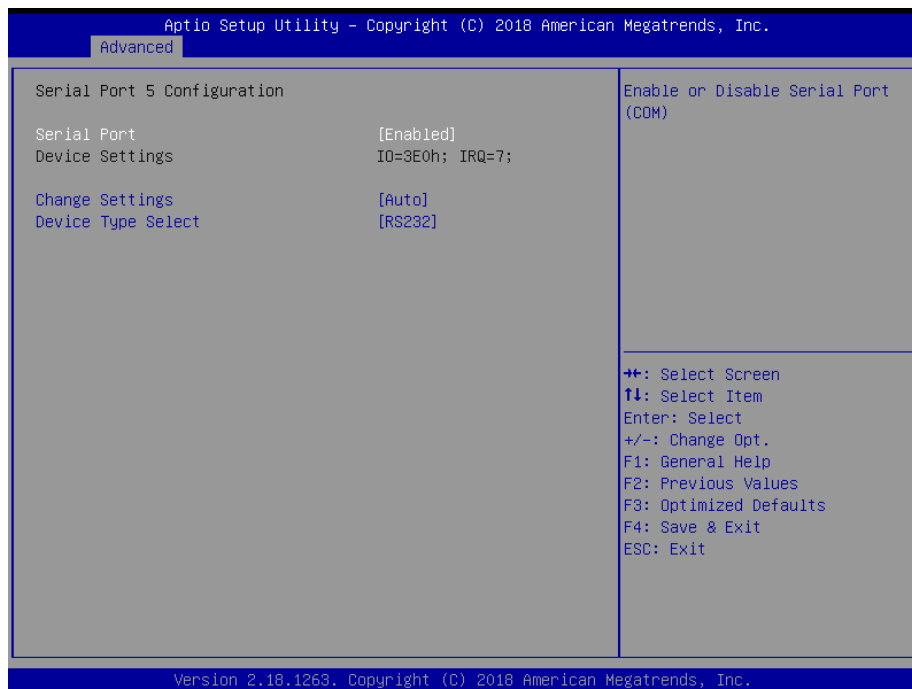

- **Serial Port**  
This item allows you to enable or disable serial port.
- **Change Settings**  
This item allows you to change the address & IRQ settings of the specified serial port.
- **Device Type Select**  
Change the Serial interface. Select <RS232>, <RS422> or <RS485> interface.

## Serial Port 6 Configuration

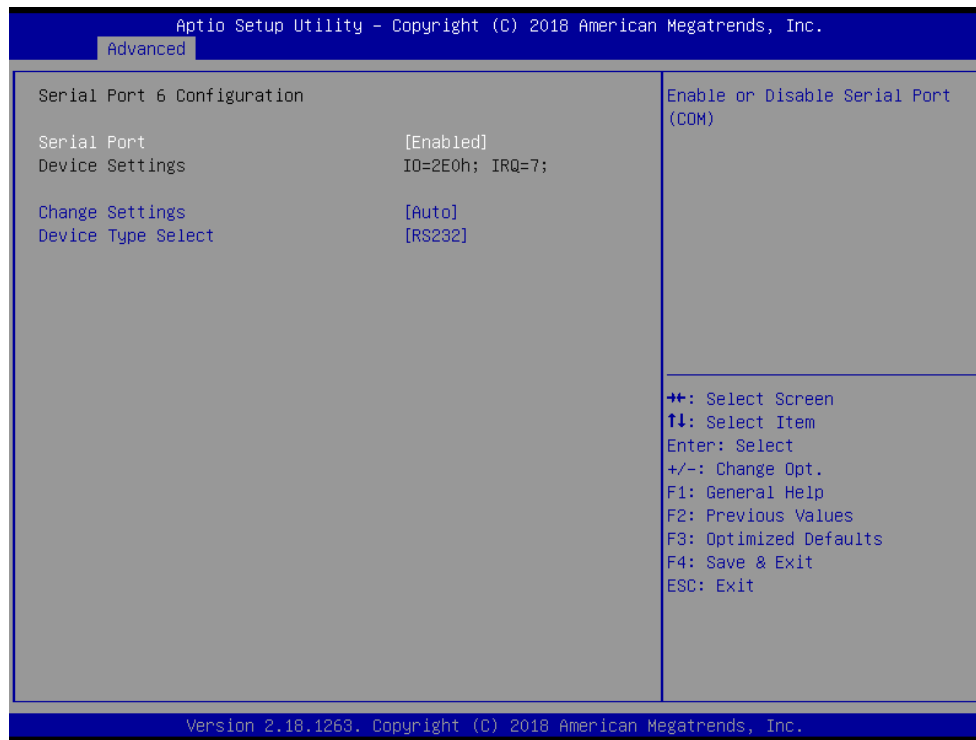

- **Serial Port**  
This item allows you to enable or disable serial port.
- **Change Settings**  
This item allows you to change the address & IRQ settings of the specified serial port.
- **Device Type Select**  
Change the Serial interface. Select <RS232>, <RS422> or <RS485> interface.

### 4.3.8 Hardware Monitor

These items display the current status of all monitored hardware devices/ components such as voltages and temperatures.

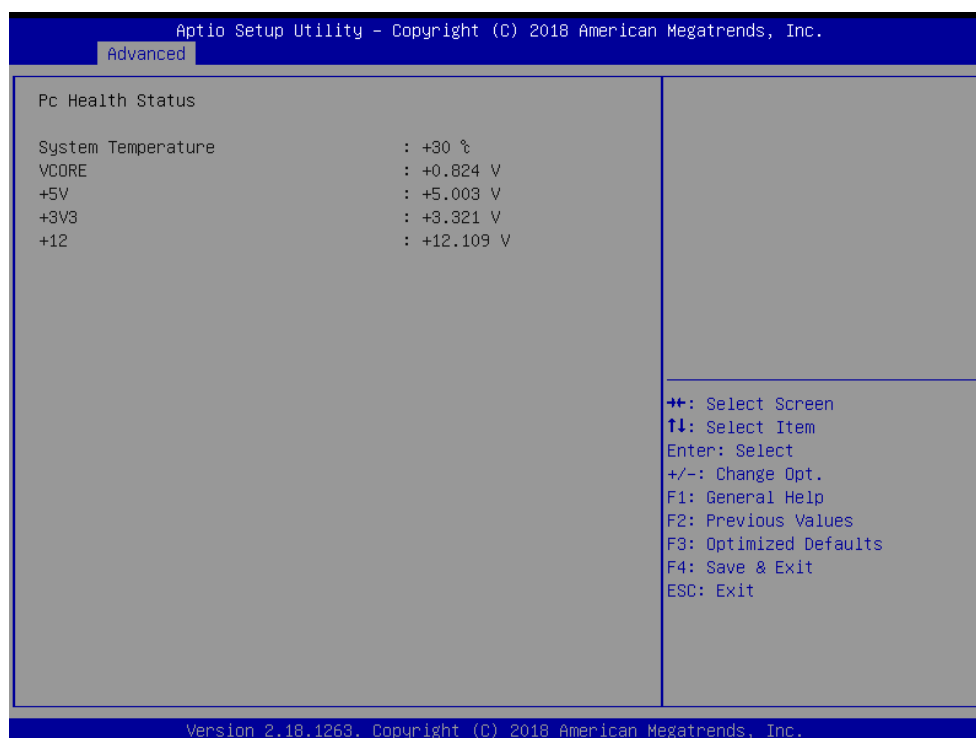

### 4.3.9 Serial Port Console Redirection

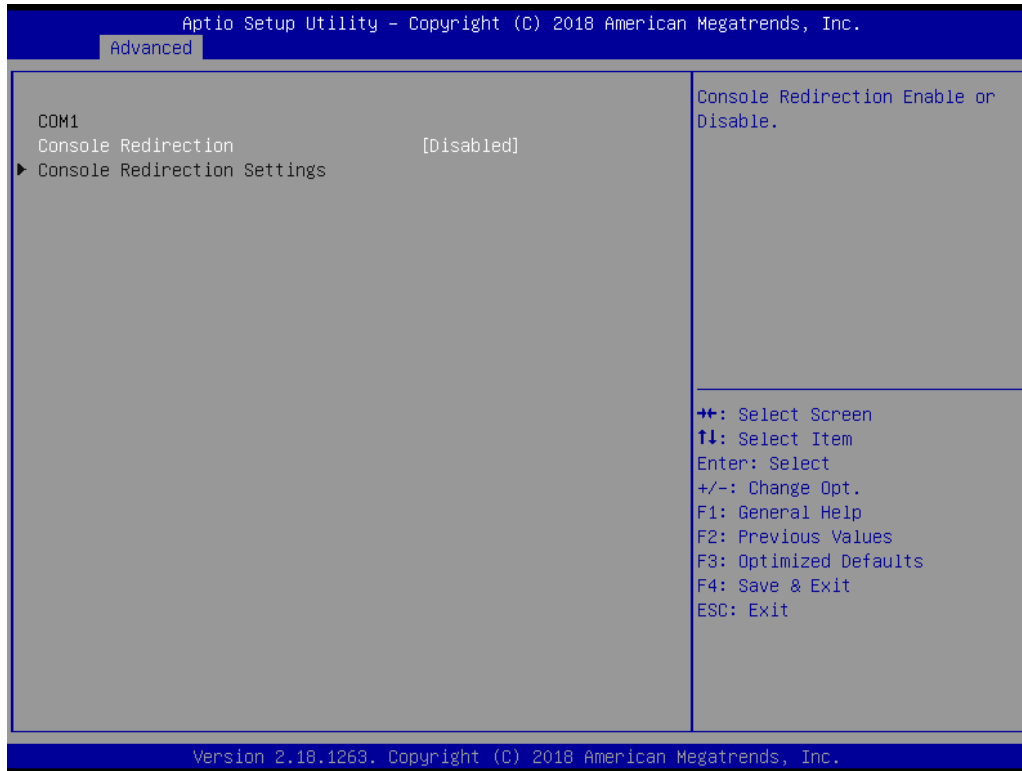

#### ■ Console Redirection

These items allow you to enable or disable COM1 console redirection.

### 4.3.10 Stack Configuration

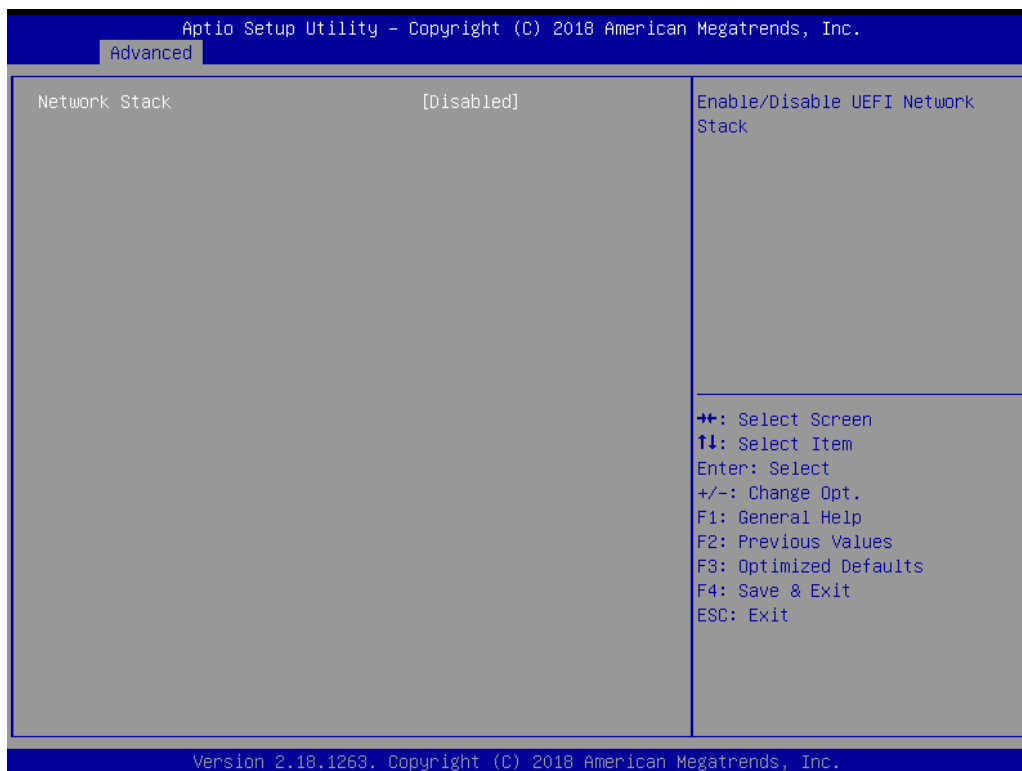

### 4.3.11 CSM Configuration

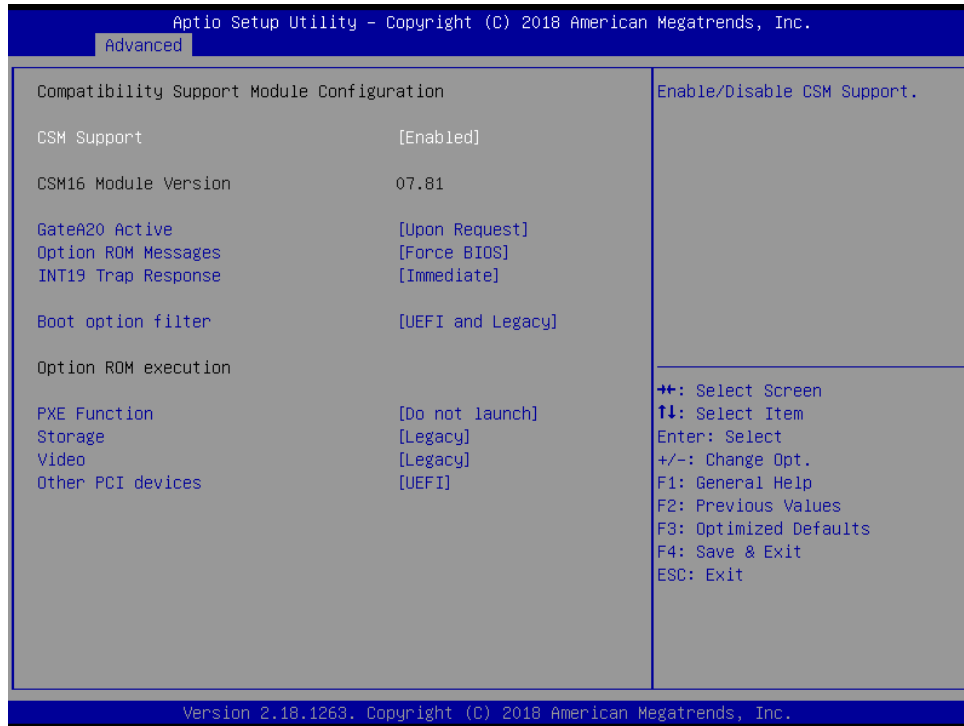

#### ■ CSM Support

This item allows users to enable or disable for “CSM Support”.

#### ■ GateA20 Active

This item allows users to set Upon Request or Always for "GateA20 Active“.

#### ■ Option ROM Messages

This item allows users to set Force BIOS or Keep Current for “Option ROM Messages”.

#### ■ INT19 Trap Response

This item allows users to set the BIOS reaction to INT19 trapping by Option ROM:  
 “Immediate” - execute the trap right away;  
 “postponed” - execute the trap during legacy boot.

#### ■ Boot option filter

This item allows users to select which type of operating system to boot by option:  
 “UEFI and Legacy” - allows booting from operating systems that support legacy option ROM or UEFI option ROM;  
 “Legacy only” - allows booting from operating systems that only support legacy option ROM;  
 “UEFI only” - allows booting from operating systems that only support UEFI option ROM.  
 This item is configurable only when CSM Support is set to Enabled.

#### ■ PXE Function

This item allows users to enable or disable PXE function.

#### ■ Storage

This item allows users to set Do not launch or UEFI or Legacy for “Storage”.

#### ■ Video

This item allows users to set Do not launch or UEFI or Legacy for “Video”.

#### ■ Other PCI devices

This item allows users to set Do not launch or UEFI or Legacy for “Other PCI devices”.

### 4.3.12 USB Configuration

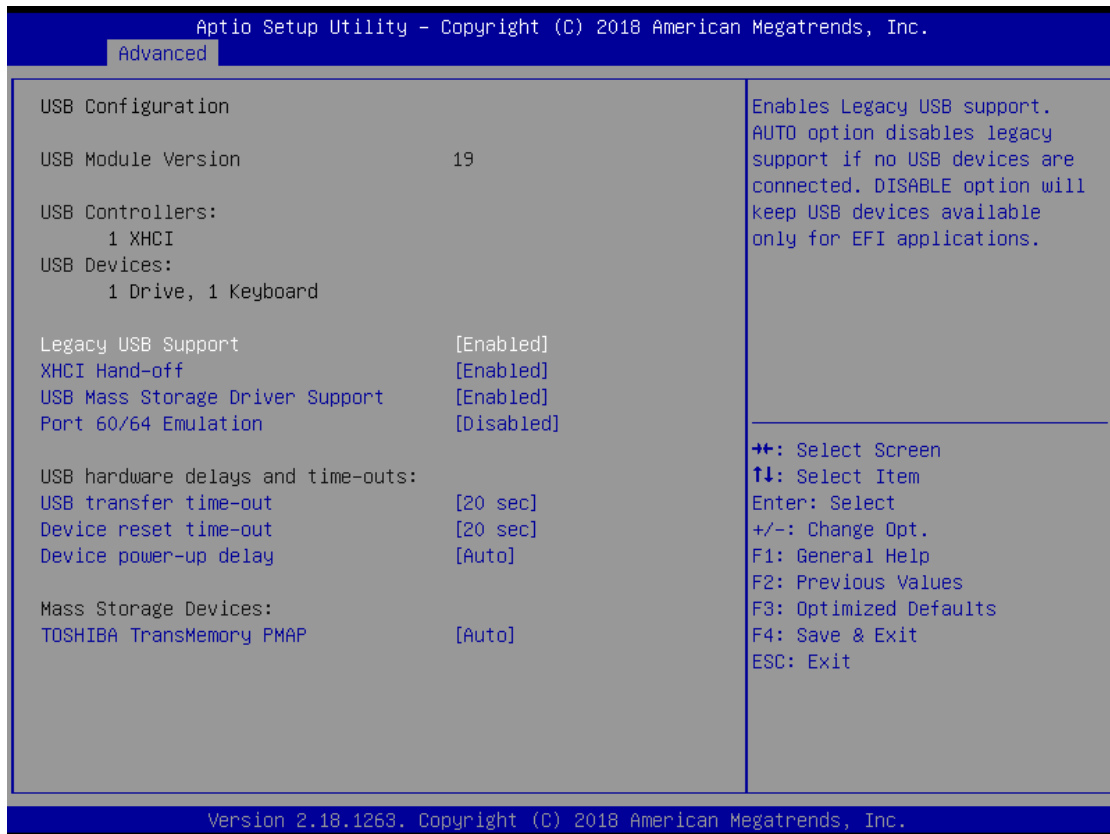

#### ■ Legacy USB Support

Allows USB keyboard/ mouse to be used in MS-DOS.

#### ■ XHCI Hand-off

Determines whether to enable XHCI (USB3.0) Hand-off feature for an operating system without XHCI (USB3.0) Hand-off support.

#### ■ USB Mass Storage Driver Support

Enables or disables support for USB storage devices.

#### ■ Port 60/64 Emulation

Enables or disables support for Port 60/64 Emulation.

#### ■ USB transfer time-out

This item allows users to set different time mode for “USB transfer time-out”.

#### ■ Device reset time-out

This item allows users to set different time mode for “Device reset time-out”.

#### ■ Device power-up delay

This item allows users to set different time mode for “Device power-up delay”.

#### ■ Mass Storage Devices

This item allows users to set different mode for “Mass Storage Devices”.

## 4.4 Chipset

This section allows you to configure and improve your system and allows you to set up some system features according to your preference.

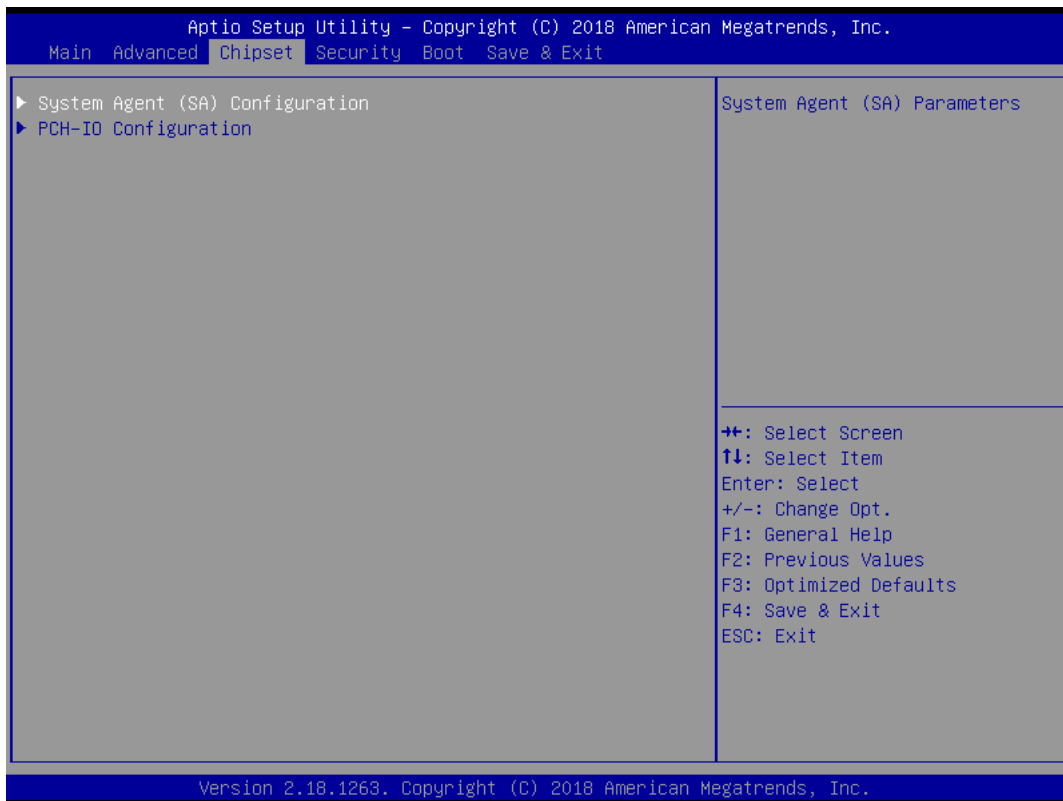

### 4.4.1 System Agent (SA) Configuration

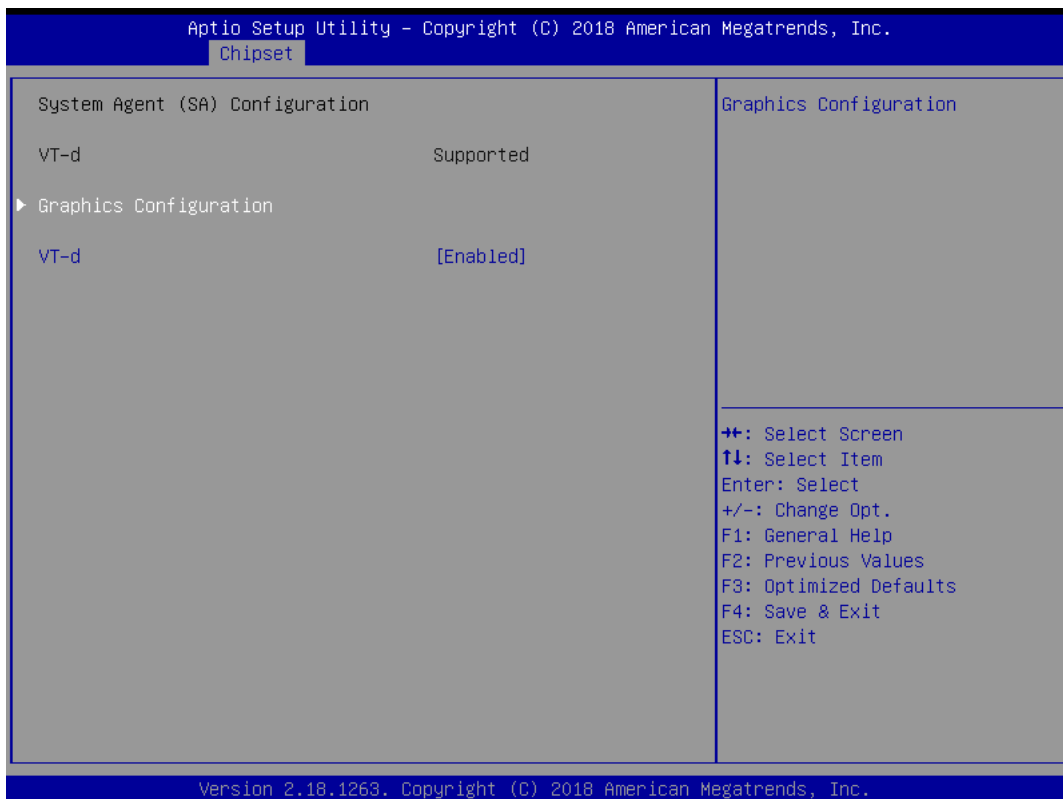

#### ■ VT-d

This item allows users to enable or disable VT-d.

## ■ Graphic Configuration

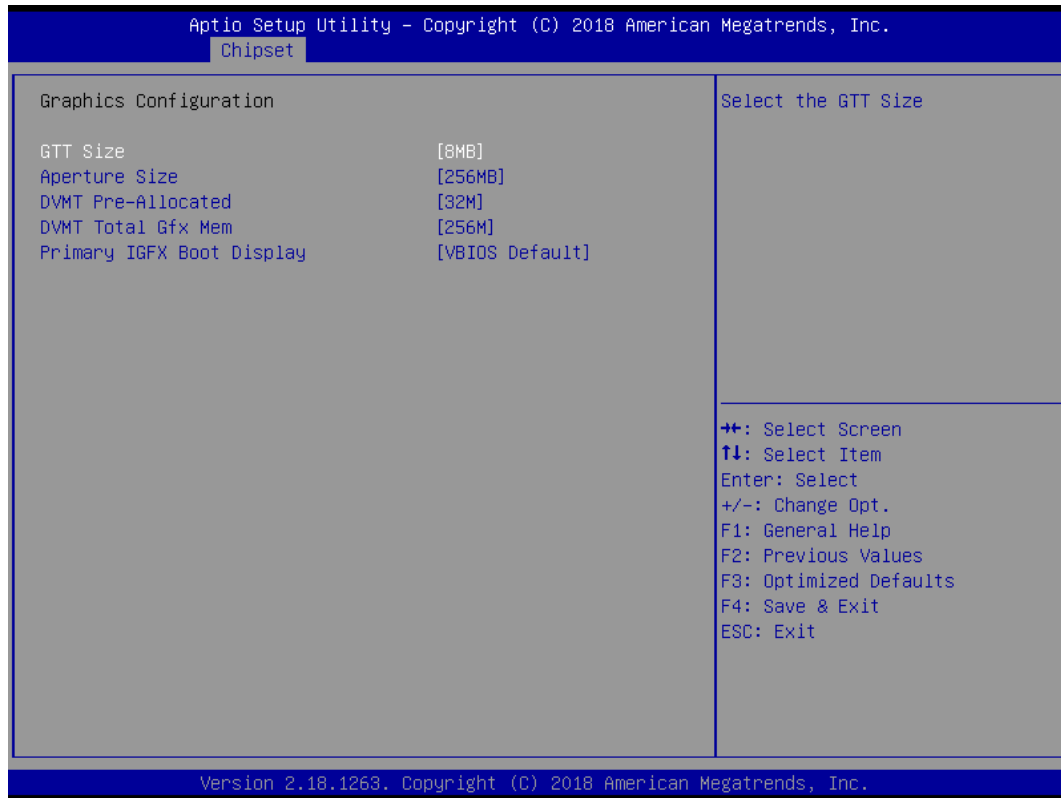

- **GTT Size**  
This item allows you to change the GTT size.
- **Aperture Size**  
Aperture size optimal between 128MB, 256MB, 512MB, 1024MB or 2048MB.
- **DVMT Pre-Allocated**  
DVMT pre-allocated (fixed) Graphics memory size optimal from 0M to 60M.
- **DVMT Total Gfx Mem**  
DVMT Total Gfx Mem optimal Between 128M, 256M or MAX.
- **Primary IGFX Boot Display**  
Use the field to select the type of device you want to use as the display(s) of the system.



## 4.4.2 PCH-IO Configuration

This section allows you to configure the chipset.

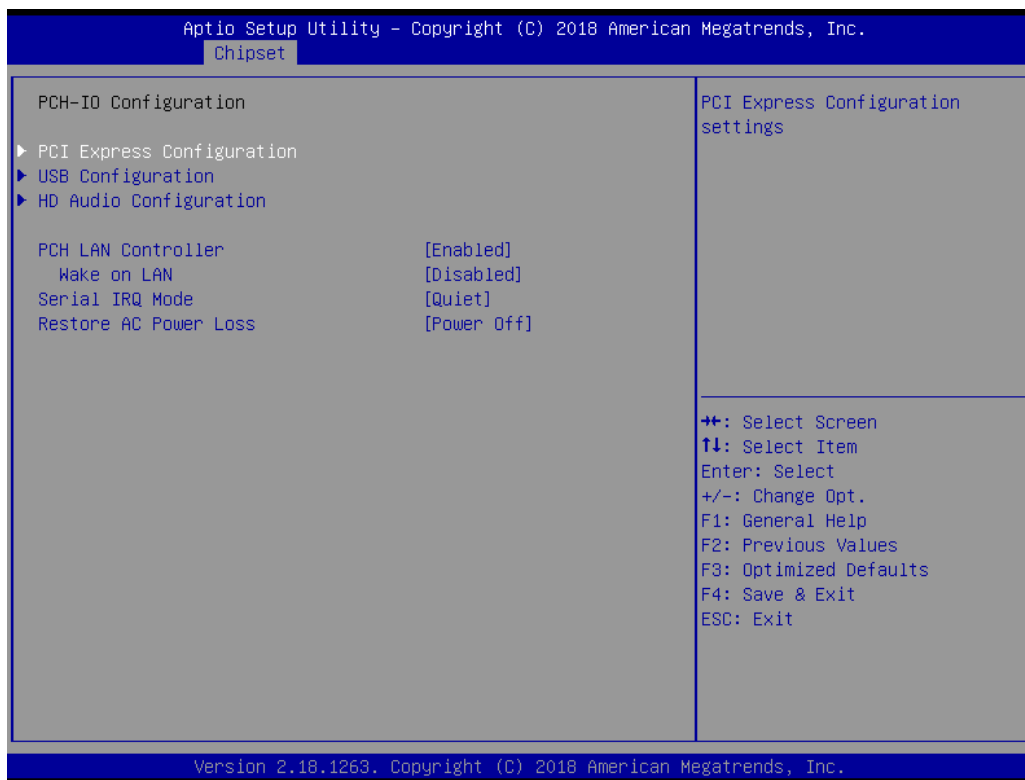

### ■ PCI Express Configuration

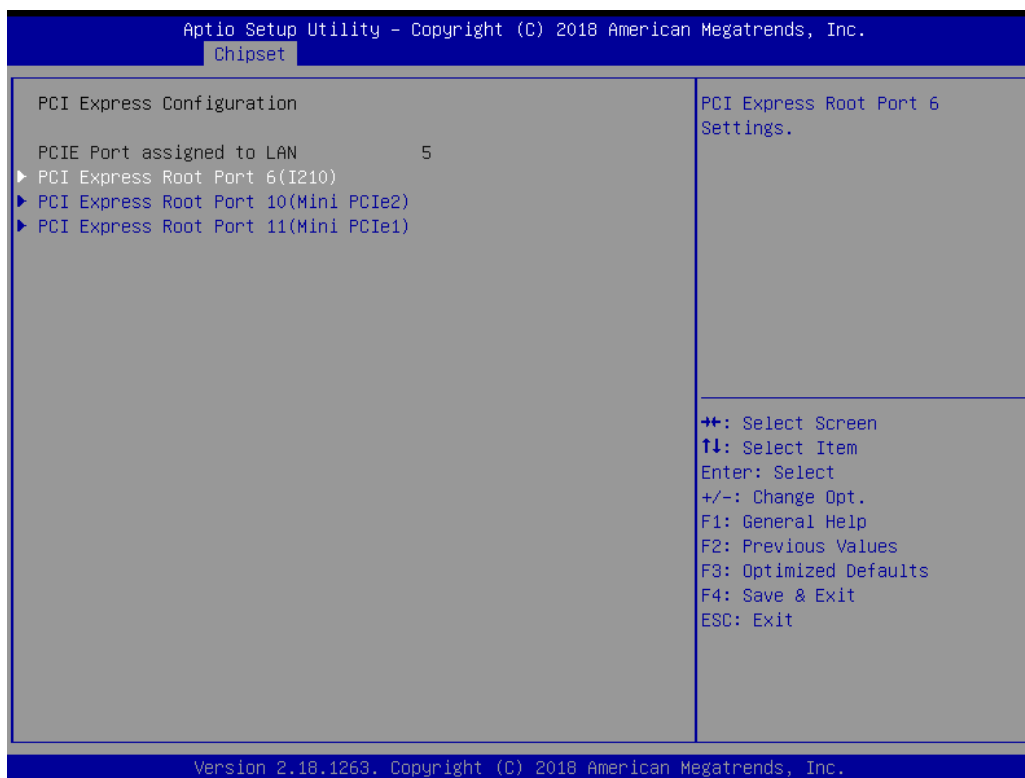

- **PCI Express Root Port 6 / 10 / 11**

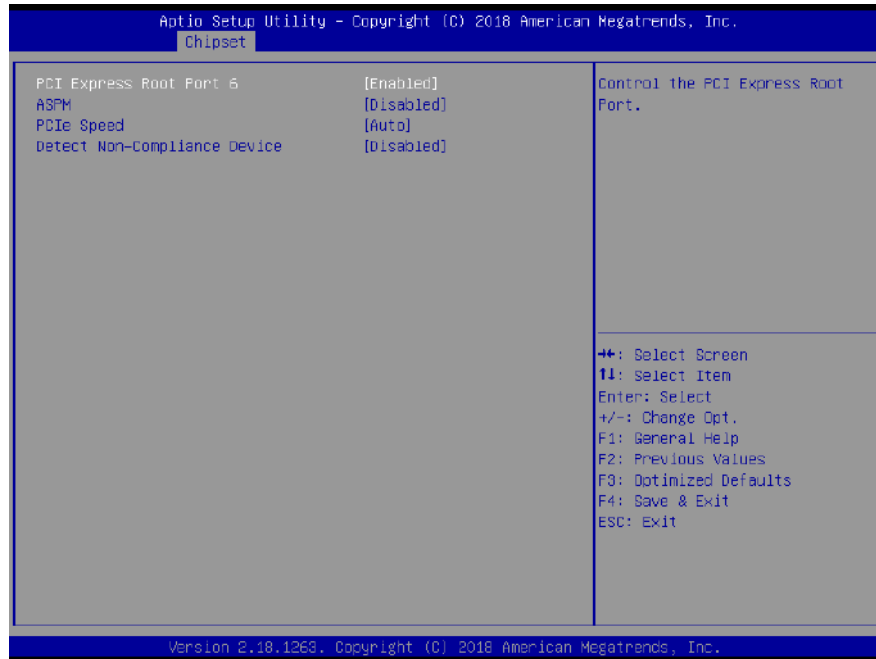

- ✓ **PCI Express Port 6 / 10 / 11**

This item allows you to enable or disable PCI Express Port 6 / 10 / 11 in the chipset.

- ✓ **ASPM**

This item allows you to select the ASPM state for energy-saving. Select <Disabled>, <L0s>, <L1>, <L0sL1> or <Auto>

- ✓ **PCIe Speed**

Change the PCIe Port Speed. Select <AUTO>, <Gen 1>, <Gen 2> or <Gen 3>

- ✓ **Detect Non-Compliance Device**

Detect Non-Compliance PCI Express Device. If enable, it will take more time at POST time.

## ■ USB Configuration

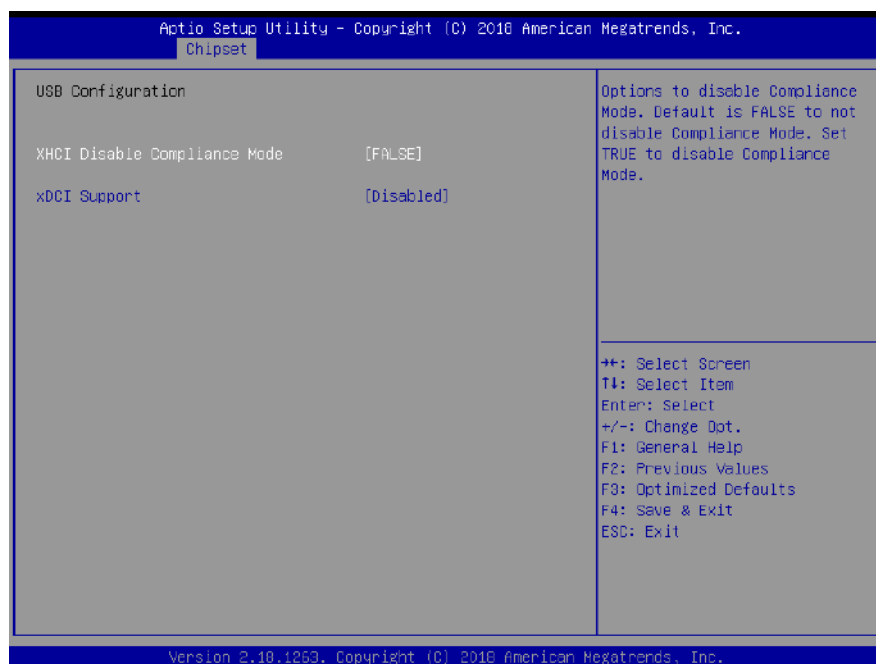

- **XHCI Disable Compliance mode**

Options to disable compliance mode. Default is FALSE enable compliance mode. Set TRUE to disable compliance mode.

- **xDCI Support**

This item will allow users to enable or disable xDCI Support.

## ■ HD Audio Configuration

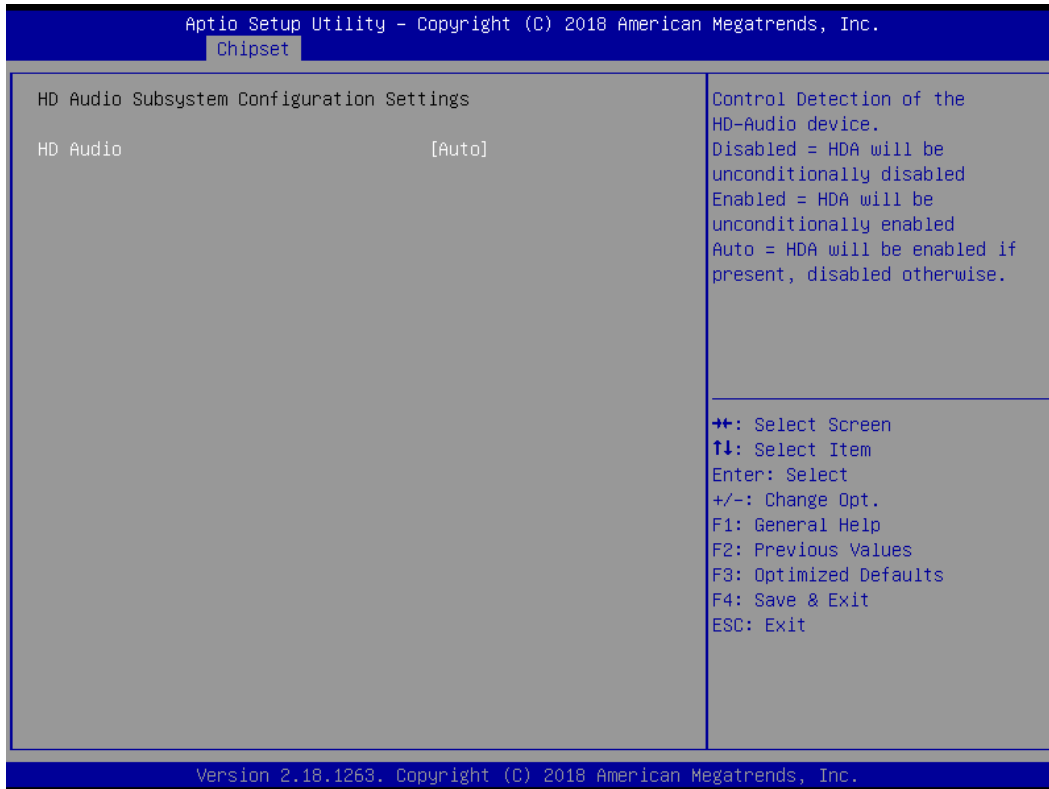

### ● HD Audio

Control detection of the HD-Audio device. This item allows you to select <Enabled>, <Disabled> or <Auto>.

Disabled: Azalia will be unconditionally be disabled.

Enabled: Azalia will be unconditionally be enabled.

Auto: Azalia will be enabled if present, disabled otherwise.

## 4.5 Security

Security menu allow users to change administrator password and user password settings.

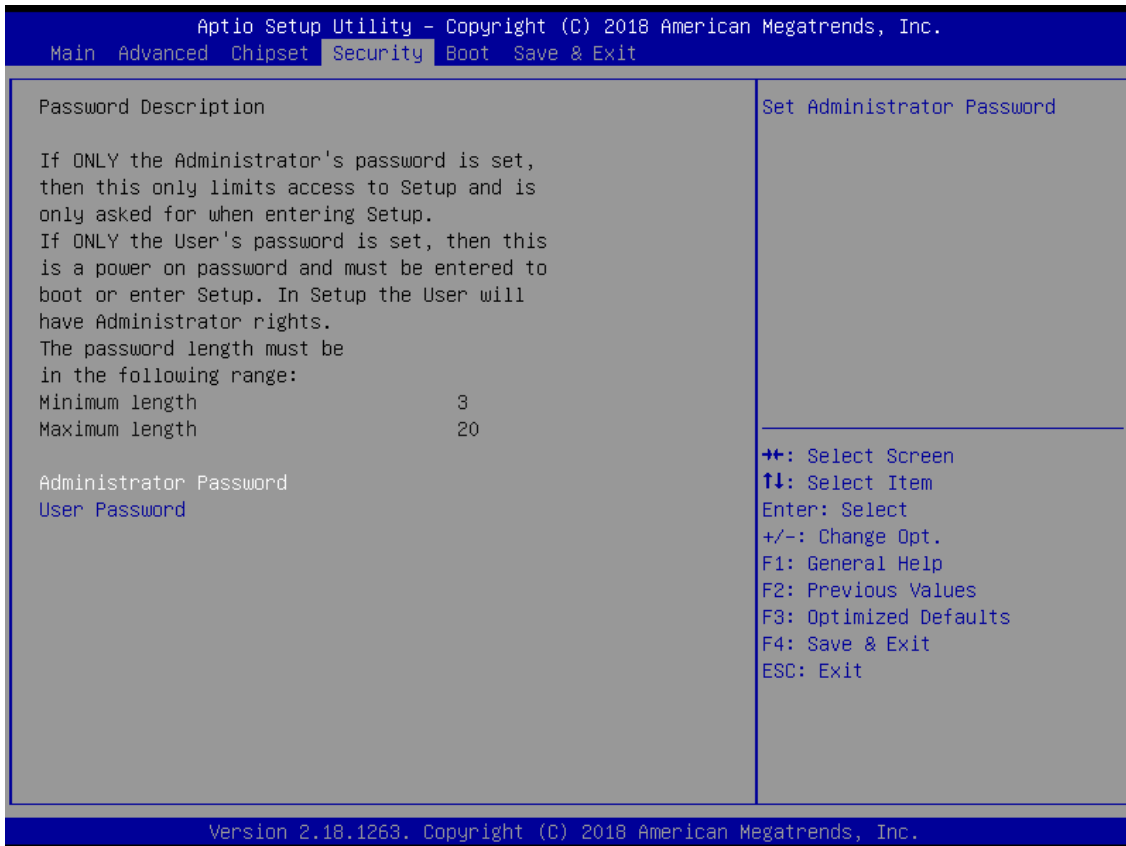

### ■ Administrator Password

This item allows you to set Administrator Password.

### ■ User Password

This item allows you to set User Password.

## 4.6 Boot

This menu allows you to setup the system boot options.

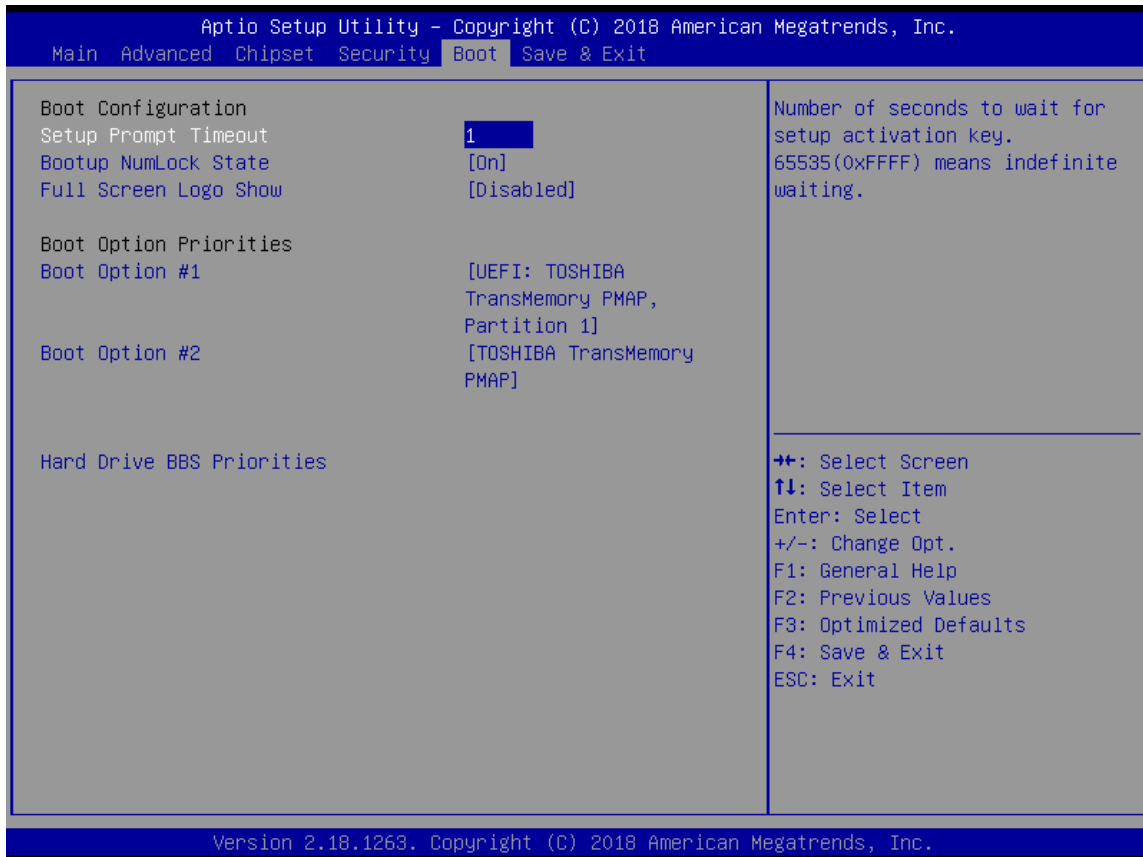

### ■ Setup Prompt Timeout

This item sets number of seconds to wait for setup activation key.

### ■ Bootup NumLock State

This item selects the keyboard NumLock state. Select <On> or <Off>.

### ■ Full Screen Logo Show

This item allows you to enable or disable Full Screen Logo Show function.

### ■ Hard Driver BBS Priorities

The items specify the boot device priority sequence from the available devices. The number of device items that appears on the screen depends on the number of devices installed in the system.

## 4.7 Save & Exit

This setting allows users to configure the boot settings.

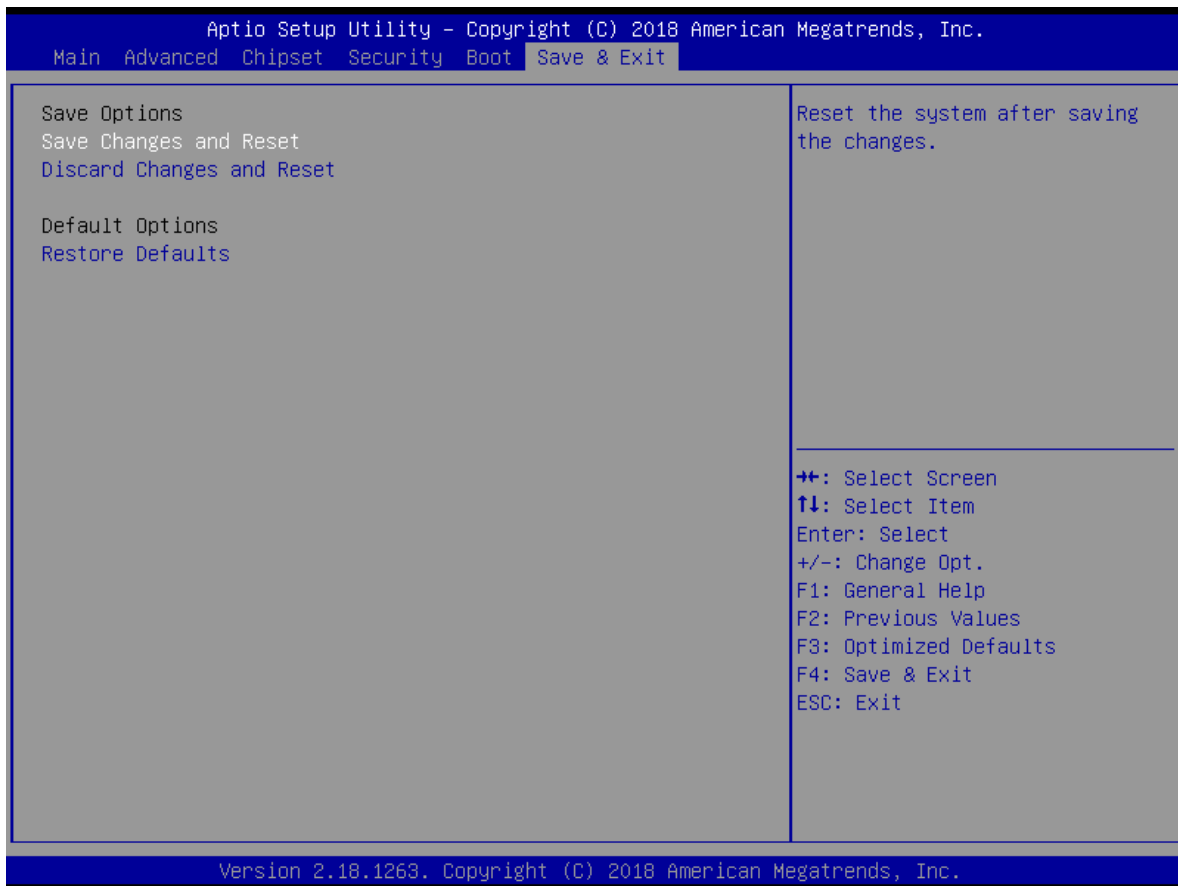

### ■ Save Changes and Reset

This item allows user to reset the system after saving the changes. This item allows user to reset the system after saving the changes.

### ■ Discard Changes and Reset

This item allows user to reset the system without saving any changes.

### ■ Restore Defaults

Use this item to restore /load default values for all the setup options.

# Appendix

## WDT & GPIO

This appendix provides the sample codes of WDT (Watch Dog Timer) and GPIO (General Purpose Input/ Output).

## WDT Sample Code

```
// IO Address 0xA16 is time value
// IO Address 0xA15 is WDT enable and configuration
Example, Set 0xA16=0x03, 0xA15=0x31, it will reset after 3 seconds
```

```
#define TimePort    0xA16
#define TimeEnablePort 0xA15

WriteByte (TimePort,0x03)
WriteByte (TimeEnablePort,0x31)
```

### Watchdog Timer Configuration Register 1 – base address + 05h

Bit	Name	R/W	Reset	Default	Description
7	Reserved	R	-	0	Reserved
6	WDTMOUT_STS	R/W	5VSB	0	If watchdog timeout event occurred, this bit will be set to 1. Write a 1 to this bit will clear it to 0.
5	WD_EN	R/W	5VSB	0	If this bit is set to 1, the counting of watchdog time is enabled.
4	WD_PULSE	R/W	5VSB	0	Select output mode (0: level, 1: pulse) of RSTOUT# by setting this bit.
3	WD_UNIT	R/W	5VSB	0	Select time unit (0: 1 sec, 1: 60 sec) of watchdog timer by setting this bit.
2	WD_HACTIVE	R/W	5VSB	0	Select output polarity of RSTOUT# (1: high active, 0: low active) by setting this bit.
1-0	WD_PSWIDTH	R/W	5VSB	0	Select output pulse width of RSTOUT# 0: 1 ms      1: 25 ms 2: 125 ms    3: 5 sec

### Watchdog Timer Configuration Register 2 – base address + 06h

Bit	Name	R/W	Reset	Default	Description
7-0	WD_TIME	R/W	5VSB	0	Time of watchdog timer



## GPIO Sample Code

- GPI 1 ~ GPI 8

	GPI 1	GPI 2	GPI 3	GPI 4	GPI 5	GPI 6	GPI 7	GPI 8
IO Address	0xA03h	0xA03h	0xA03h	0xA03h	0xA06h	0xA06h	0xA06h	0xA06h
Bit	4	5	6	7	0	1	2	3
Sample code	#1							

- GPO 1 ~ GPO 8

	GPO 1	GPO 2	GPO 3	GPO 4	GPO 5	GPO 6	GPO 7	GPO 8
IO Address	0xA02h	0xA02h	0xA02h	0xA02h	0xA06h	0xA07h	0xA08h	0xA04h
Bit	0	1	2	3	4	7	0	7
Sample code	#2							

```

#define GPI1to4_ADDR      0xA03
#define GPI5to8_ADDR     0xA06

#define GPO1to4_ADDR     0xA02

#define GPO5_ADDR        0xA06
#define GPO6_ADDR        0xA07
#define GPO7_ADDR        0xA08
#define GPO8_ADDR        0xA04

#define GPO1_DataHigh    0x01
#define GPO2_DataHigh    0x02
#define GPO3_DataHigh    0x04
#define GPO4_DataHigh    0x08
#define GPO5_DataHigh    0x10
#define GPO6_DataHigh    0x80
#define GPO7_DataHigh    0x01
#define GPO8_DataHigh    0x80

#define WriteByte        outputb
#define ReadByte         inportb

```

Sample Code:

```
#1 :
// Get GPI 1 status
//Get GPI 0 Pin Status Register
printf("Input port value = %x\n", ReadByte(GPI1to4_ADDR)); // bit4 = GPI 1 status

// Get GPI 5 status
//Get GPI 0 Pin Status Register
printf("Input port value = %x\n", ReadByte(GPI_REG5to8)); // bit0 = GPI 5 status

#2 :
// Set GPO status to high
; Set GPO 1 Pin to High
Data = ReadByte(GPO1to4_ADDR) | GPO1_DataHigh;
WriteByte(GPO1to4_ADDR, Data); //Set IO_DO1 to High

; Set GPO 2 Pin to High
Data = ReadByte(GPO1to4_ADDR) | GPO2_DataHigh;
WriteByte(GPO1to4_ADDR, Data); //Set IO_DO2 to High

; Set GPO 3 Pin to High
Data = ReadByte(GPO1to4_ADDR) | GPO3_DataHigh;
WriteByte(GPO1to4_ADDR, Data); //Set IO_DO3 to High

; Set GPO 4 Pin to High
Data = ReadByte(GPO1to4_ADDR) | GPO4_DataHigh;
WriteByte(GPO1to4_ADDR, Data); //Set IO_DO4 to High

; Set GPO 5 Pin to High
Data = ReadByte(GPO5_ADDR) | GPO5_DataHigh;
WriteByte(GPO5_ADDR, Data); //Set IO_DO5 to High

; Set GPO 6 Pin to High
Data = ReadByte(GPO6_ADDR) | GPO6_DataHigh;
WriteByte(GPO6_ADDR, Data); //Set IO_DO6 to High

; Set GPO 7 Pin to High
Data = ReadByte(GPO7_ADDR) | GPO7_DataHigh;
WriteByte(GPO7_ADDR, Data); //Set IO_DO7 to High

; Set GPO 8 Pin to High
Data = ReadByte(GPO8_ADDR) | GPO8_DataHigh;
WriteByte(GPO8_ADDR, Data); //Set IO_DO8 to High
```

