

# USER'S MANUAL

## RCO-1000-EHL Series Compact Fanless Embedded System



# Table of Contents

<b>Prefaces .....</b>	<b>04</b>
Revision .....	04
Disclaimer .....	04
Copyright Notice .....	04
Trademarks Acknowledgment .....	04
Environmental Protection Announcement .....	04
Safety Precautions .....	05
Technical Support and Assistance .....	06
Conventions Used in this Manual .....	06
Package Contents .....	07
Ordering Information .....	07
Optional Accessory .....	08
<b>Chapter 1 Product Introductions .....</b>	<b>09</b>
1.1 Overview .....	10
1.1.1 Key Feature .....	11
1.2 Hardware Specification .....	12
1.3 System I/O .....	14
1.3.1 RCO-1000-EHL-10 .....	14
1.3.2 RCO-1000-EHL-20 .....	16
1.3.3 RCO-1000-EHL-30 .....	18
1.4 Mechanical Dimension .....	18
1.4.1 RCO-1000-EHL-10 .....	20
1.4.2 RCO-1000-EHL-20 .....	21
1.4.3 RCO-1000-EHL-30 .....	22
<b>Chapter 2 Switches and Connectors .....</b>	<b>23</b>
2.1 Switch and connector Locations .....	24
2.1.1 Top View .....	24
2.1.2 Bottom View .....	25
2.1.3 Daughterboard view .....	26
2.2 Connector / Switch Definition .....	27
2.3 Switch Definitions .....	28
<b>Chapter 3 System Setup .....</b>	<b>41</b>
3.1 Set torque force to 3.5 kgf-cm to execute all the screwing and unscrewing .....	42
3.2 Removing chassis bottom cover .....	42
3.3 Removing HDD bracket .....	43
3.4 Removing chassis top cover .....	44
3.5 Installing SODIMM .....	45
3.6 Installing Mini PCIe card / mSATA .....	46
3.7 Installing antenna .....	47
3.8 Assemble chassis top cover .....	49
3.9 Installing SATA HDD .....	51
3.10 Assemble chassis bottom cover .....	53
3.11 Installing SIM card .....	54

3.12	Installing wall mount kit .....	56
3.13	Installing VESA mount kit .....	58
3.14	Installing side mount kit .....	60
3.15	Installing DIN rail holder .....	62
<b>Chapter 4</b>	<b>BIOS Setup .....</b>	<b>63</b>
4.1	BIOS Introduction .....	64
4.2	Main Setup .....	65
4.3	Advanced Setup .....	66
4.3.1	CPU Configuration .....	67
4.3.2	PCH-FW Configuration .....	68
4.3.3	SATA and RST Configuration .....	69
4.3.4	Trusted Computing .....	70
4.3.5	ACPI Settings .....	71
4.3.6	Super IO Configuration .....	72
4.3.7	Hardware Monitor .....	79
4.3.8	Power IGN Mode .....	81
4.3.9	Serial Port Console Redirection .....	82
4.3.10	USB Configuration .....	83
4.3.11	Network Stack Configuration .....	84
4.4	Chipset .....	85
4.4.1	System Agent (SA) Configuration .....	86
4.4.2	PCH-IO Configuration .....	89
4.5	Security .....	94
4.6	Boot .....	97
4.7	Save & Exit .....	98
<b>Appendix WDT &amp; GPIO</b>	<b>.....</b>	<b>99</b>
	WDT Sample Code .....	100
	GPIO Sample Code .....	101

## Prefaces

### Revision

Revision	Description	Date
1.0	Manual Released	2022/11/22

### Disclaimer

All specifications and information in this User's Manual are believed to be accurate and up to date. C&T Solution Inc. does not guarantee that the contents herein are complete, true, accurate or non-misleading. The information in this document is subject to change without notice and does not represent a commitment on the part of C&T Solution Inc.

C&T Solution Inc. disclaims all warranties, express or implied, including, without limitation, those of merchantability, fitness for a particular purpose with respect to contents of this User's Manual. Users must take full responsibility for the application of the product.

### Copyright Notice

All rights reserved. No part of this manual may be reproduced or transmitted in any form or by any means, electronic or mechanical, including photocopying, recording, or information storage and retrieval systems, without the prior written permission of C&T Solution Inc. Copyright © C&T Solution Inc.

### Trademarks Acknowledgment

Intel®, Celeron® and Pentium® are trademarks of Intel Corporation.

Windows® is registered trademark of Microsoft Corporation.

AMI is trademark of American Megatrend Inc.

IBM, XT, AT, PS/2 and Personal System/2 are trademarks of International Business Machines Corporation

All other products and trademarks mentioned in this manual are trademarks of their respective owners.

### Environmental Protection Announcement

Do not dispose this electronic device into the trash while discarding. Please recycle to minimize pollution and ensure environment protection.

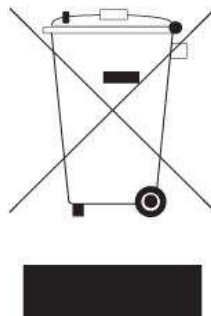

## Safety Precautions

Before installing and using the equipment, please read the following precautions:

- Put this equipment on a reliable surface during installation. Dropping it or letting it fall could cause damage.
- The power outlet shall be installed near the equipment and shall be easily accessible.
- Turn off the system power and disconnect the power cord from its source before making any installation. Be sure both the system and the external devices are turned OFF. Sudden surge
- of power could ruin sensitive components. Make sure the equipment is properly grounded.
- When the power is connected, never open the equipment. The equipment should be opened only by qualified service personnel.
- Make sure the voltage of the power source is correct before connecting the equipment to the power outlet.
- Disconnect this equipment from the power before cleaning. Use a damp cloth. Do not use liquid or spray detergents for cleaning.
- Avoid the dusty, humidity and temperature extremes.
- Do not place heavy objects on the equipment.
- If the equipment is not used for long time, disconnect it from the power to avoid being damaged by transient over-voltage.
- The storage temperature shall be above  $-40^{\circ}\text{C}$  and below  $85^{\circ}\text{C}$ .
- The computer is provided with a battery-powered real-time clock circuit. There is a danger of explosion if incorrectly replaced. Replace only with the same or equivalent type recommended by the manufacturer.
- If one of the following situation arises, get the equipment checked by service personnel:
  - The power cord or plug is damaged.
  - Liquid has penetrated into the equipment.
  - The equipment has been exposed to moisture.
  - The equipment does not work well or it cannot work according the user's manual.
  - The equipment has been dropped and damaged.
  - The equipment has obvious signs of breakage.

## Technical Support and Assistance

1. Visit the C&T Solution Inc website at <https://www.candtsolution.com> where you can find the latest information about the product.
2. Contact your distributor, our technical support team or sales representative for technical support if you need additional assistance. Please have following information ready before you call:
  - Model name and serial number
  - Description of your peripheral attachments
  - Description of your software (operating system, version, application software, etc.)
  - A complete description of the problem
  - The exact wording of any error messages

## Conventions Used in this Manual

**WARNING**

This indication alerts operators to an operation that, if not strictly observed, may result in severe injury.

**CAUTION**

This indication alerts operators to an operation that, if not strictly observed, may result in safety hazards to personnel or damage to equipment.

**NOTE**

This indication provides additional information to complete a task easily.

## Package Contents

Before installation, please ensure all the items listed in the following table are included in the package.

Item	Description	Q'ty
1	RCO-1000-EHL Series Embedded System	1
2	Wall Mount KIT	1
3	Accessory Kit	1

## Ordering Information

- RCO-1000-EHL-10 Series

Model No.	Product Description
RCO-1000-EHL-X6425E-10	Compact fanless embedded system with Intel x6425E CPU, 2x DP, 2x COM, 1x 2.5" SATA HDD Bay
RCO-1000-EHL-X6425E-10A	Compact fanless embedded system with Intel x6425E CPU, 3x DP, 2x COM, DIO, 1x 2.5" SATA HDD Bay
RCO-1000-EHL-X6425E-10B	Compact fanless embedded system with Intel x6425E CPU, 2x DP, 4x COM, 1x 2.5" SATA HDD Bay
RCO-1000-EHL-X6425E-10U	Compact fanless embedded system with Intel x6425E CPU, 2x DP, 2x COM, 4x USB, 1x 2.5" SATA HDD Bay
RCO-1000-EHL-X6425E-10H	Compact fanless embedded system with Intel x6425E CPU, 2x DP, 1x HDMI, 2x COM, DIO, 1x 2.5" SATA HDD Bay
RCO-1000-EHL-X6425E-10G	Compact fanless embedded system with Intel x6425E CPU, 2x DP, 2x COM, 1x 2.5" SATA HDD Bay, Power Ignition
RCO-1000-EHL-J6413-10	Compact fanless embedded system with Intel J6413 CPU, 2x DP, 2x COM, 1x 2.5" SATA HDD Bay
RCO-1000-EHL-J6413-10A	Compact fanless embedded system with Intel J6413 CPU, 3x DP, 2x COM, DIO, 1x 2.5" SATA HDD Bay
RCO-1000-EHL-J6413-10B	Compact fanless embedded system with Intel J6413 CPU, 2x DP, 4x COM, 1x 2.5" SATA HDD Bay
RCO-1000-EHL-J6413-10U	Compact fanless embedded system with Intel J6413 CPU, 2x DP, 2x COM, 4x USB, 1x 2.5" SATA HDD Bay
RCO-1000-EHL-J6413-10H	Compact fanless embedded system with Intel J6413 CPU, 2x DP, 1x HDMI, 2x COM, DIO, 1x 2.5" SATA HDD Bay
RCO-1000-EHL-J6413-10G	Compact fanless embedded system with Intel J6413 CPU, 2x DP, 2x COM, 1x 2.5" SATA HDD Bay, Power Ignition

- **RCO-1000-EHL-20 Series**

Model No.	Product Description
RCO-1000-EHL-X6425E-20C	Compact fanless embedded system with Intel x6425E CPU, 3x DP, 2x COM, DIO, 1x 2.5" SATA HDD Bay
RCO-1000-EHL-X6425E-20D	Compact fanless embedded system with Intel x6425E CPU, 2x DP, 4x COM, 1x 2.5" SATA HDD Bay
RCO-1000-EHL-J6413-20C	Compact fanless embedded system with Intel J6413 CPU, 3x DP, 2x COM, DIO, 1x 2.5" SATA HDD Bay
RCO-1000-EHL-J6413-20D	Compact fanless embedded system with Intel J6413 CPU, 2x DP, 4x COM, 1x 2.5" SATA HDD Bay

- **RCO-1000-EHL-30 Series**

Model No.	Product Description
RCO-1000-EHL-X6425E-30C	Compact fanless embedded system with Intel x6425E CPU, 3x DP, 2x COM, DIO, 1x 2.5" SATA HDD Bay
RCO-1000-EHL-J6413-30C	Compact fanless embedded system with Intel J6413 CPU, 3x DP, 2x COM, DIO, 1x 2.5" SATA HDD Bay

## Optional Accessories

Model No.	Product Description
1-E09A06008	Adapter AC/DC 12V 5A 60W with 3pin Terminal Block Plug 5.0mm Pitch
SFICBL022	Power Cord, 3-pin US Type, 180cm
1-TPCD00002	Power Cord, European Type, 180cm
1-TPCD00001	Power Cord, 3-pin UK Type, 180cm
3-SIDE-0002	RCO-1000-EHL-10 Series Side Mount Kit
3-SIDE-0003	RCO-1000-EHL-20 Series Side Mount Kit
3-SIDE-0004	RCO-1000-EHL-30 Series Side Mount Kit
3-VESA-0003	RCO-1000 Series VESA Mount Kit
3-DINR-0004	DIN-Rail-2 Mount Kit



## Chapter 1

# Product Introductions

## 1.1 Overview

Based on Intel® Atom™ x6425E (2.0GHz) Quad Core processor or Celeron® J6413 (1.8GHz) Quad Core processor, RCO-1000-EHL series is a high variety and diversity fanless embedded system. It offers modularize expansion I/O, rich connectivity interfaces, wide range (9~36V) DC power input, and high reliability even operating in temperature extremes (-40 °C up to 70 °C).

Featuring with completely cable-less designed, high functional, one-piece housing design, and anti-vibration, RCO-1000-EHL series are ruggedized systems that can operate in harsh environments and easy to install and maintain. A build in over voltage protection (OVP), over current protection (OCP), reserve voltage protection, and wide range DC power input makes RCO-1000-EHL series are safety system for all industrial applications.











- RCO-1000-EHL-10
- RCO-1000-EHL-10A
- RCO-1000-EHL-10B
- RCO-1000-EHL-10U
- RCO-1000-EHL-10H
- RCO-1000-EHL-10G

- RCO-1000-EHL-20
- RCO-1000-EHL-20C
- RCO-1000-EHL-20D

- RCO-1000-EHL-30C

Model No.	Rear Panel	Front Panel
RCO-1000-EHL-10		
RCO-1000-EHL-10A Expansion Modules: 1x DP Port and 1x DIO (4in/4out, Isolated)		
RCO-1000-EHL-10B Expansion Modules: 2x COM Ports		
RCO-1000-EHL-10U Expansion Modules: 4x USB Ports		
RCO-1000-EHL-10H Expansion Modules: 1x HDMI Port		
RCO-1000-EHL-10G (Power Ignition)		

Model No.	Rear Panel	Front Panel
RCO-1000-EHL-20		
RCO-1000-EHL-20C Expansion Modules: 2x COM Ports, 1x DP Port and 1x DIO (4in/4out, Isolated)		
RCO-1000-EHL-20D Expansion Modules: 4x COM Ports		
Model No.	Rear Panel	Front Panel
RCO-1000-EHL-30C Expansion Modules: 4x COM Ports, 1x DP Port and 1x DIO (4in/4out, Isolated)		

### 1.1.1 Key Features

- Support Intel Atom™/Celeron® Processor
- 1x 260-pin DDR4 SODIMM. Max. up to 32GB
- Dual Independent Display by 2x Display Port
- 2x Intel® GbE supporting Wake-on-LAN and PXE
- 1x 2.5" SATA HDD Bay, 1x mSATA,
- 1x M.2 (B Key, 2242/3042/3052, Support 4G/5G)
- 1x Full-size mini PCIe for communication or expansion modules
- 2x RS-232/422/485, 3x USB 3.2 Gen2, 1x USB 2.0
- 9 to 36VDC Wide Range Power Input Supporting AT/ATX Mode
- Wide Operating Temperature -40°C up to 70°C
- TPM 2.0 Supported
- Up to 5x Universal Expansion Slots
- UL Listed

## 1.2 Hardware Specification

System		Display	
Processor <b>Supports 11th Gen Intel® Celeron® / Atom® Processors X Series (Elkhart Lake)</b> <ul style="list-style-type: none"> <li><b>Intel PC Client Series:</b> Intel® Celeron® Processor J6413, Quad Core, 1.5 MB Cache, 1.8 GHz, 10W TDP</li> <li><b>Intel® Embedded Series:</b> Intel® Atom® Processor x6425E, Quad Core, 1.5 MB Cache, 1.8 GHz, 12W TDP</li> </ul>		DisplayPort	2x DisplayPort 1.4, DP++ (4096 x 2160@60Hz)
		Multiple Display	Dual Display
Storage			
		SSD/HDD	1x Internal 2.5" SATA HDD Bay (support H=9.5 mm)
		mSATA	1x mSATA (shared by 1x Mini PCI Express)
		M.2	1x M.2 (B Key, 2242/3042/3052, PCIe 1 + USB 3.2 Gen2, Support 4G/5G Module)
		SIM Socket	2x External SIM socket
Operating System			
		Windows	Windows 10
		Linux	Linux kernel
Expansion			
		Mini PCI Express	1x Full-size Mini PCIe
		Expansion Modules	Optional: <ul style="list-style-type: none"> <li>2-port COM module with Super I/O Chipset</li> <li>4-Port USB module with USB hub</li> <li>1-Port DP 1.4 and DIO (4 in / 4 out, Isolated)</li> <li>1-Port HDMI 2.0</li> </ul>
System Chipset		SoC integrated	
LAN Chipset		<ul style="list-style-type: none"> <li>1 GbE1: Intel I210 (Support Wake-on-LAN and PXE)</li> <li>2.5 GbE2: Intel I225 (Support Wake-on-LAN and PXE)</li> </ul>	
Audio Codec		Realtek ALC888S	
System Memory		1x 260-Pin DDR4 2400/2667/3200MT/s SODIMM. Max. up to 32GB	
Graphics		Intel® UHD Graphics	
BIOS		AMI 256Mbit SPI BIOS	
Watchdog		Software Programmable Supports 1~255 sec. System Reset	
TPM		TPM 2.0	

I/O	
COM	2x RS-232/422/485
USB	3x USB 3.2 Gen 2 (10 Gbps), 1x USB 2.0
LAN	2x RJ45 (2.5 & 1 GbE)
Audio	1x Mic-in, 1x Line-out
CAN	2x CAN 2.0 A/B 2-pin Internal header
Universal I/O Bracket	RCO-1000-EHL-10 : 1x Universal I/O Bracket (By mini PCIe interface, C&T Proprietary Module) RCO-1000-EHL-20 : 3x Universal I/O Bracket (By mini PCIe interface, C&T Proprietary Module) RCO-1000-EHL-30 : 5x Universal I/O Bracket (By mini PCIe interface, C&T Proprietary Module)
Others	5x WiFi Antenna Holes 1x Power Switch, 1x AT/ATX Switch, 1x Remote Power On/Off 1x Internal CMOS Battery Cable 1x 4-PIN FAN Connector

Power	
Power Mode	AT, ATX
Power Supply Voltage	9~36VDC
Power Ignition Sensing	Adjustable power ignition management can be achieved through BIOS and optional daughter board.
Power Connector	3-pin Terminal Block
Power Adaptor	Optional AC/DC 12V/5A, 60W
Power Protection	OVP (Over Voltage Protection) OCP (Over Current Protection) Reverse Protection
Environment	
Operating Temp.	0°C to 60°C (Supported by Intel® PC Client Series: J6413), -40°C to 70°C (Supported by Intel® Embedded Series: x6425E)
Storage Temp.	-40°C to 85°C
Relative Humidity	10% to 95% (non-condensing)
Vibration	<ul style="list-style-type: none"> <li>With SSD: 5 Grms, 5 - 500 Hz, 0.5 hr/axis</li> <li>With HDD: 1 Grms, 5 - 500 Hz, 0.5 hr/axis</li> </ul>
Shock	With SSD: 50G, half sine, 11ms
Standards / Certification	UL, CE, FCC Class A
Physical	
Construction	Extruded Aluminum with Heavy Duty Metal
Dimension	<ul style="list-style-type: none"> <li>RCO-1000-EHL-10 : 150 (W) x 105 (D) x 49 (H) mm</li> <li>RCO-1000-EHL-20 : 150 (W) x 105 (D) x 66 (H) mm</li> <li>RCO-1000-EHL-30 : 150 (W) x 105 (D) x 83 (H) mm</li> </ul>
Weight	<ul style="list-style-type: none"> <li>RCO-1000-EHL-10 : 0.9 kg</li> <li>RCO-1000-EHL-20 : 1.0 kg</li> <li>RCO-1000-EHL-30 : 1.2 kg</li> </ul>
Mounting	<ul style="list-style-type: none"> <li>Wall Mounting</li> <li>SIDE/VESA/DIN-Rail Mounting (Optional)</li> </ul>

## 1.3 System I/O

### 1.3.1 RCO-1000-EHL-10

#### Front Panel

- **ATX power on/off switch**  
Press to power-on or power-off the system
- **AT/ATX mode select switch**  
Used to select AT or ATX power mode
- **Power LED**  
Indicates the power status of the system
- **HDD LED**  
Indicates the status of the hard drive
- **Watchdog LED**  
Indicates the watchdog status of the system
- **USB 3.2 Gen 2**  
Used to connect USB 3.2 device
- **USB 2.0 port**  
Used to connect USB 2.0 device
- **SIM card**  
Used to insert a SIM card
- **LAN port**  
Used to connect the system to a local area network
- **Line-out**  
Used to connect a speaker
- **Mic-in**  
Used to connect a microphone
- **Remote power on/off**  
Used to plug a power on/off with terminal block
- **Reset Hole**  
Used to reset the system
- **Antenna hole**  
Used to connect an antenna for optional Mini-PCle WiFi module

#### Front Panel

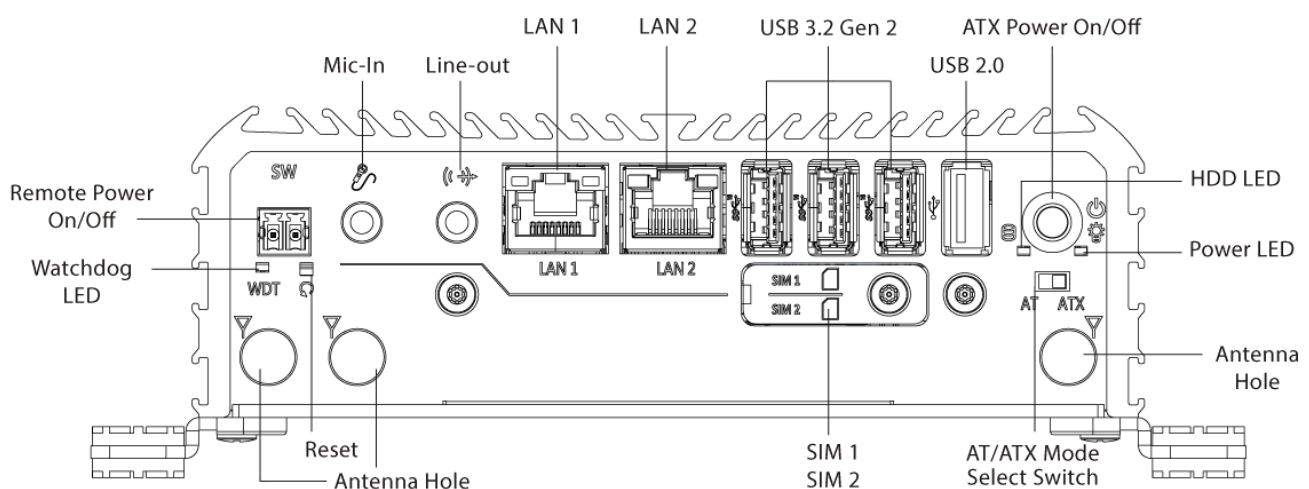

### 1.3.1 RCO-1000-EHL-10

#### Rear Panel

- **DC IN**  
Used to plug a DC power input with terminal block
- **DisplayPort**  
Used to connect a DisplayPort monitor
- **COM port**  
COM1 ~ COM2 support RS232/422/485 serial device
- **Antenna hole**  
Used to connect an antenna for optional Mini-PCIe WiFi module
- **Expandable I/O bracket**  
Used to customized I/O output

#### Rear Panel

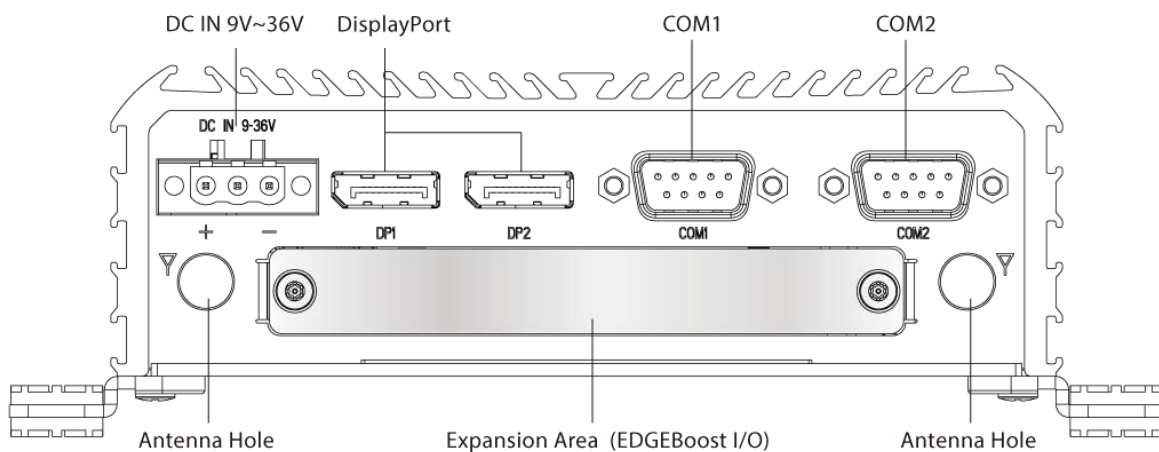

#### Available Expansion Module Options for Rear Panel

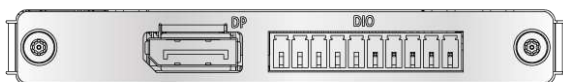

- 1x DP Port and 1x DIO (4 in / 4 out, Isolated)



- 1x HDMI Port



- 4x USB Ports



- 2x COM Ports

## 1.3.2 RCO-1000-EHL-20

### Front Panel

- **ATX power on/off switch**  
Press to power-on or power-off the system
- **AT/ATX mode select switch**  
Used to select AT or ATX power mode
- **Power LED**  
Indicates the power status of the system
- **HDD LED**  
Indicates the status of the hard drive
- **Watchdog LED**  
Indicates the watchdog status of the system
- **USB 3.2 Gen 2**  
Used to connect USB 3.2 device
- **USB 2.0 port**  
Used to connect USB 2.0 device
- **SIM card**  
Used to insert a SIM card
- **LAN port**  
Used to connect the system to a local area network
- **Line-out**  
Used to connect a speaker
- **Mic-in**  
Used to connect a microphone
- **Remote power on/off**  
Used to plug a power on/off with terminal block
- **Reset Hole**  
Used to reset the system
- **Antenna hole**  
Used to connect an antenna for optional Mini-PCIe WiFi module

### Front Panel

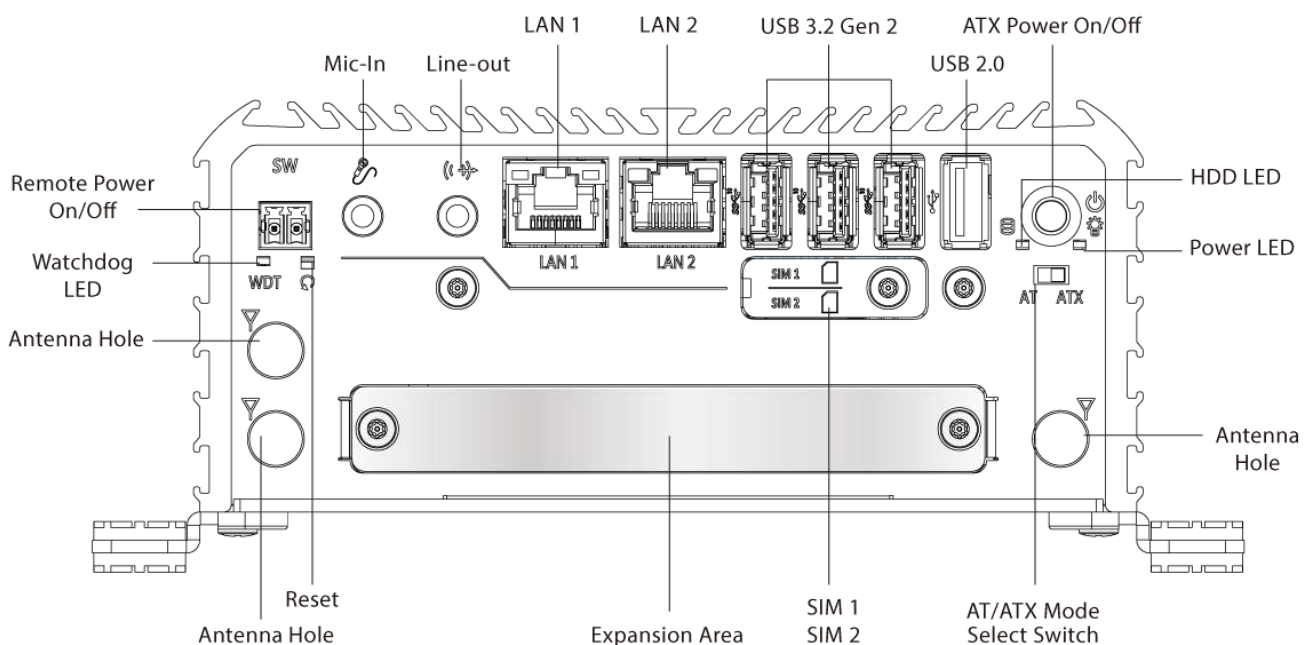



### 1.3.2 RCO-1000-EHL-20

#### Rear Panel

- **DC IN**  
Used to plug a DC power input with terminal block
- **DisplayPort**  
Used to connect a DisplayPort monitor
- **COM port**  
COM1 ~ COM2 support RS232/422/485 serial device
- **Antenna hole**  
Used to connect an antenna for optional Mini-PCIe WiFi module
- **Expandable I/O bracket**  
Used to customized I/O output

Rear Panel

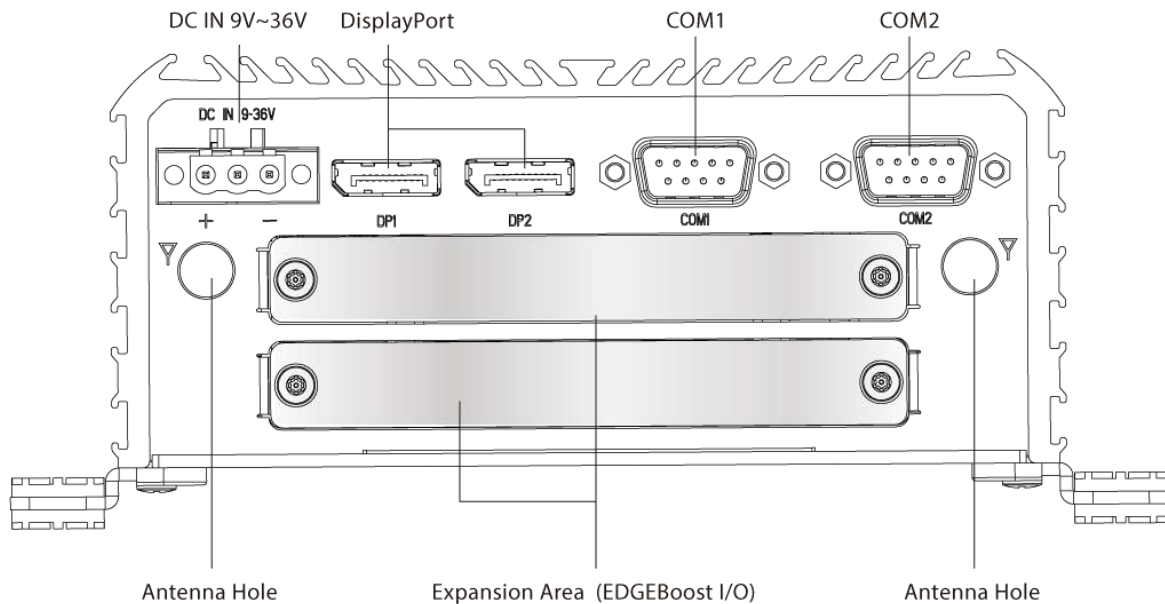

#### Available Expansion Module Options for Rear Panel



- 1x DP Port and 1x DIO (4 in / 4 out, Isolated)  
(Support 1x Universal Slot Only)



- 1x HDMI Port  
(Support 1x Universal Slot Only)



- 4x USB Ports  
(Support 1x Universal Slot Only)



- 2x COM Ports  
(Support 2x Universal Slot Only)

### 1.3.3 RCO-1000-EHL-30

#### Front Panel

- **ATX power on/off switch**  
Press to power-on or power-off the system
- **AT/ATX mode select switch**  
Used to select AT or ATX power mode
- **Power LED**  
Indicates the power status of the system
- **HDD LED**  
Indicates the status of the hard drive
- **Watchdog LED**  
Indicates the watchdog status of the system
- **USB 3.2 Gen 2**  
Used to connect USB 3.2 device
- **USB 2.0 port**  
Used to connect USB 2.0 device
- **SIM card**  
Used to insert a SIM card
- **LAN port**  
Used to connect the system to a local area network
- **Line-out**  
Used to connect a speaker
- **Mic-in**  
Used to connect a microphone
- **Remote power on/off**  
Used to plug a power on/off with terminal block
- **Reset Hole**  
Used to reset the system
- **Antenna hole**  
Used to connect an antenna for optional Mini-PCIe WiFi module

#### Front Panel

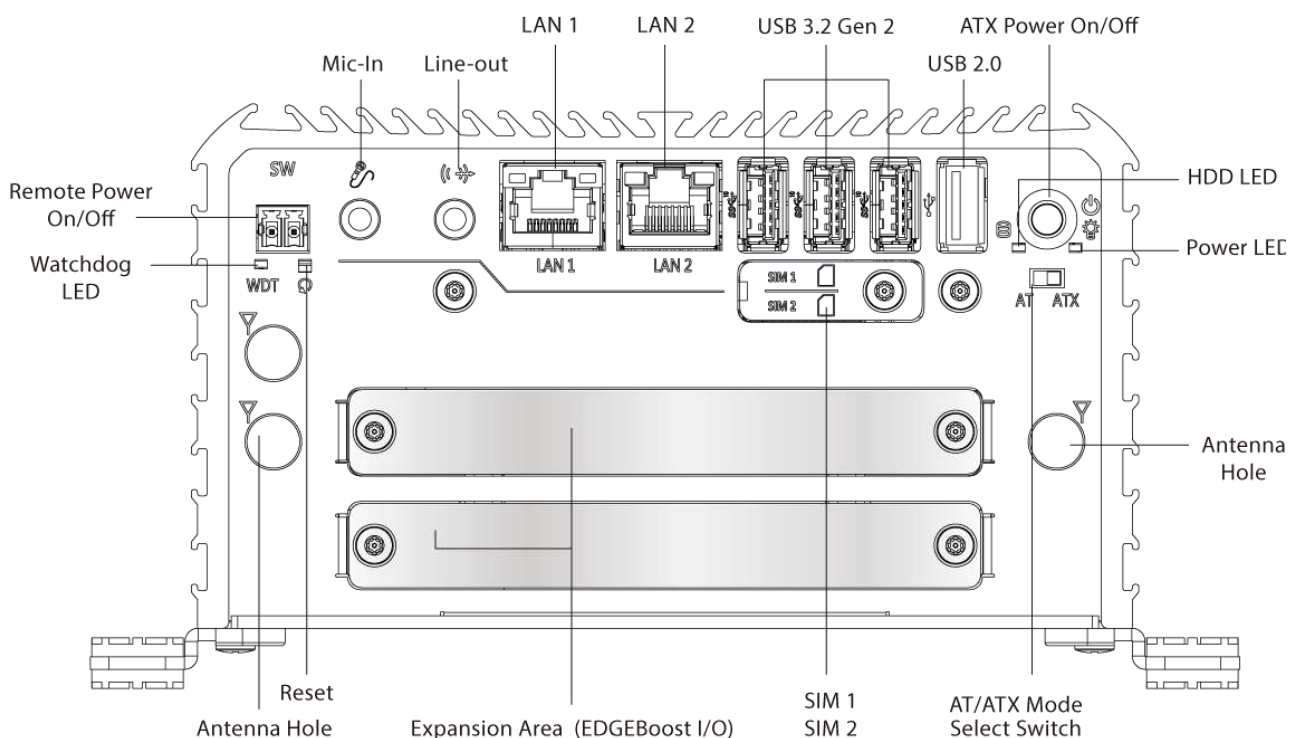

### 1.3.3 RCO-1000-EHL-30

#### Rear Panel

- **DC IN**  
Used to plug a DC power input with terminal block
- **DisplayPort**  
Used to connect a DisplayPort monitor
- **COM port**  
COM1 ~ COM2 support RS232/422/485 serial device
- **Antenna hole**  
Used to connect an antenna for optional Mini-PCIe WiFi module
- **Expandable I/O bracket**  
Used to customized I/O output

#### Rear Panel

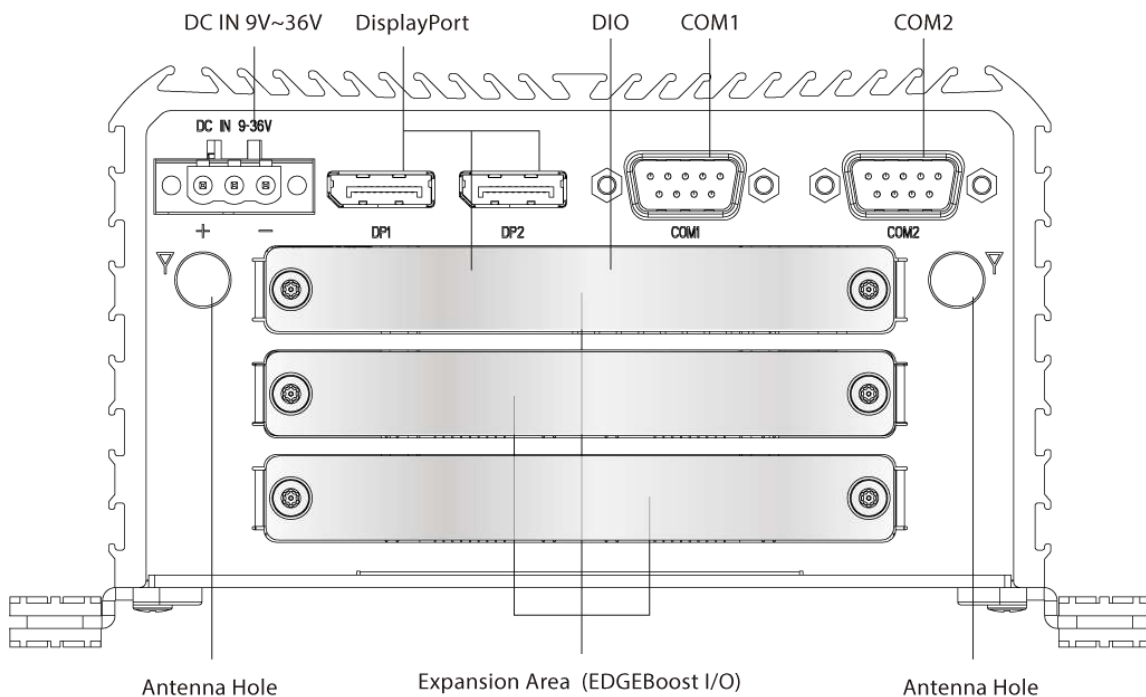

#### Available Expansion Module Options for Rear Panel



- 1x DP Port and 1x DIO (4 in / 4 out, Isolated)  
(Support 1x Universal Slot Only)



- 1x HDMI Port  
(Support 1x Universal Slot Only)

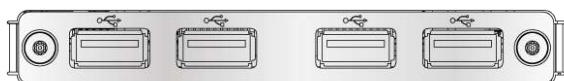

- 4x USB Ports  
(Support 1x Universal Slot Only)



- 2x COM Ports  
(Support 2x Universal Slot Only)

## 1.4 Mechanical Dimensions

### 1.4.1 RCO-1000-EHL-10

Unit: mm

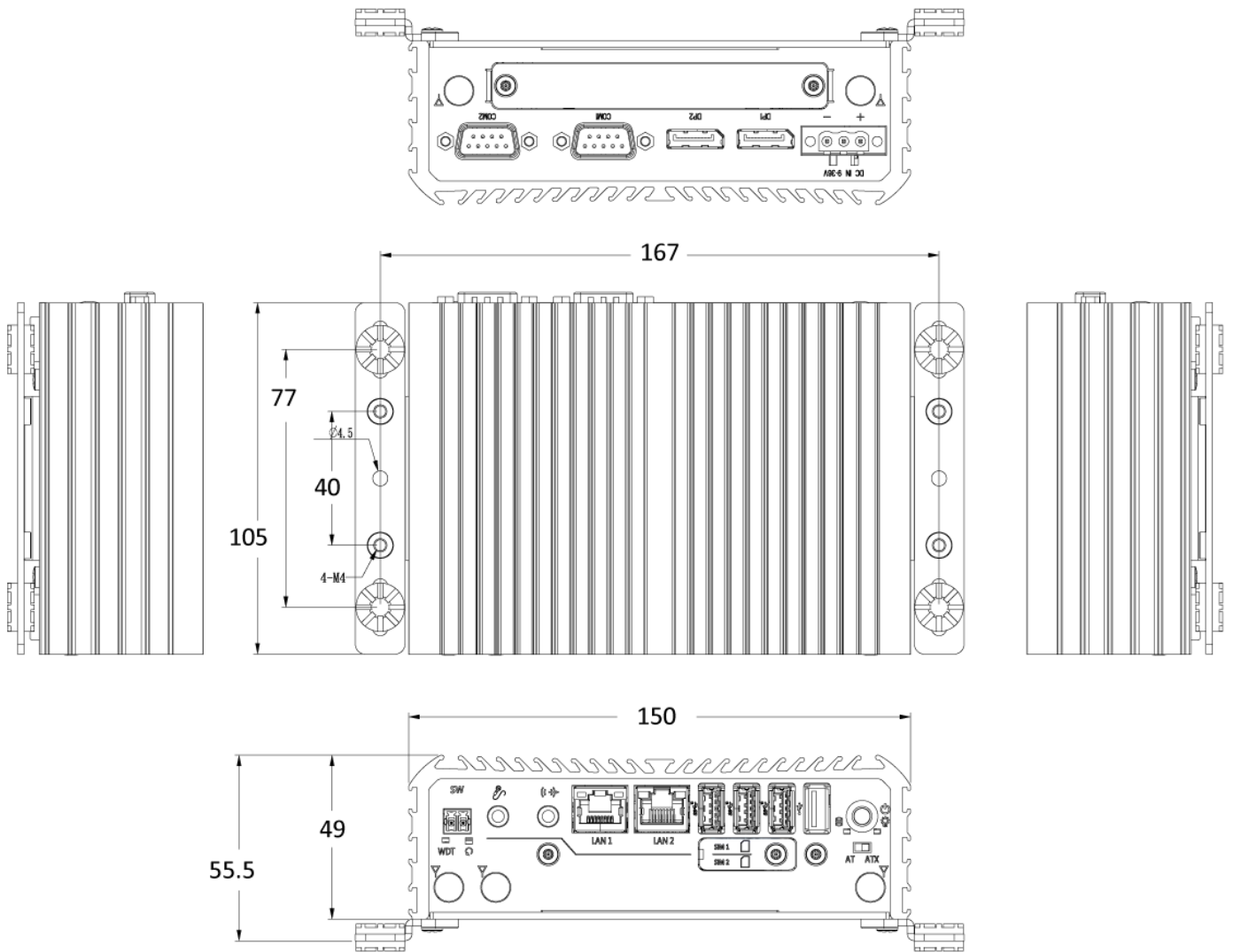

1.4.2 RCO-1000-EHL-20

Unit: mm

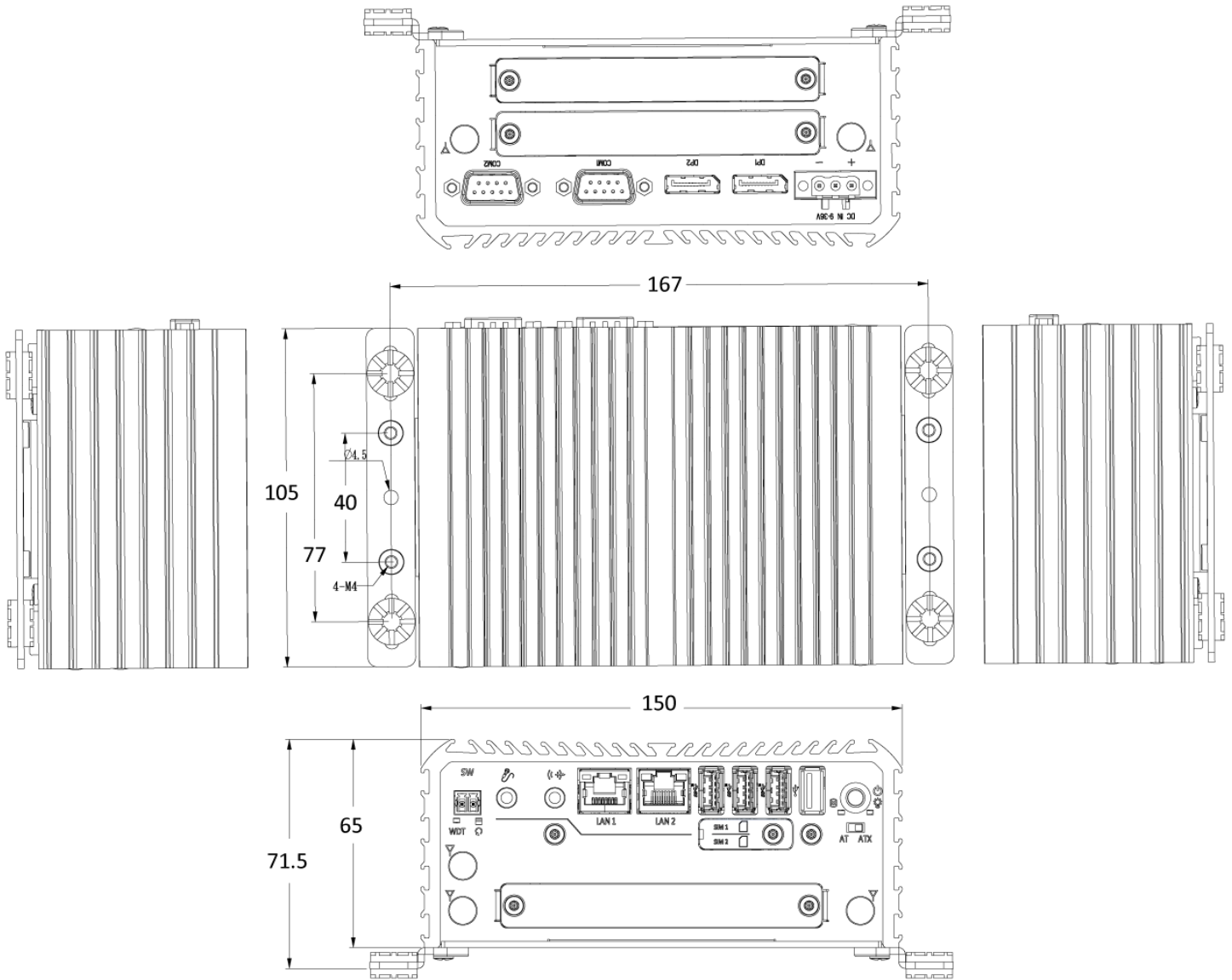

1.4.3 RCO-1000-EHL-30

Unit: mm

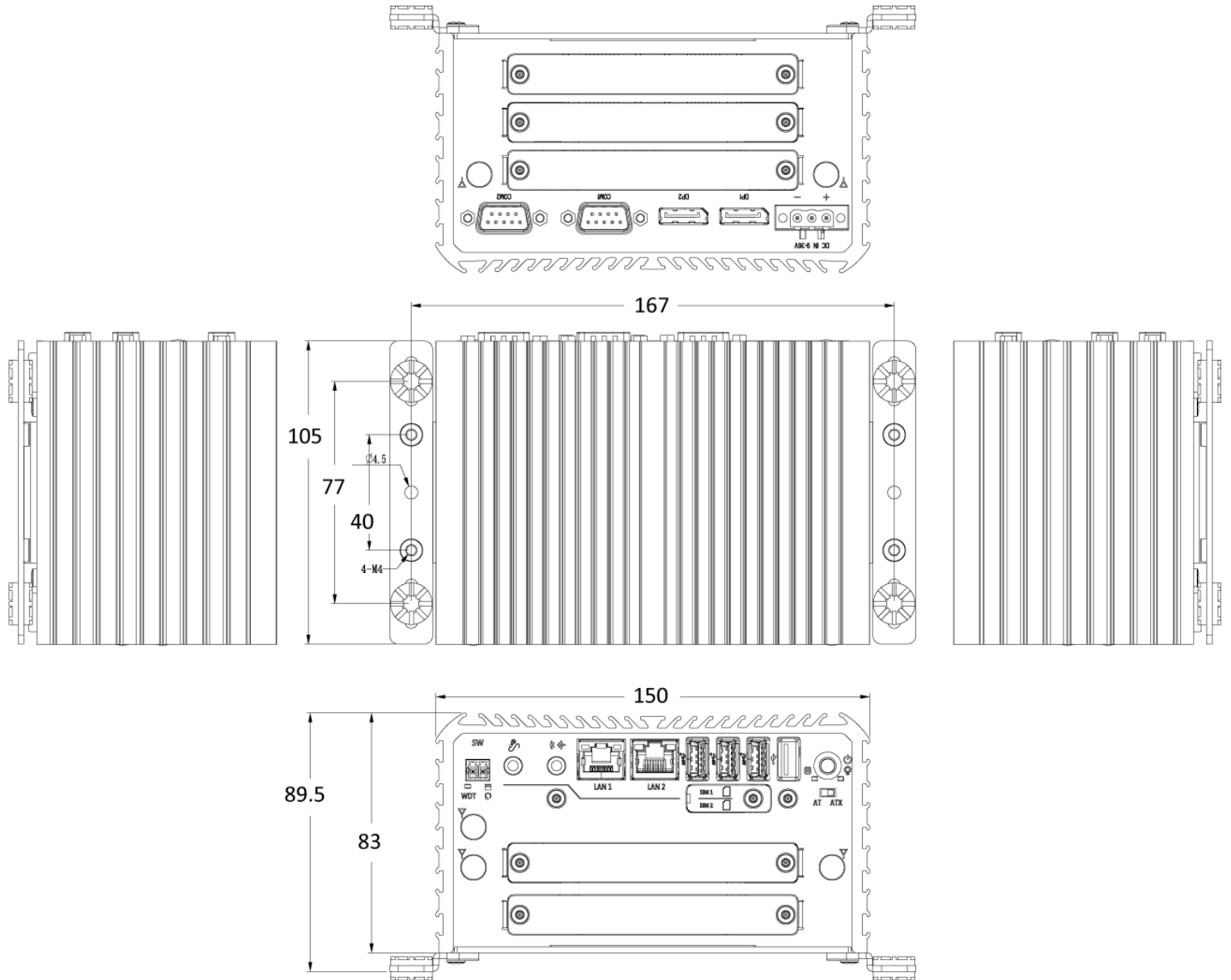

## Chapter 2

# Switches and Connectors

## 2.1 Switch and Connector Locations

### 2.1.1 Top View

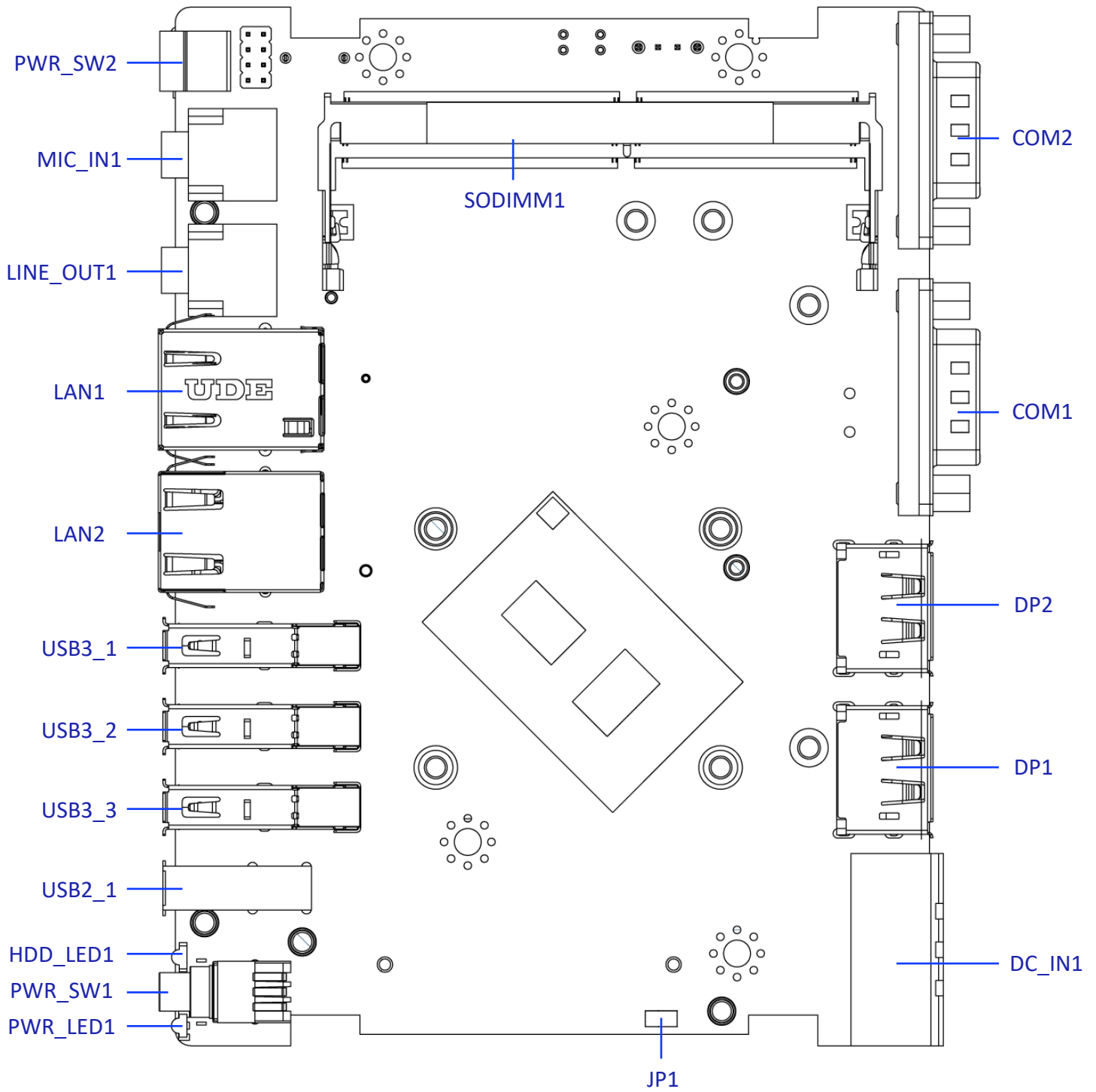



2.1.2 Bottom View

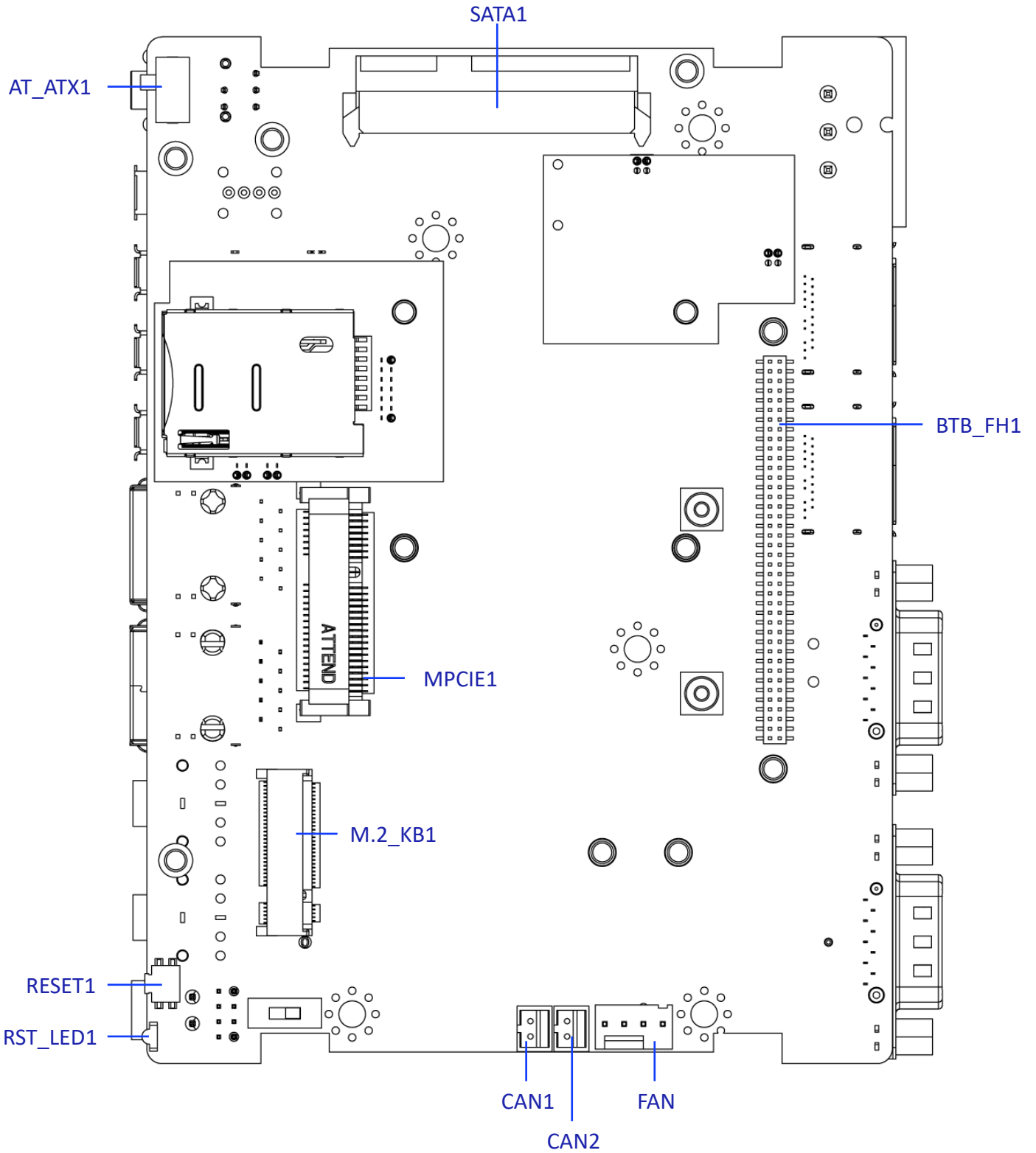

### 2.1.3 Daughter board view

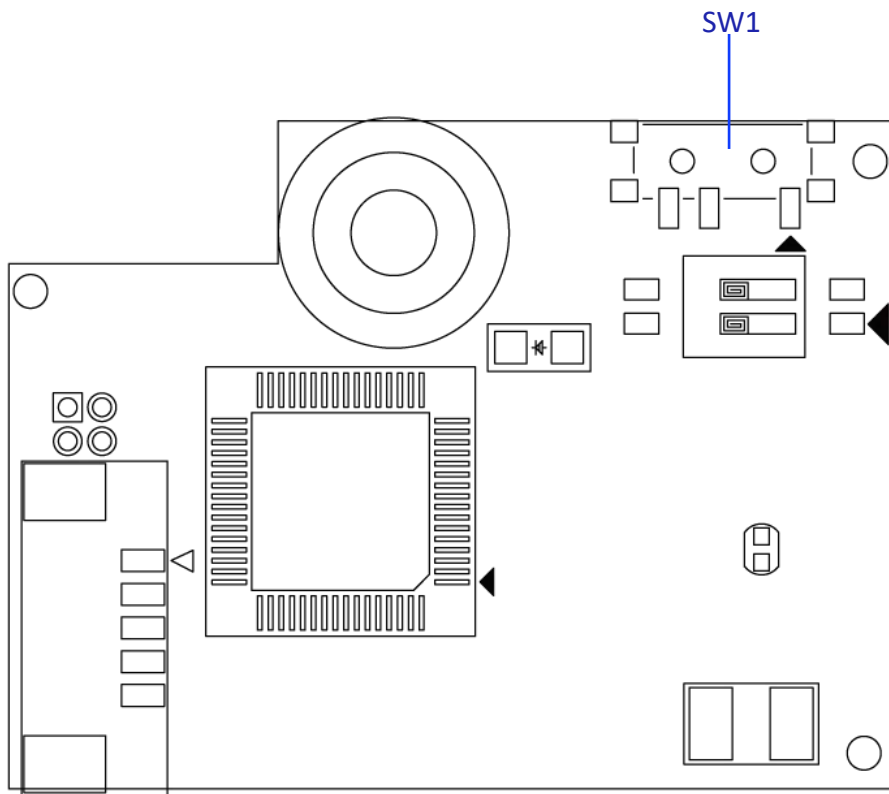

## 2.2 Connector / Switch Definition

### List of Connector / Switch

Connector Location	Definition
DC_IN1	3-pin DC +9~36V Power Input Connector
PWR_SW1	Power Switch
PWR_SW2	Remote Power Switch
DP1 - 2	Display Port
COM1 - 2	RS232 / RS422 / RS485 Connector
USB2_1	USB2.0 Port
USB3_1 - 3	USB 3.2 Gen 2 Port
LAN1	1G bit/s LAN Port
LAN2	2.5G bit/s LAN Port
MIC_IN1	Mic-in Jack
LINE_OUT1	LINE-OUT Jack
PWR_LED1	Power LED Status
HDD_LED1	HDD Access LED Status
AT_ATX1	AT / ATX Power Mode Switch
SATA1	SATA with Power Connector
FAN	Smart FAN Connector
CAN1 - 2	CAN Bus Connector
MPCIE1	Mini PCI-Express Socket
M.2_KB1	M.2 B-Key Socket
RESET1	Reset Switch
RST_LED1	Reset LED Status
SIM1, SIM2	SIM Card Socket
DIO1	4DI/DO Connector
CN1 - 2	RS232 / RS422 / RS485 Connector
SW1	PC mode / CAR mode select

## 2.3 Switches Definitions

### 2.3.1 DC Power Input Connector (+9~36V)

#### DC\_IN1

Connector Type: Terminal Block 1X3 3-pin, 5.0mm pitch

Switch	Definition
1	9~36 VIN
3	GND

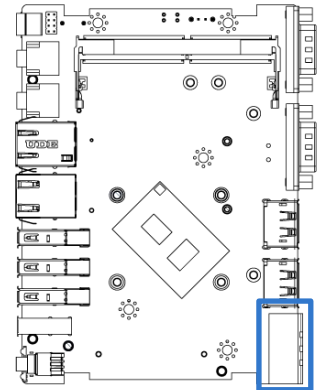
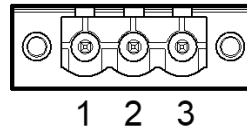

### 2.3.2 Power Button

#### PWR\_SW1

Pin	Definition	Pin	Definition
1	NC	4	GND
2	Power Button	5	NC
3	NC	6	GND

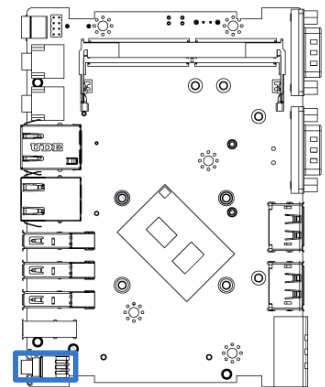

### 2.3.3 Remote Power Switch

#### PWR\_SW2

Connector Type: Terminal Block 1X2 2-pin, 3.5mm pitch

Pin	Definition
1	Power Button
2	GND

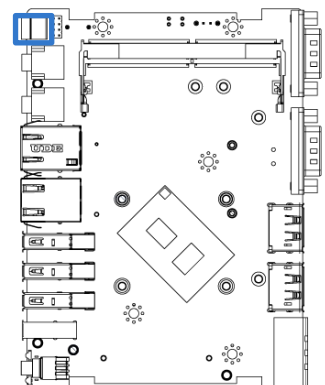

### 2.3.4 DisplayPort Connector

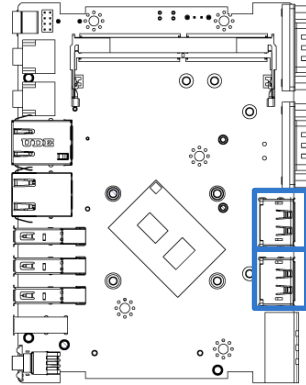
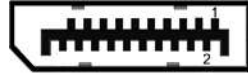

#### DP1-2

Pin	Definition	Pin	Definition
1	DP_LANE0_P	11	GND
2	GND	12	DP_LANE3_N
3	DP_LANE0_N	13	GND
4	DP_LANE1_P	14	GND
5	GND	15	DP_AUX_P
6	DP_LANE1_N	16	GND
7	DP_LANE2_P	17	DP_AUX_N
8	GND	18	DP_HPD
9	DP_LANE2_N	19	GND
10	DP_LANE3_P	20	DP_PWR

### 2.3.5 RS232 / RS422 / RS485 Connector

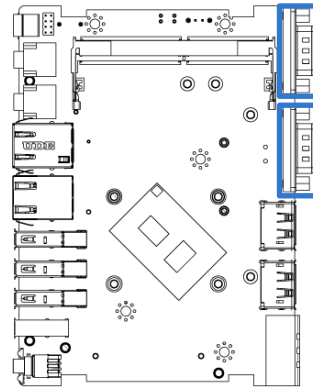
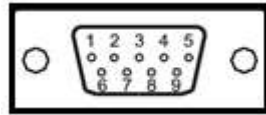

#### COM1-2

Connector Type: 9-pin D-Sub

Pin	RS232 Definition	RS422 / 485 Full Duplex Definition	RS485 Half Duplex Definition
1	DCD2	TX2-	DATA2-
2	RxD2	TX2+	DATA2+
3	TxD2	RX2+	
4	DTR2	RX2-	
5	GND		
6	DSR2		
7	RTS2		
8	CTS2		
9	RI2		

### 2.3.6 USB2.0 Connector, Type A

#### USB2\_1

Pin	Definition
1	+5V
2	USB2_D2-
3	USB2_D2+
4	GND

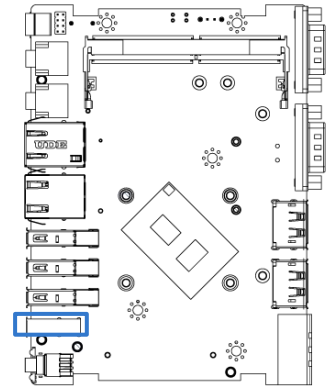
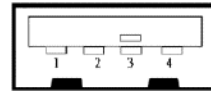

### 2.3.7 USB 3.2 Connector, Type A

#### USB3\_1-3

Pin	Definition	Pin	Definition
1	+5V	6	USB3_RX+
2	USB2_DATA1-	7	GND
3	USB2_DATA1+	8	USB3_TX-
4	GND	9	USB3_TX+
5	USB3_RX-		

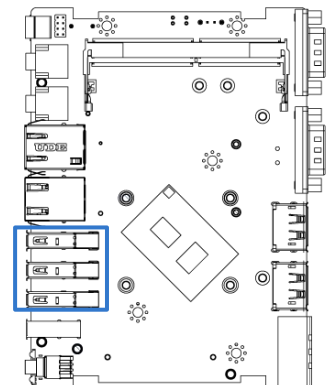
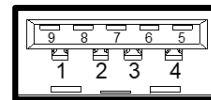

### 2.3.8 RJ45 with LEDs Port

#### LAN1

Pin	Definition	Pin	Definition
1	LAN1_MDI0P	5	LAN1_MDI2N
2	LAN1_MDI0N	6	LAN1_MDI1N
3	LAN1_MDI1P	7	LAN1_MDI3P
4	LAN1_MDI2P	8	LAN1_MDI3N

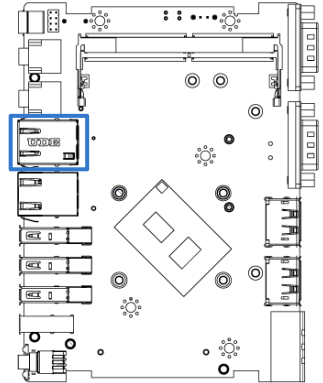
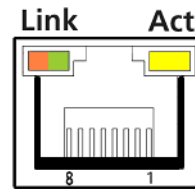

Link LED Status	Definition	Act LED Status	Definition
Steady Orange	1Gbps Network Link	Blinking Yellow	Data Activity
Steady Green	100Mbps Network Link	Off	No Activity
Off	10Mbps Network Link		

#### LAN2

Pin	Definition	Pin	Definition
1	LAN1_MDI0P	5	LAN1_MDI2N
2	LAN1_MDI0N	6	LAN1_MDI1N
3	LAN1_MDI1P	7	LAN1_MDI3P
4	LAN1_MDI2P	8	LAN1_MDI3N

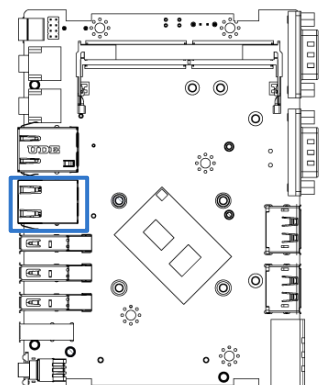
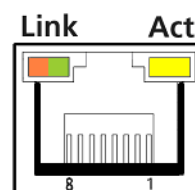

Link LED Status	Definition	Act LED Status	Definition
Steady Orange	1Gbps Network Link	Blinking Yellow	Data Activity
Steady Green	2.5Gbps Network Link	Off	No Activity
Off	10Mbps Network Link		



### 2.3.9 Microphone Jack (Pink)

#### MIC\_IN1

Connector Type: 5-pin Phone Jack

Pin	Definition
1	GND
2	MIC_R
3	NC
4	GND
5	MIC_L

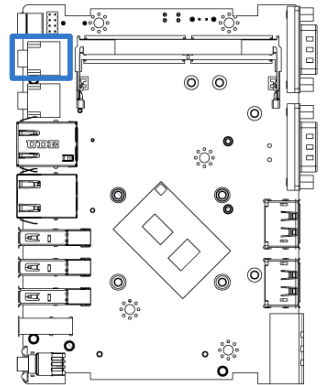

### 2.3.10 Line-out Jack (Green)

#### LINE\_OUT1

Connector Type: 5-pin Phone Jack

Pin	Definition
1	GND
2	OUT_R
3	NC
4	GND
5	OUT_L

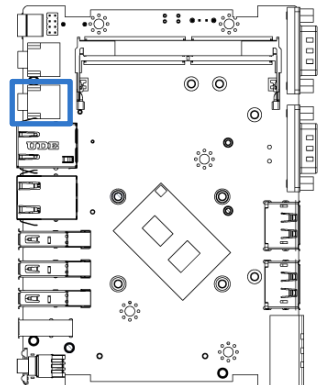

#### PWR\_LED1: Power LED Status

Pin	Definition
1	POWER LED+
2	POWER LED-



#### HDD\_LED1: HDD Access LED Status

Pin	Definition
1	HDD LED+
2	HDD LED-



#### RESET1 : Reset Button

Pin	Definition
1	RESET
2	GND



#### RST\_LED1: Power LED Status

Pin	Definition
1	RST LED
2	RST LED

2.3.11 AT / ATX Power Mode Switch

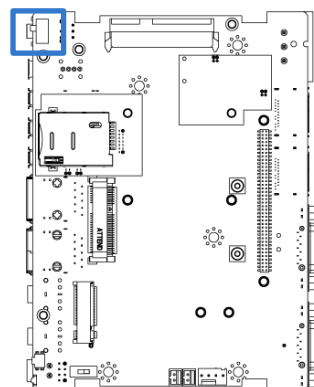
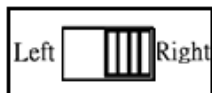

AT\_ATX1

Switch	Definition
1-2 (Right)	ATX Power Mode ( Default )
2-3 (Left)	AT Power Mode

2.3.12 SATA with Power Connector

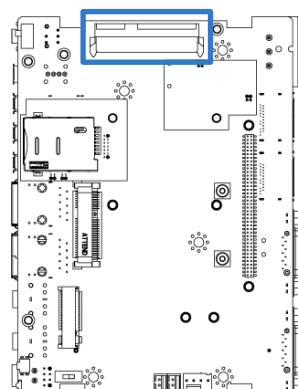
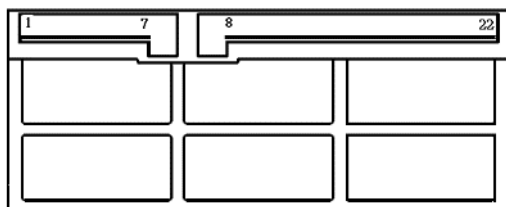

SATA1

Pin	Definition	Pin	Definition
1	GND	12	GND
2	SATA_TXP1	13	GND
3	SATA_TXN1	14	+5V
4	GND	15	+5V
5	SATA_RXN1	16	+5V
6	SATA_RXP1	17	GND
7	GND	18	GND
8	+3.3V	19	GND
9	+3.3V	20	+12V
10	+3.3V	21	+12V
11	GND	22	+12V

### 2.3.13 Smart FAN Connector

#### FAN

Pin	Definition
1	GND
2	+12V
3	FANIN
4	FANCTL

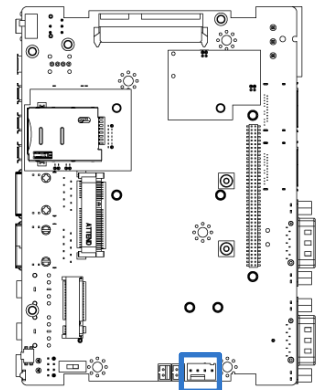
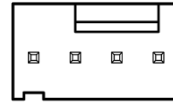

### 2.3.14 CAN Bus Connector

#### CAN 1-2

Pin	Definition
1	CAN_H
2	CAN_L

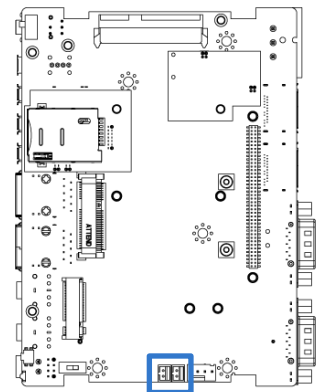
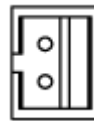

## 2.3.15 Mini PCI-Express / mSATA Socket

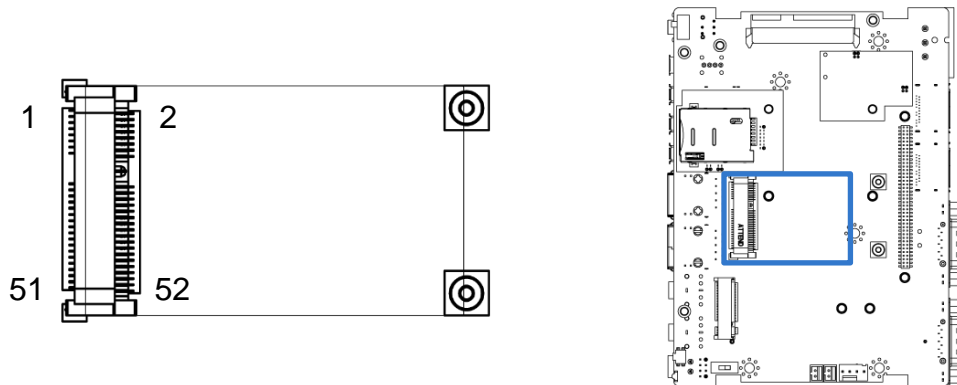

## MPCIE1

Pin	Definition	Pin	Definition	Pin	Definition
1	WAKE#	19	NC	37	GND
2	+3.3V	20	+3.3V	38	USB_DP1
3	NC	21	GND	39	+3.3V
4	GND	22	MINIPCIE_RST#	40	GND
5	NC	23	MINIPCIE_RXN1	41	+3.3V
6	+1.5V	24	+3.3V	42	NC
7	CLKREQ1#	25	MINIPCIE_RXP1	43	GND
8	USIM_VCC	26	GND	44	NC
9	GND	27	GND	45	NC
10	USIM_DATA	28	+1.5V	46	NC
11	MINIPCIE_CLKN1	29	GND	47	NC
12	USIM_CLK	30	SMB_CLK	48	+1.5V
13	MINIPCIE_CLKP1	31	MINIPCIE_TXN1	49	NC
14	USIM_RST	32	SMB_DATA	50	GND
15	GND	33	MINIPCIE_TXP1	51	NC
16	USIM_VPP	34	GND	52	+3.3V
17	NC	35	GND		
18	GND	36	USB_DN1		

2.3.16 M.2 B Key Socket

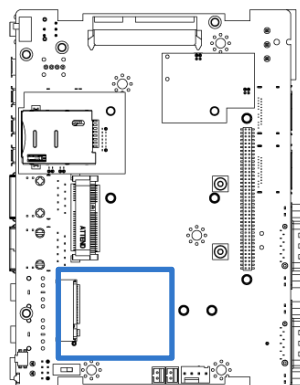
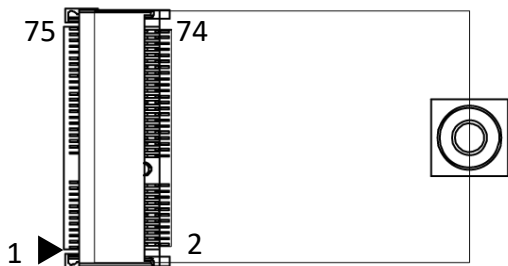

M2\_KB1

Pin	Definition	Pin	Definition
1	+3.3V	2	+3.3V
3	GND	4	+3.3V
5	GND	6	+1.8S
7	USB2_D+	8	+3.3V
9	USB2_D-	10	NC
11	GND		
21	+3.3V	20	NC
23	NC	22	NC
25	NC	24	NC
27	GND	26	NC
29	USB_RxNO	28	NC
31	USB_RxPO	30	SIM_RST
33	GND	32	SIM_CLK
35	USB_TxNO	34	SIM_DATA
37	USB_TxPO	36	SIM_VDD
39	GND	38	NC
41	PCIE_RxNO	40	NC
43	PCIE_RxPO	42	NC
45	GND	44	NC
47	PCIE_TxNO	46	NC
49	PCIE_TxPO	48	NC
51	GND	50	PCIE_RST#
53	REFCLK1-	52	CLK_REQ#
55	REFCLK1+	54	PCIE_WAKE#
57	GND	56	NC
59	NC	58	NC
61	NC	60	NC
63	NC	62	NC
65	NC	64	NC
67	NC	66	NC
69	+3.3V	68	NC
71	GND	70	+3.3V
73	GND	72	+3.3V
75	+3.3V	74	+3.3V

2.3.17 SIM Card Socket

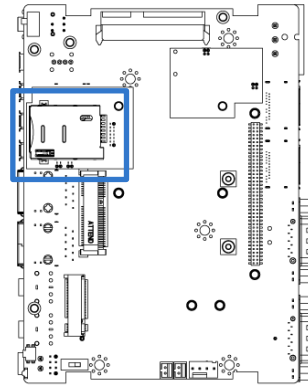
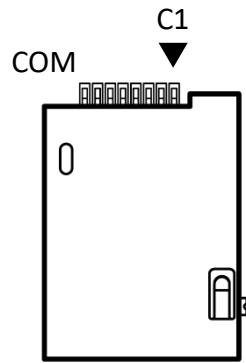

SIM1 - 2

Pin	Definition	Pin	Definition
C1	UIM_PWR	C6	UIM_VPP
C2	UIM_RESET	C7	UIM_DATA
C3	UIM_CLK	CD	NC
C5	GND	COM	GND

2.3.18 Digital Input / Output Connector

DIO1

Connector Type: Terminal Block 1X10 10-pin, 3.5mm pitch

Pin	Definition	Pin	Definition
1	DC INPUT	6	DO1
2	DI1	7	DO2
3	DI2	8	DO3
4	DI3	9	DO4
5	DI4	10	GND



### Reference Input Circuit

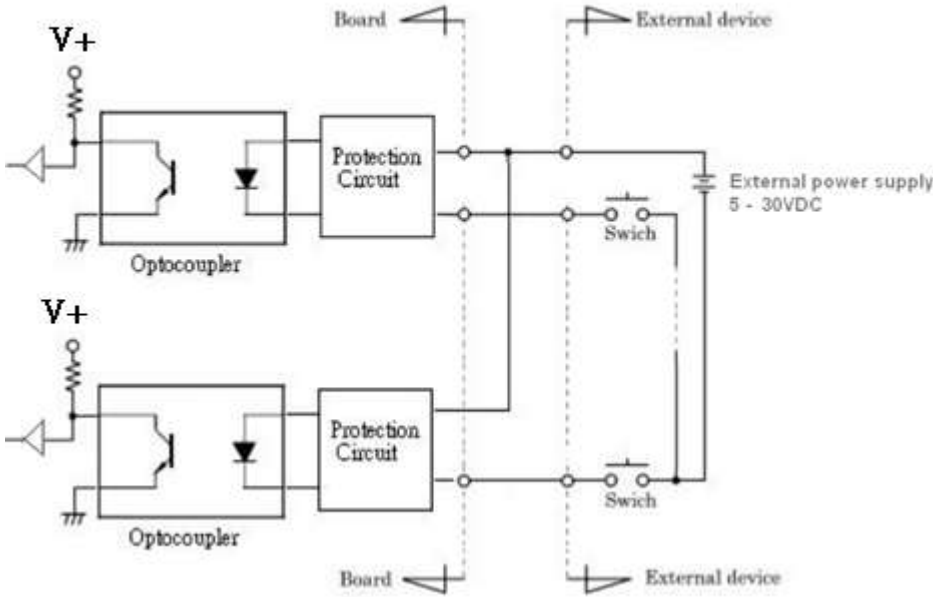

### Digital Input Wiring

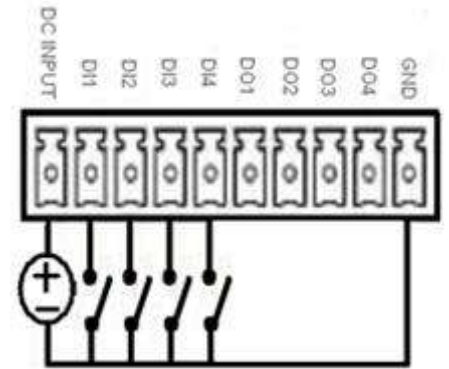

### External Output Circuit

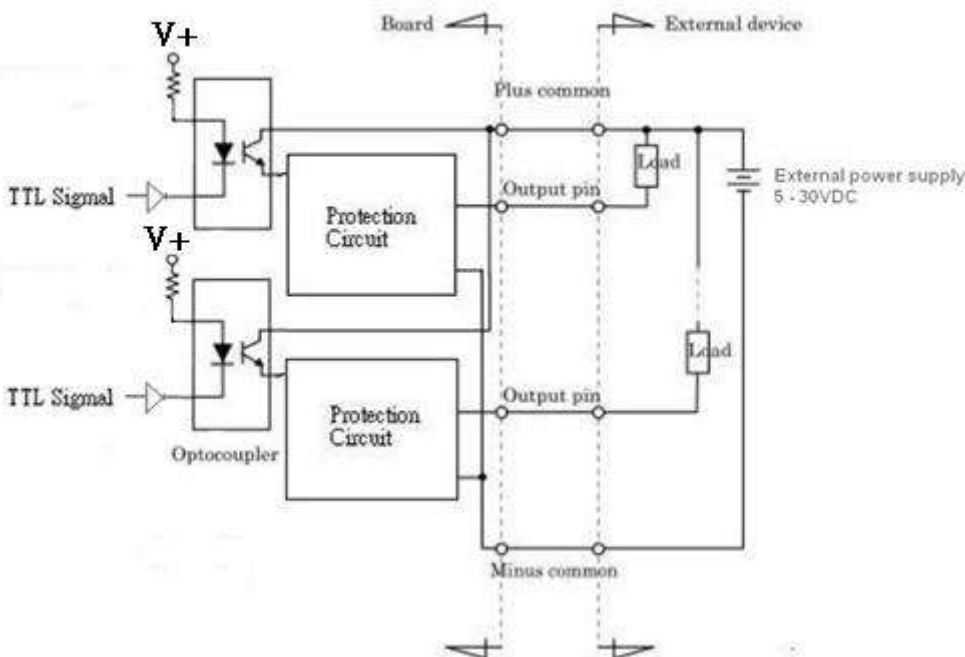

### Digital Output Wiring

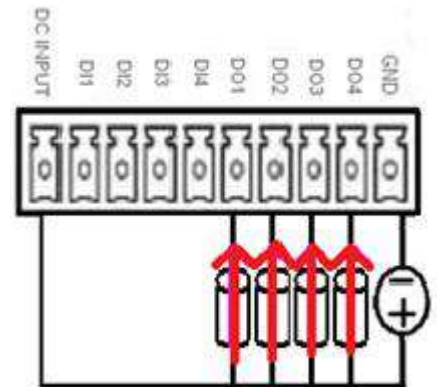

2.3.19 RS232 / RS422 / RS485 Connector

CN1 – 2

Connector Type: 9-pin D-Sub

Pin	RS232 Definition	RS422 / 485 Full Duplex Definition	RS485 Half Duplex Definition
1	DCD3 (DCD5)	TX3- (TX5-)	DATA3- (DATA5-)
2	RxD3 (RxD5)	TX3+ (TX5+)	DATA3+ (DATA5+)
3	TxD3 (TxD5)	RX3+ (RX5+)	
4	DTR3 (DTR5)	RX3- (RX5-)	
5	GND		
6	DSR3 (DSR5)		
7	RTS3 (RTS5)		
8	CTS3 (CTS5)		
9	RI3 (RI5)		

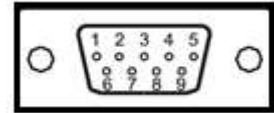

2.3.20 PC / CAR Mode Switch

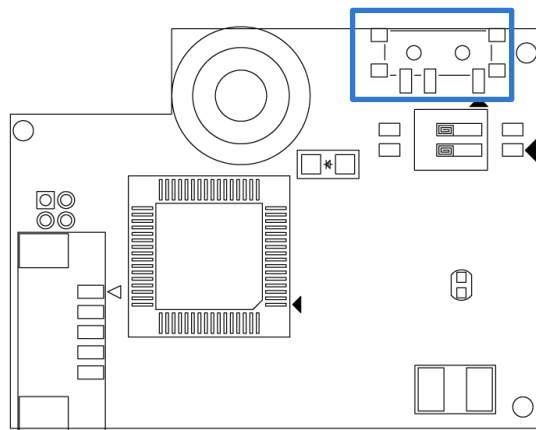

SW1

Pin	Definition
1-2	PC Mode
2-3	CAR Mode



## Chapter 3

# System Setup

### 3.1 Set torque force to 3.5 kgf-cm to execute all the screwing and unscrewing.

### 3.2 Removing the chassis bottom cover

**WARNING**

In order to prevent electric shock or system damage, before removing the chassis cover, must turn off power and disconnect the unit from power source.

1. Turn the system upside down. Unscrew the 4 screws (M3x5L) on the bottom cover.



2. Now you can remove the bottom cover.



### 3.3 Removing HDD bracket

1. Unscrew four screws (M3x5L) circled below.

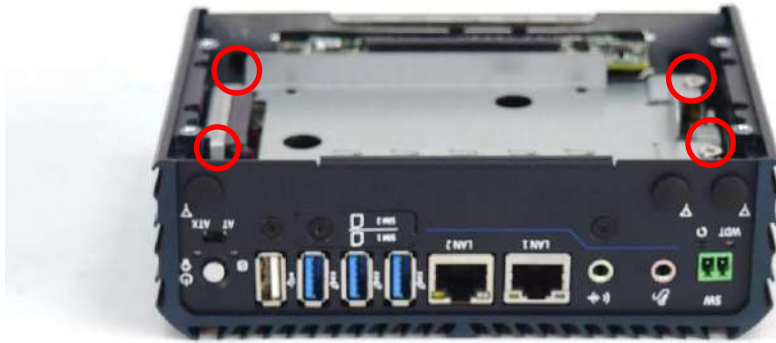

2. Now you can remove the HDD bracket.



### 3.4 Removing chassis top cover

1. Unscrew the three screws (M3x5L) and two copper stud (M3x11L) highlighted below.



2. Hold the body of the system and lift it vertically away from the top cover.



3. Top cover separated from the system body.

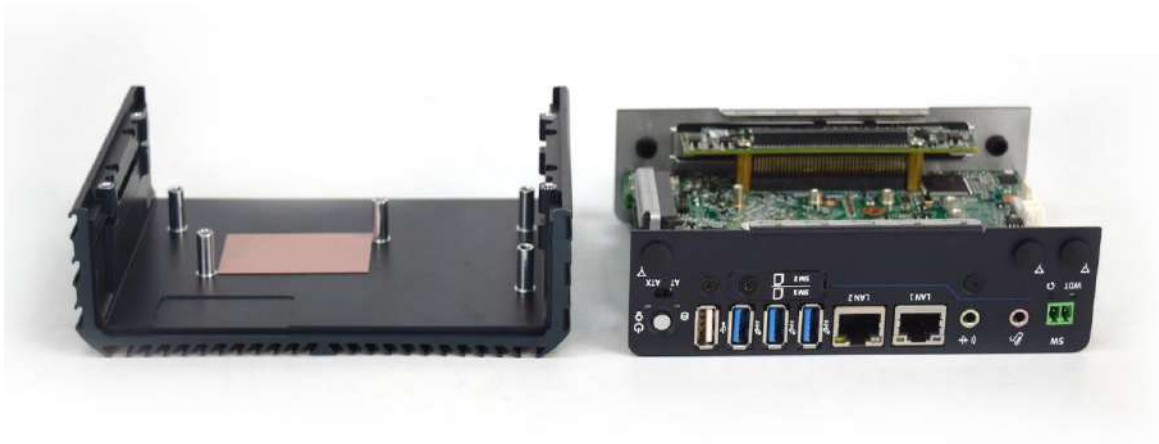

## 3.5 Installing SODIMM

1. Place the system body with SODIMM socket facing upward.



2. Insert memory module from 45 degree direction.

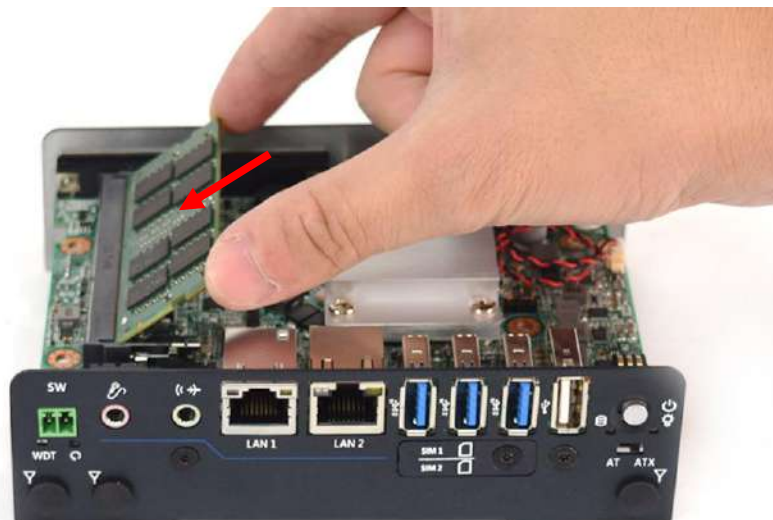

3. Press the memory module vertically downward until you hear the “click” sound. Make sure the memory module is firmly in place.



## 3.6 Installing Mini PCIe card / mSATA

1. Place the system body upside down so you can see the 2x mini card socket. Mini PCIe 2 (CN3) can support mSATA.

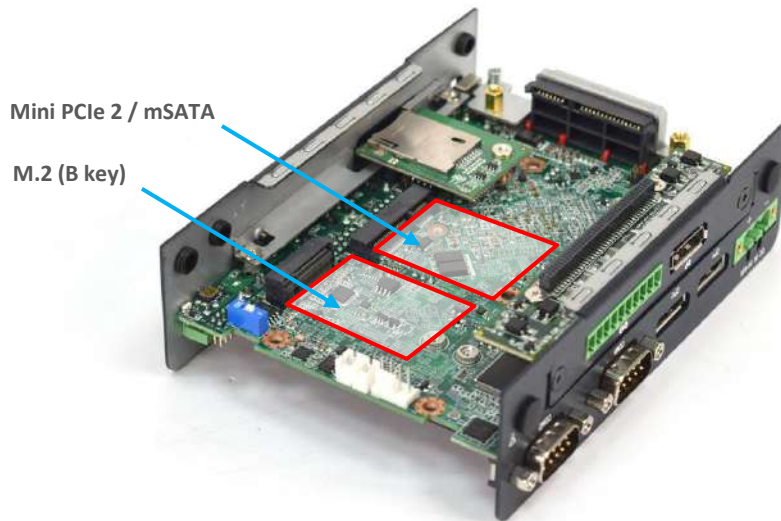

2. Insert mini PCIe card or mSATA module from 45 degree direction.



3. Press the mini PCIe card or mSATA module down and lock it with two screws (M2x3.7L).

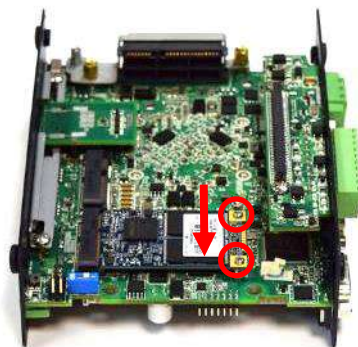

## 3.7 Installing antenna

1. Remove antenna hole cover on the system panel.



Front



Rear

2. Have antenna jack penetrate through the hole.



3. Put on washer and fasten the nut with antenna jack.



4. Assemble the antenna and antenna jack together.



5. Attach the RF connector at the cable-end onto the communication module.





## 3.8 Assemble chassis top cover

1. Place both top cover and system body upside down as shown below.



2. Ensure thermal pad is in place where the CPU is located or paste the thermal pad back on the CPU thermal block.

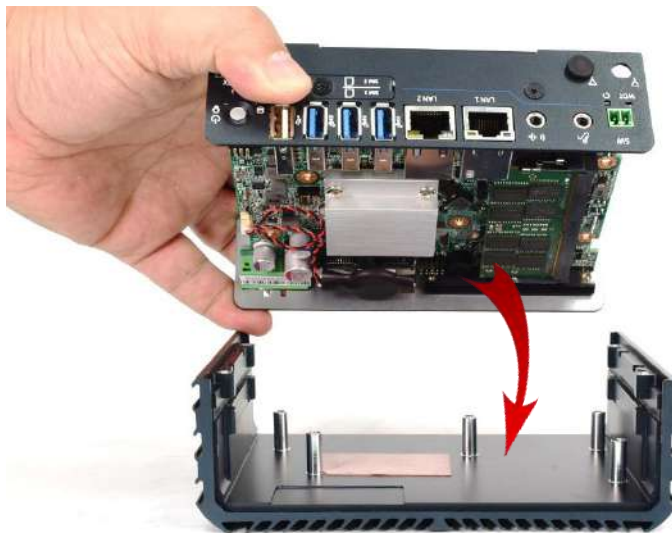

3. Put on washer and fasten the nut with antenna jack.



4. Push the system body down until it is firmly in place.



5. Fasten the three screws (M3x5L) and two copper stud (M3x11L) to lock the system body with top cover.

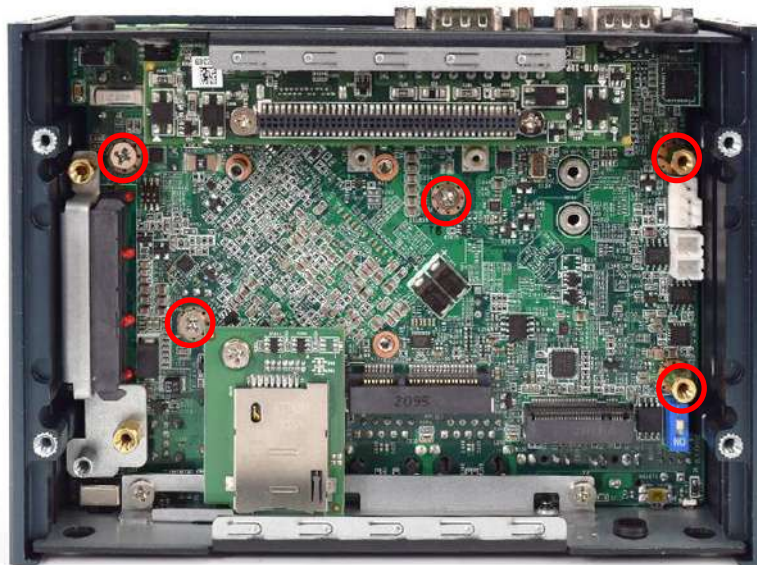

## 3.9 Installing SATA HDD

1. Lock the 2.5" HDD with HDD bracket using four screws (M3x4L).

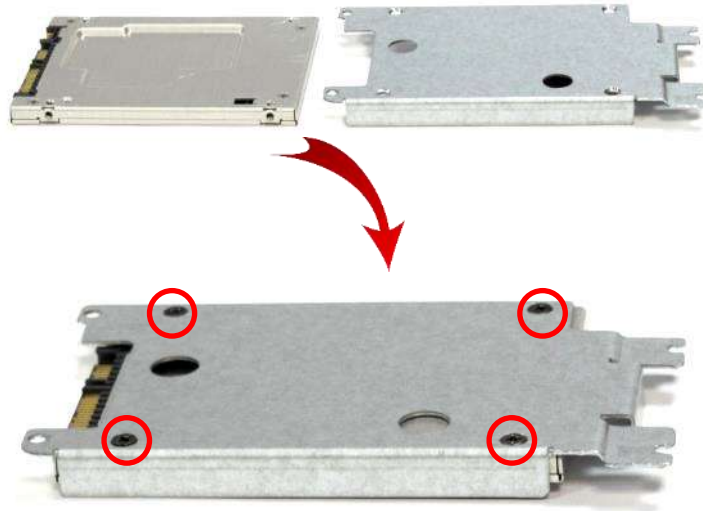

2. Slide the iron plate into the opening on top cover and then place the entire bracket down.



3. Press the entire bracket following the below direction so the SATA connector is firmly plugged into the HDD.



4. Fasten the four screws (M3x5L) to lock the HDD bracket in place.



## 3.10 Assemble chassis bottom cover

1. Place the bottom cover according to the below direction and make sure the rail is facing inside the system.



2. Lock the bottom cover with the four screws (M3x5L).



## 3.11 Installing SIM card

1. SIM card socket is located on the front panel of the system. Unscrew one screw (M3x5L) to remove the SIM card socket cover.



2. Now you can insert SIM card into the socket.



SIM 1



SIM 2

3. Please note that the installation of SIM 1 and SIM 2 has to match the installation of mini PCIe sockets.

SIM Card Socket Number	Matching Mini PCIe Slot
SIM 1	M.2_KB1
SIM 2	Mini PCIe 1

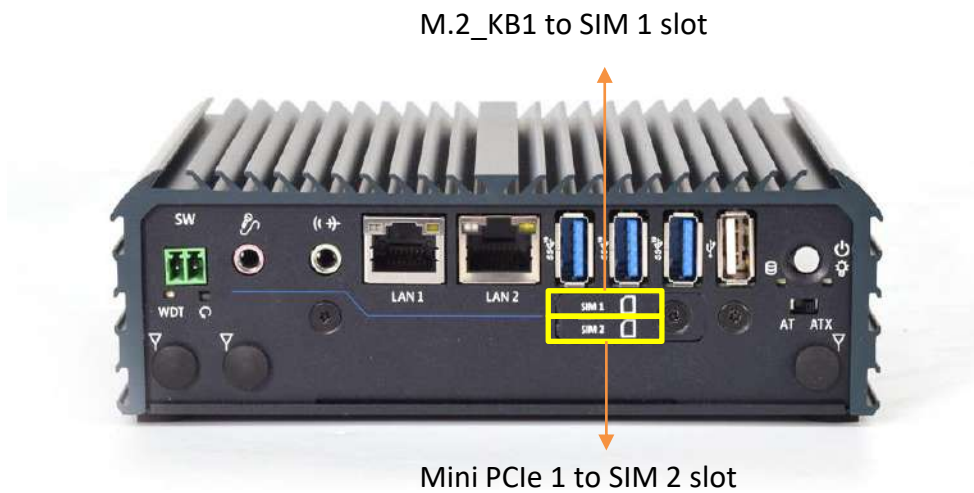

4. To uninstall SIM card, simply press the installed SIM card and then the card will be pushed out.

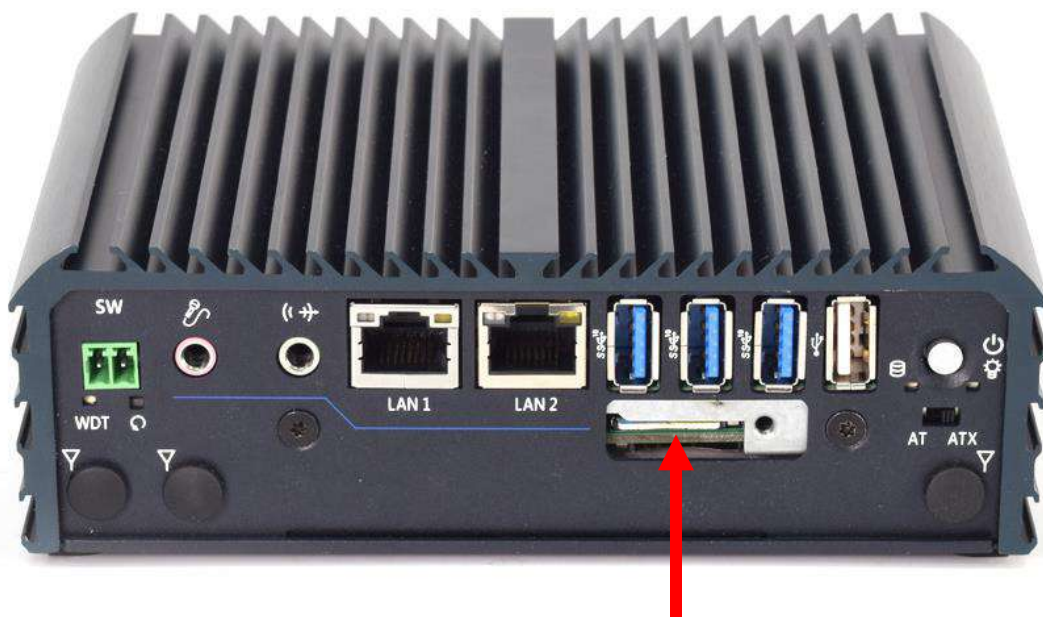

## 3.12 Installing wall mount kit

1. Wall mount kit is available for BCO-2000 series included in the standard package.



2. Place the system upside down so you can see the bottom cover. The highlighted screw holes below will be used.





3. Lock the wall mount kit with eight screws (M3x5L, Nylok).



### 3.13 Installing VESA mount kit

1. VESA mount kit is available for RCO-1000 series as optional accessories.

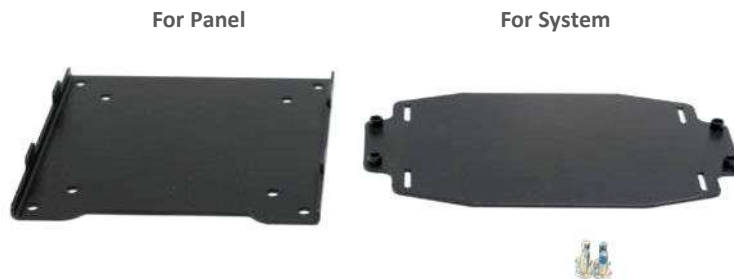

2. Place the system upside down so you can see the bottom cover. The highlighted screw holes below will be used.



3. Place the VESA mount kit (for system) on top of the system aligning the matching screw holes.



4. Lock the VESA mount kit (for system) with four screws (M3x8L, Nylok).



5. VESA mount kit (for panel) should be locked on the back of the panel with four screws.



6. Now the system can be hang in the back of the panel using the hooks.



## 3.14 Installing side mount kit

1. Side mount kit is available for RCO-1000 series as optional accessories.



2. Place the system upside down so you can see the bottom cover. The highlighted screw holes below will be used.



3. Place the side mount kit on top of the system aligning the matching screw holes.



4. Lock the side mount kit with four screws (M3x8L, Nylok).



## 3.15 Installing DIN rail holder

1. Din rail holder is available for RCO-1000 series as optional accessories.



2. Place the system upside down so you can see the bottom cover. The highlighted screw holes below will be used.

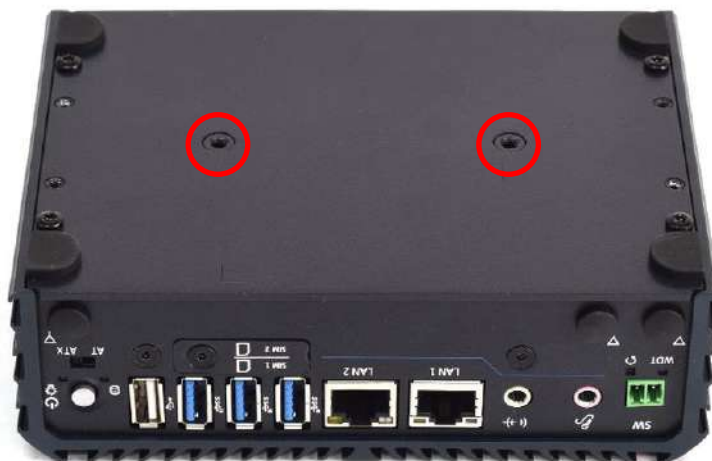

3. Place the din rail holder on top of the bottom cover and lock it with two screws (M4x5L, Nylok).



## Chapter 4

# BIOS Setup

## 4.1 BIOS Introduction

The BIOS provides an interface to modify the configuration. When the battery is removed, all the parameters will be reset.

### BIOS Setup

Power on the embedded system and by pressing <Del> immediately allows you to enter the setup screens. If the message disappears before you respond and you still wish to enter the Setup, restart the system by turning it OFF and ON or pressing the RESET button.

You may also restart the system by simultaneously pressing <Ctrl>, <Alt>, and <Delete> keys.

Control Keys	
<→> <←>	Select Screen
<↑> <↓>	Select Item
<Enter>	Select
<Page Up/+>	Increases the numeric value or makes changes
<Page Down/->	Decreases the numeric value or makes changes
<F1>	General Help
<F2>	Previous Value
<F3>	Load Optimized Defaults
<F4>	Save Configuration and Exit
<Tab>	Select Setup Fields
<Esc>	Exit BIOS Setup

### Main Setup

The main menu lists the setup functions you can make changes to. You can use the arrow keys ( ↑↓ ) to select the item. The on-line description of the highlighted setup function is displayed at the bottom of the screen.

### General Help <F1>

The BIOS setup program provides a General Help screen. You can call up this screen from any menu by simply pressing <F1>. The Help screen lists the appropriate keys to use and the possible selections for the highlighted item. Press <Esc> to exit the Help screen.



## 4.2 Main Setup

Press <Del> to enter BIOS CMOS Setup Utility. The Main setup screen is showed as following when the setup utility is entered. System Date/Time is set up in the Main Menu.

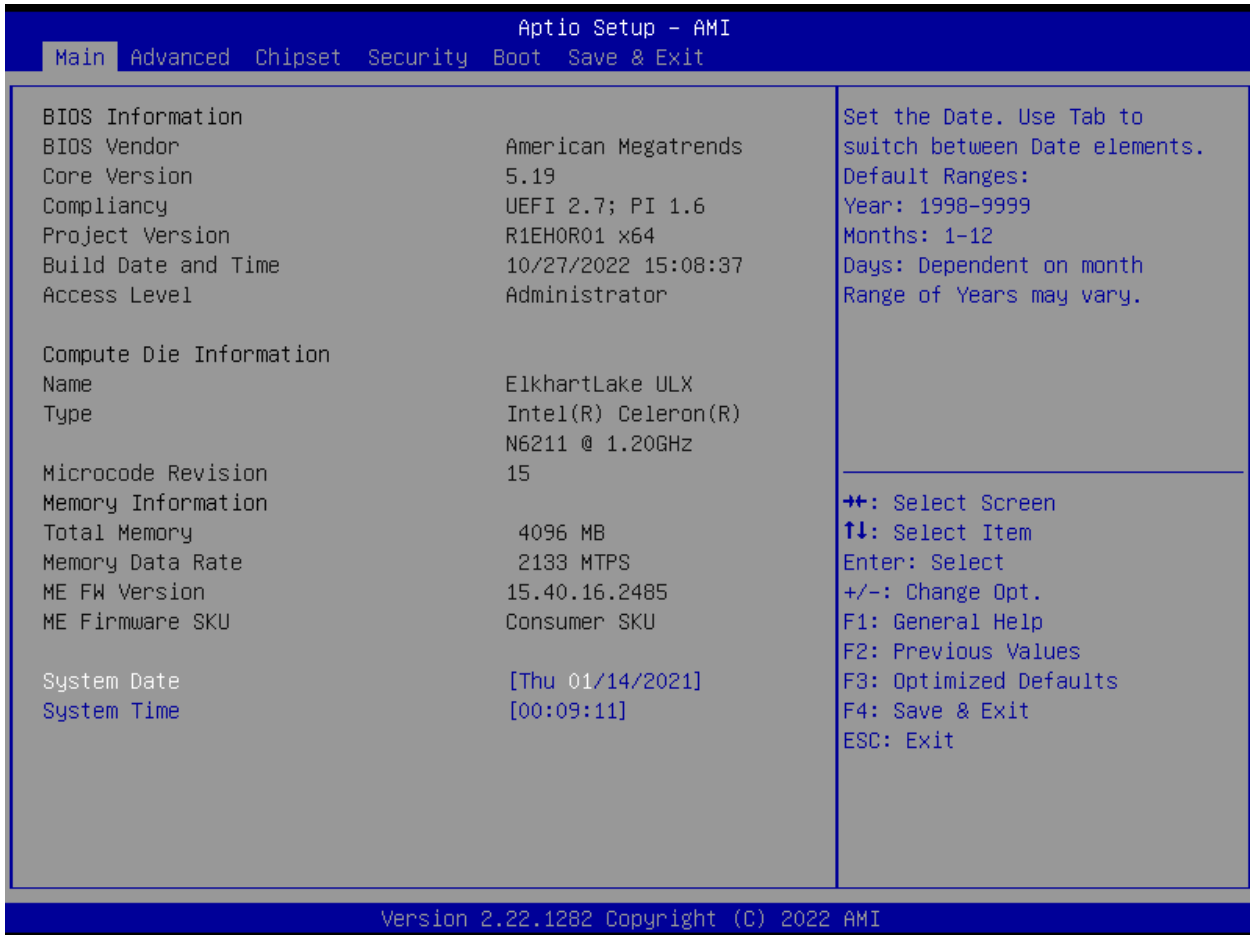

### ■ System Date

Set the system date. Please use <Tab> to switch between data elements.

### ■ System Time

Set the system time. Please use <Tab> to switch between time elements.

## 4.3 Advanced Setup

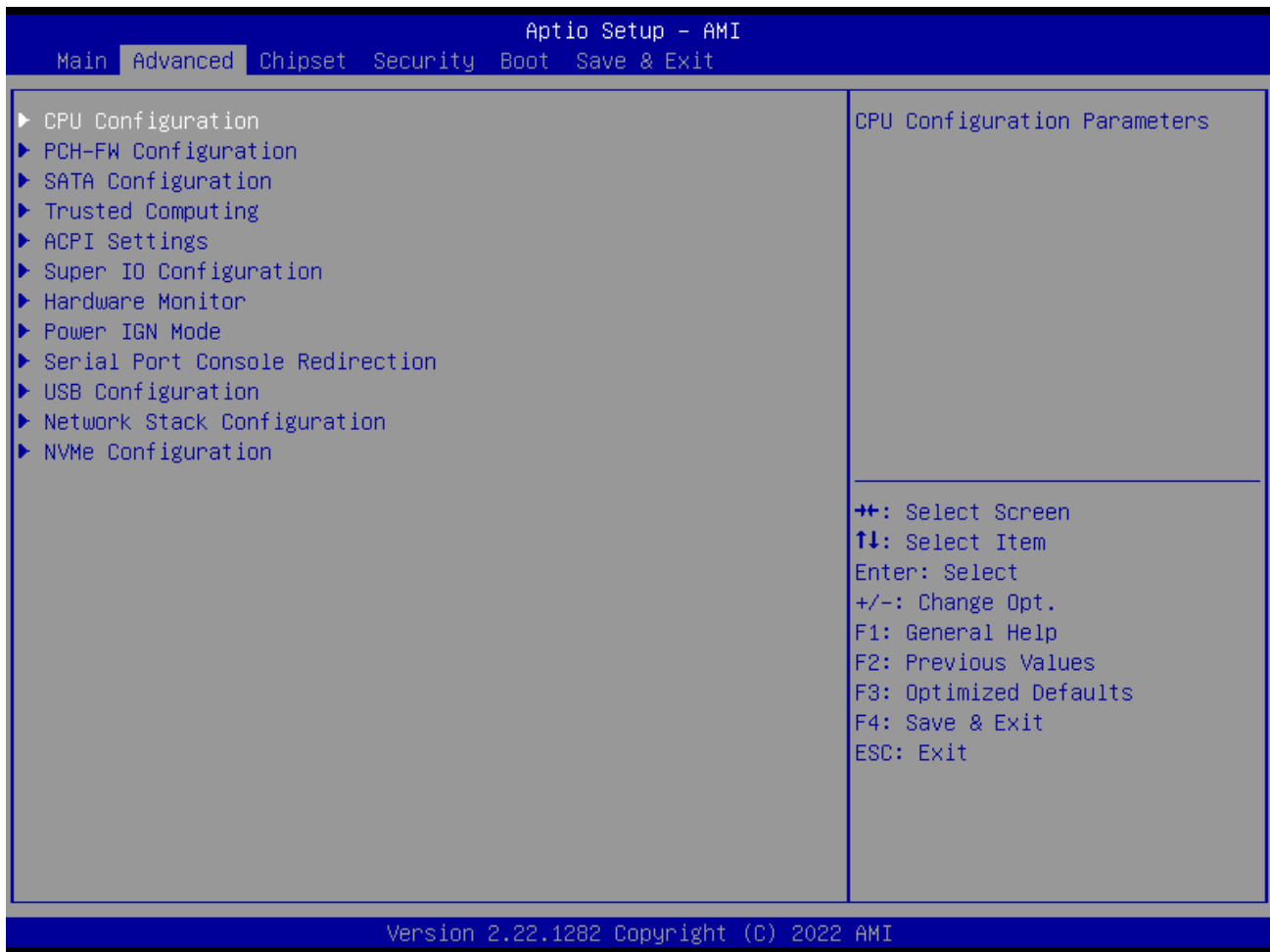

### 4.3.1 CPU Configuration

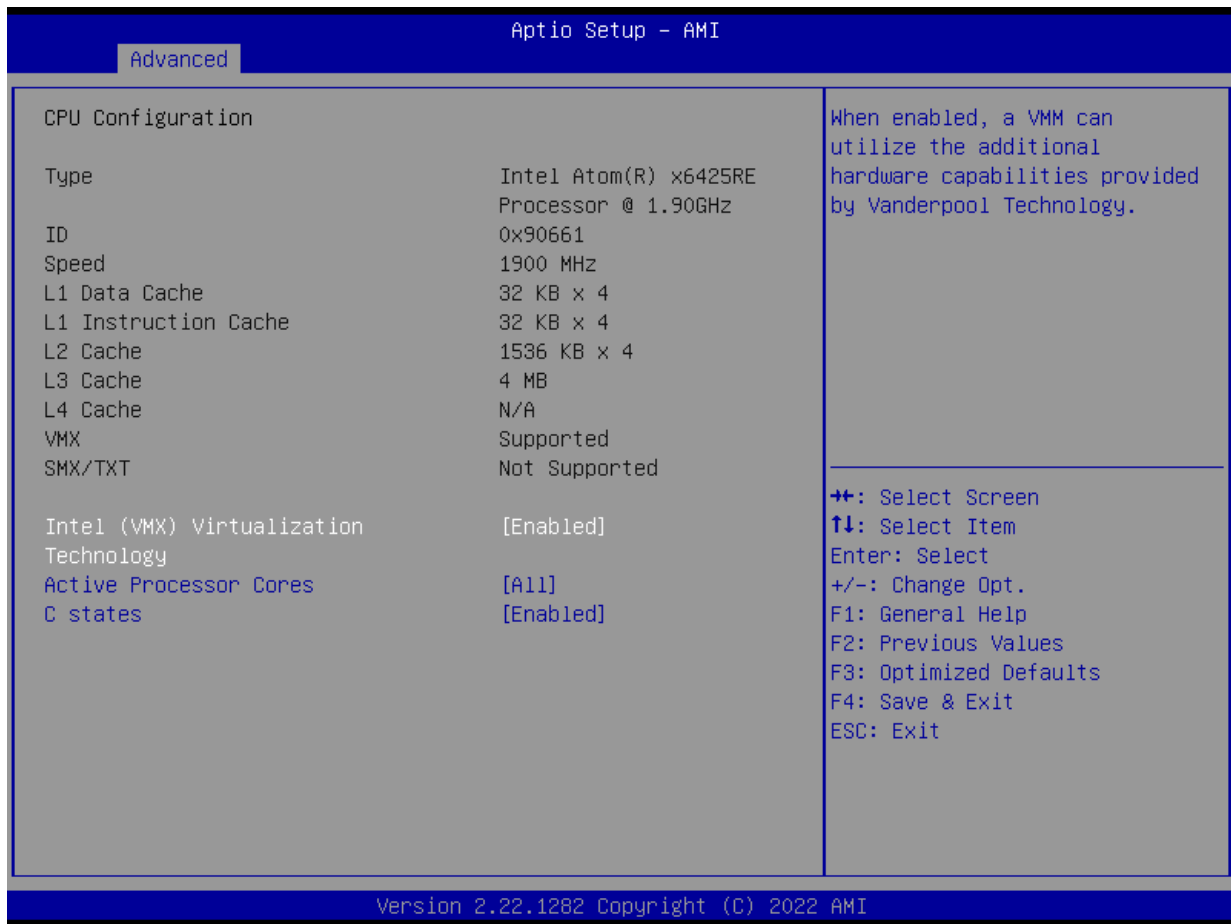

Item	Options	Description
<b>Intel (VMX) Virtualization Technology</b>	Disabled, Enabled[ <b>Default</b> ]	When enabled, a VMM can utilize the additional hardware capabilities provided by Virtualization Technology.
<b>Active Processor Cores</b>	All[ <b>Default</b> ] 1 2 3	Number of cores to enable in each processor package.
<b>C states</b>	Disabled, Enabled[ <b>Default</b> ]	Enable/Disable CPU Power Management. Allows CPU to go to C states when it's not 100% utilized.

### 4.3.2 PCH-FW Configuration

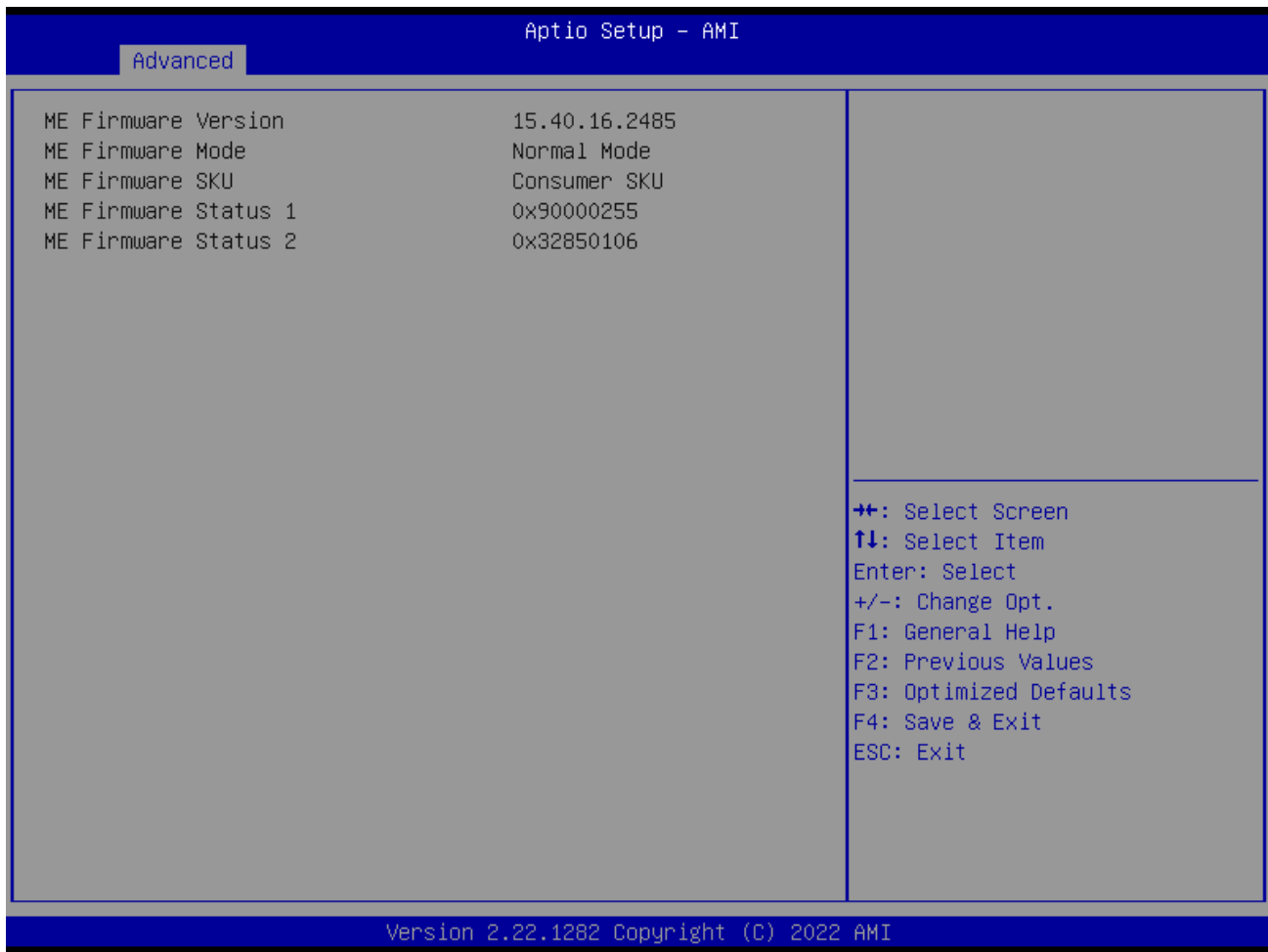

### 4.3.3 SATA and RST Configuration

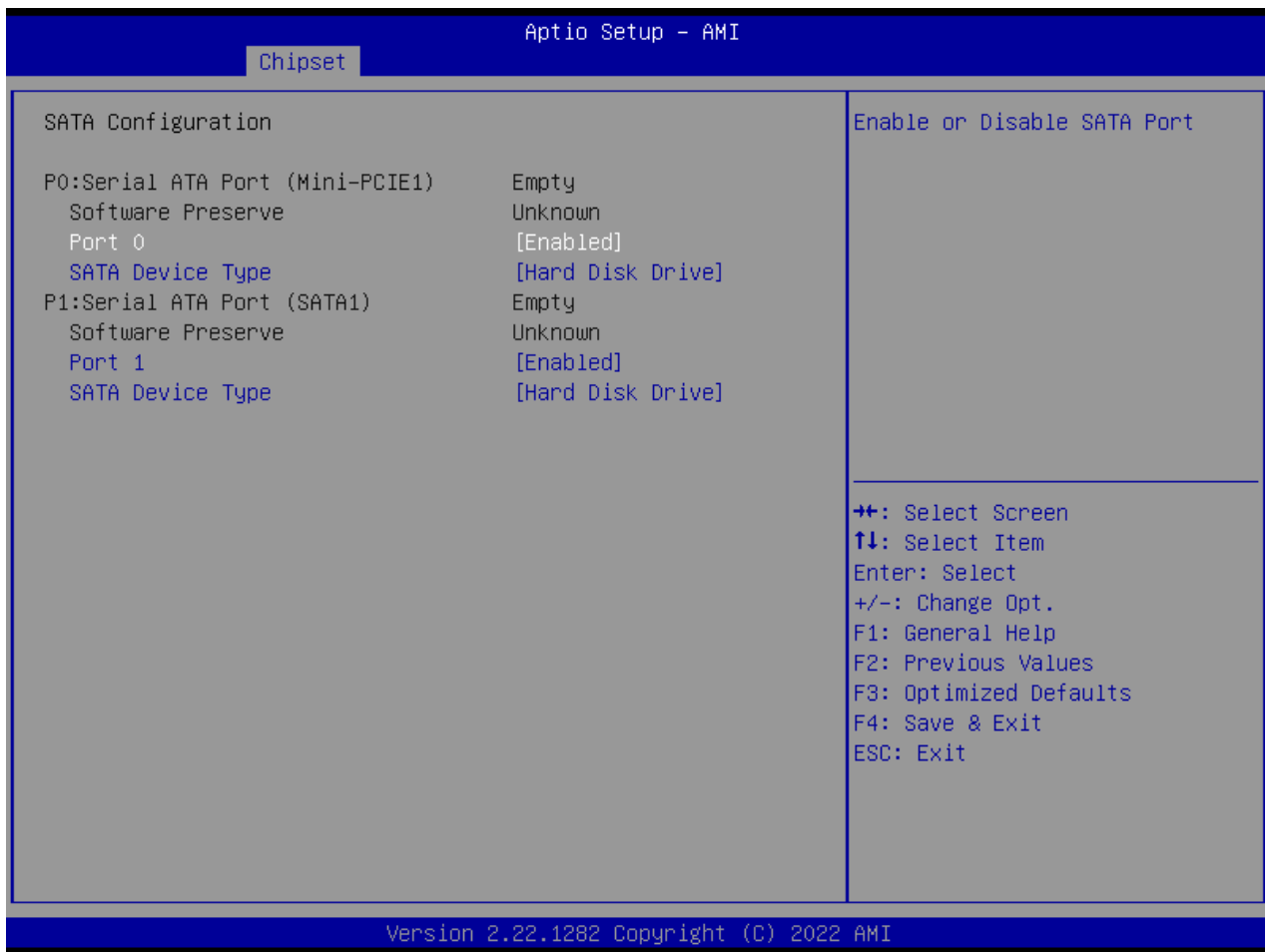

Item	Options	Description
<b>Port0 ~1</b>	Disabled, Enabled[ <b>Default</b> ]	Enable or Disable SATA Port.
<b>SATA Device Type</b>	Hard Disk Drive[ <b>Default</b> ], Solid State Drive	Identify the SATA port is connected to Solid State Drive or Hard Disk Drive.

### 4.3.4 Trusted Computing



Item	Options	Description
<b>Security Device Support</b>	Enabled[Default] , Disabled,	Enable/Disable BIOS support for security device. O.S. will not show Security Device.TCG EFI protocol and INT1A interface will not be available.
<b>Pending operation</b>	None[Default] , TPM Clear	Schedule an Operation for the Security Device. NOTE: Your Computer will reboot during restart in order to change State of Security Device.

### 4.3.5 ACPI Settings

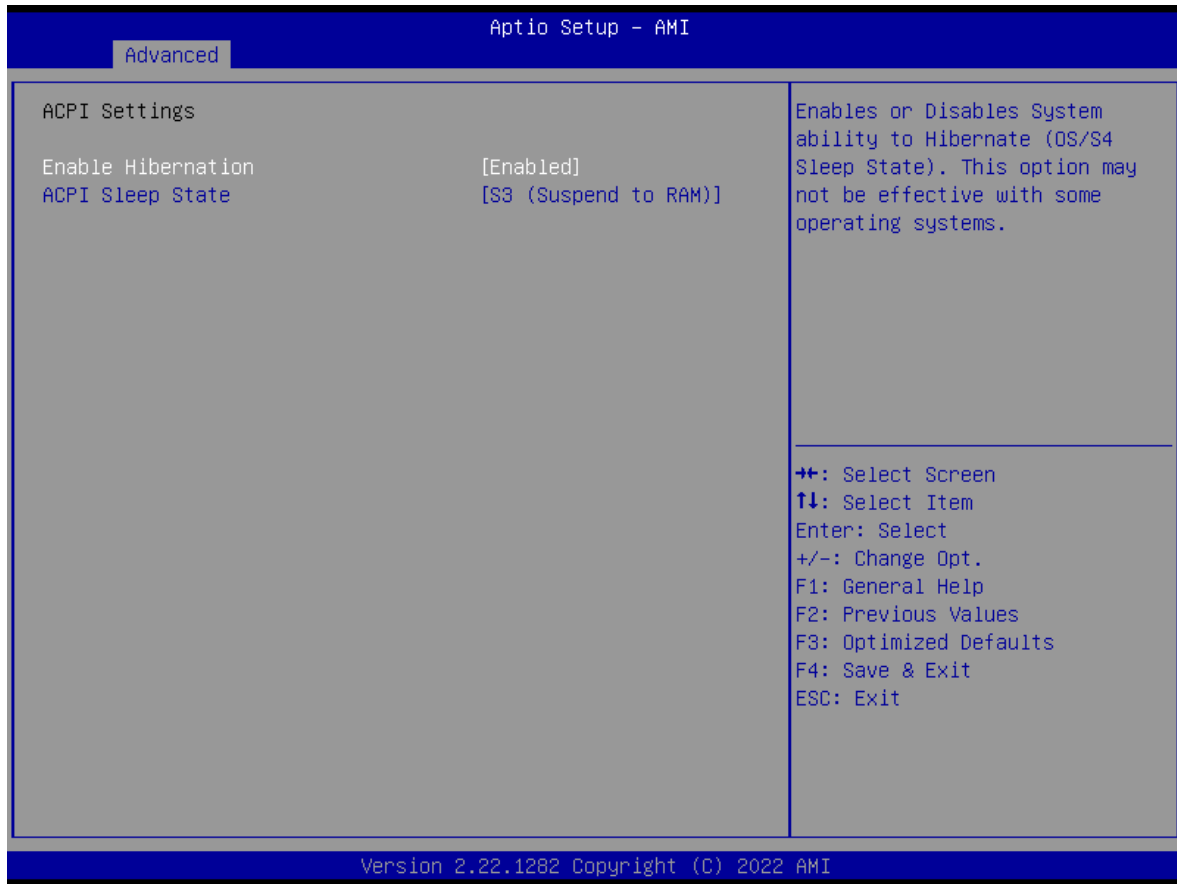

Item	Options	Description
<b>Enable Hibernation</b>	Disabled , Enabled[ <b>Default</b> ],	Enables or Disables System ability to Hibernate (OS/S4 Sleep State). This option may not be effective with some operating systems.
<b>ACPI Sleep State</b>	Suspend Disabled, S3 (Suspend to RAM)[ <b>Default</b> ]	Select the highest ACPI sleep state the system will enter when the SUSPEDN button is pressed.

### 4.3.6 Super IO Configuration

This setting allows you to select options for the Super IO Configuration, and change the value of the selected option.

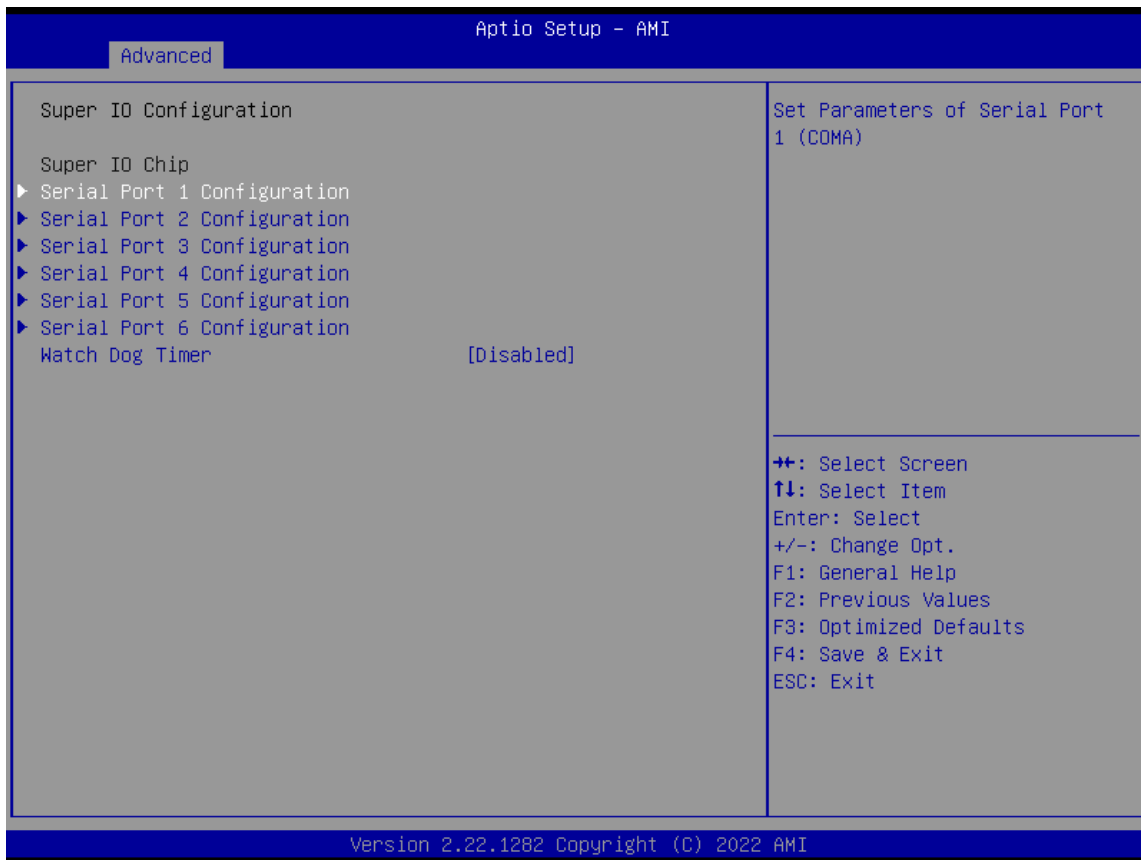

Item	Description
<b>Serial Port 1 Configuration</b>	Set Parameters of Serial Port 1 (COMA).
<b>Serial Port 2 Configuration</b>	Set Parameters of Serial Port 2 (COMB).
<b>Serial Port 3 Configuration</b>	Set Parameters of Serial Port 3 (COMC).
<b>Serial Port 4 Configuration</b>	Set Parameters of Serial Port 4 (COMD).
<b>Serial Port 5 Configuration</b>	Set Parameters of Serial Port 5 (COME).
<b>Serial Port 6 Configuration</b>	Set Parameters of Serial Port 6 (COMF).

Item	Options	Description
<b>Watch Dog Timer</b>	Disabled <b>[Default]</b> , Enabled	Enabled or Disabled Watch Dog Timer function.
<b>Watch Dog Timer Count Mode</b>	Second Mode <b>[Default]</b> , Minute Mode	Select Second Mode or Minute Mode.
<b>Watch Dog Timer Time out Value</b>	20~255(Second) <b>[Default]</b> , 1~255(Minute)	Watch Dog Timer Time out Value.



■ Serial Port 1 Configuration

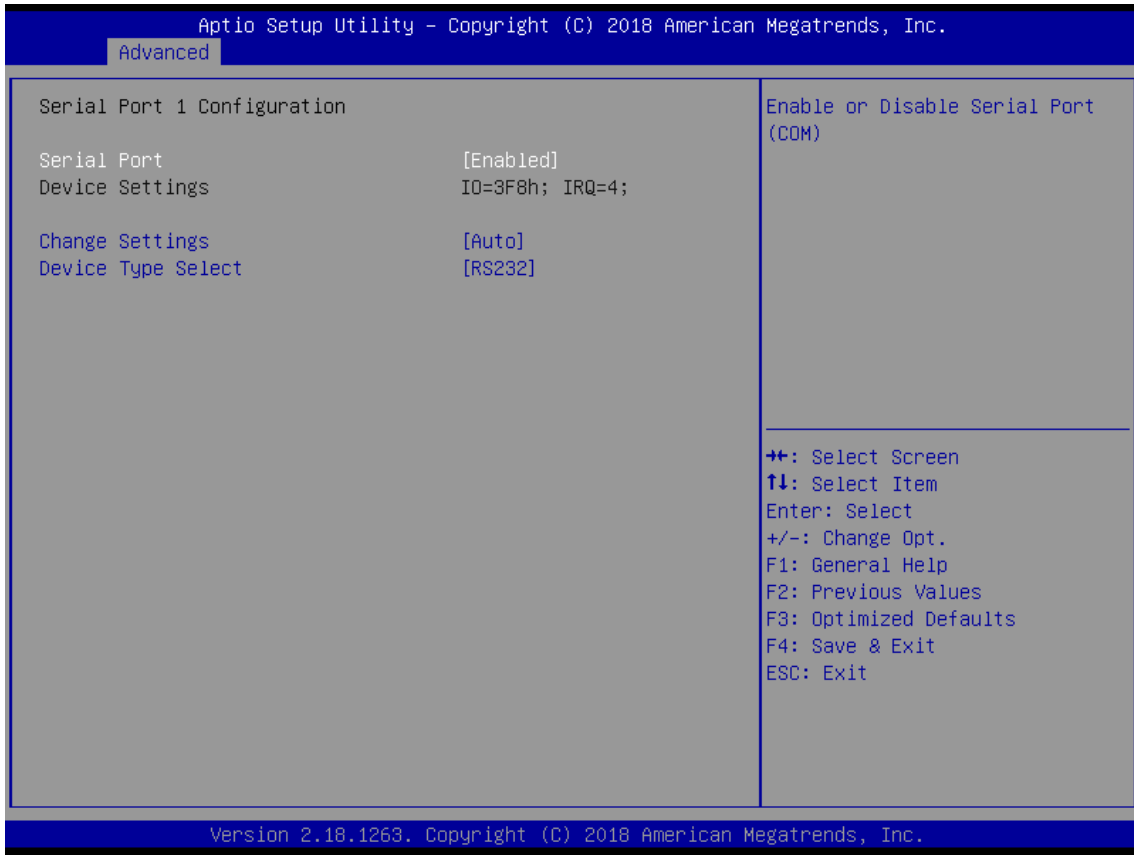

Item	Options	Description
<b>Serial Port</b>	Disabled, Enabled[Default]	Enable or Disable Serial Port (COM).
<b>Change Settings</b>	Auto[Default], IO=3F8h; IRQ=4; , IO=3F8h; IRQ=3,4,5,6,7,9,10,11,12; , IO=2F8h; IRQ=3,4,5,6,7,9,10,11,12;; IO=3E8h; IRQ=3,4,5,6,7,9,10,11,12;; IO=2E8h; IRQ=3,4,5,6,7,9,10,11,12;	This item allows you to change the address & IRQ settings of the specified serial port.
<b>Device Type Select</b>	UART 232[Default], UART 422, UART 485	Set the Serial Port to RS232 & RS422 & RS485
<b>RS-485 Auto Flow Function</b>	Disabled, Enabled[Default]	Enabled/Disabled RS485 Autoflow Function

■ Serial Port 2 Configuration



Item	Options	Description
<b>Serial Port</b>	Disabled, Enabled[Default]	Enable or Disable Serial Port (COM).
<b>Change Settings</b>	Auto[Default], IO=2F8h; IRQ=3; , IO=3F8h; IRQ=3,4,5,6,7,9,10,11,12; , IO=2F8h; IRQ=3,4,5,6,7,9,10,11,12;; IO=3E8h; IRQ=3,4,5,6,7,9,10,11,12;; IO=2E8h; IRQ=3,4,5,6,7,9,10,11,12;	This item allows you to change the address & IRQ settings of the specified serial port.
<b>Device Type Select</b>	UART 232[Default], UART 422, UART 485	Set the Serial Port to RS232 & RS422 & RS485
<b>RS-485 Auto Flow Function</b>	Disabled, Enabled[Default]	Enabled/Disabled RS485 Autoflow Function

■ Serial Port 3 Configuration

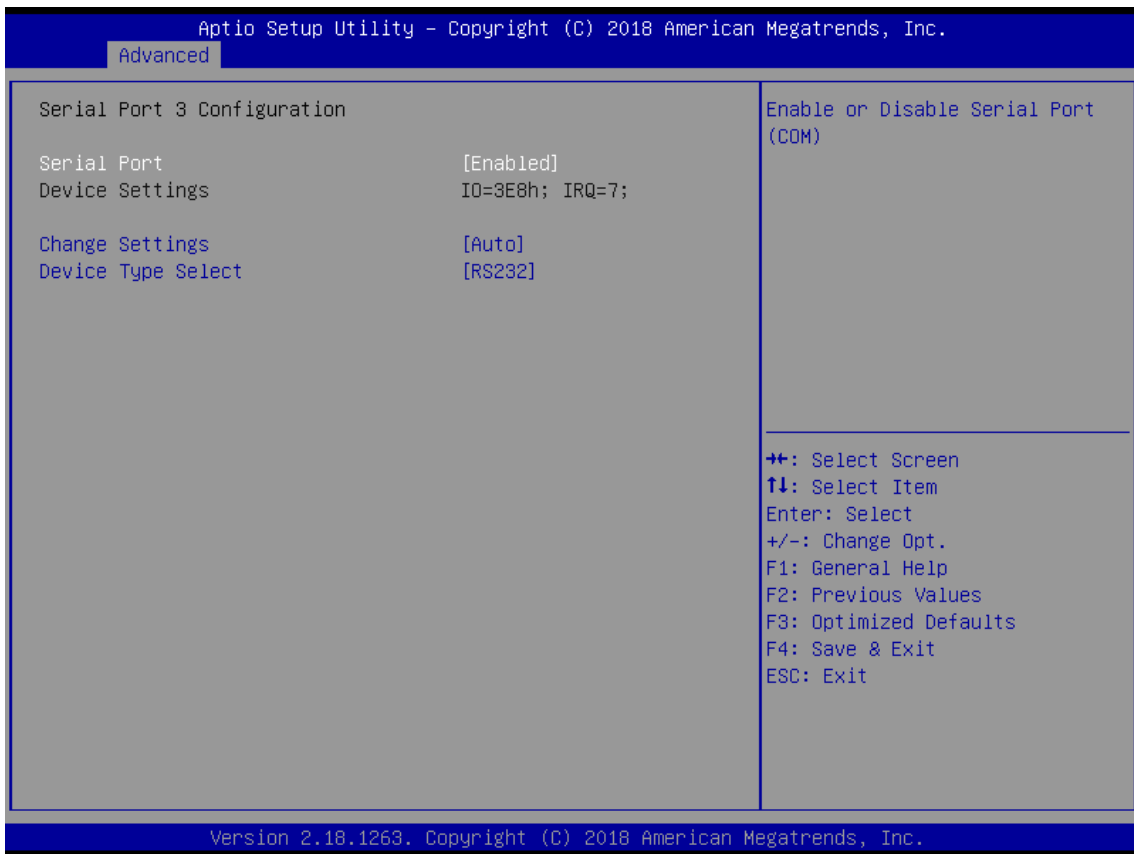

Item	Options	Description
Serial Port	Disabled, Enabled[Default]	Enable or Disable Serial Port (COM).
Change Settings	Auto[Default], IO=3E8h; IRQ=7; , IO=3E8h; IRQ=3,4,5,6,7,9,10,11,12; , IO=2E8h; IRQ=3,4,5,6,7,9,10,11,12;; IO=2F0h; IRQ=3,4,5,6,7,9,10,11,12;; IO=2E0h; IRQ=3,4,5,6,7,9,10,11,12;	This item allows you to change the address & IRQ settings of the specified serial port.
Device Type Select	UART 232[Default], UART 422, UART 485	Set the Serial Port to RS232 & RS422 & RS485
RS-485 Auto Flow Function	Disabled, Enabled[Default]	Enabled/Disabled RS485 Autoflow Function

■ Serial Port 4 Configuration

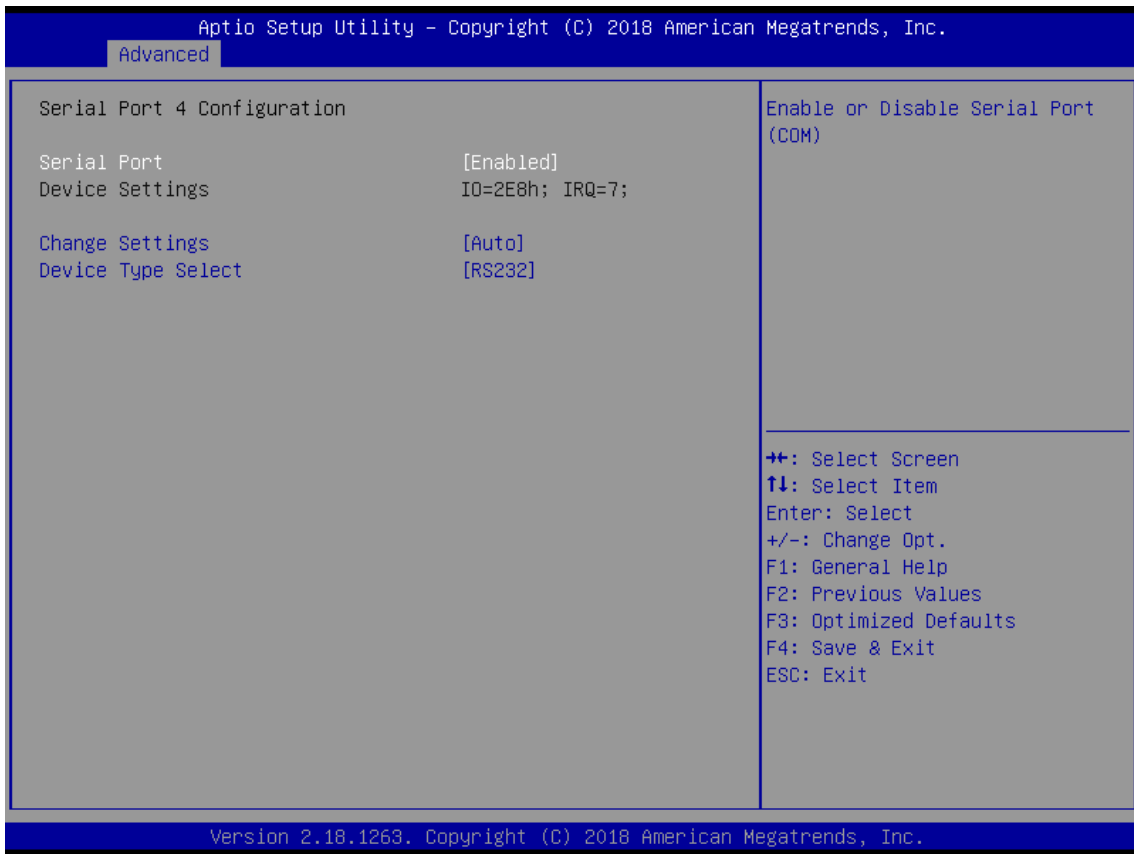

Item	Options	Description
Serial Port	Disabled, Enabled[Default]	Enable or Disable Serial Port (COM).
Change Settings	Auto[Default], IO=2E8h; IRQ=7; , IO=3E8h; IRQ=3,4,5,6,7,9,10,11,12; , IO=2E8h; IRQ=3,4,5,6,7,9,10,11,12;; IO=2F0h; IRQ=3,4,5,6,7,9,10,11,12;; IO=2E0h; IRQ=3,4,5,6,7,9,10,11,12;	This item allows you to change the address & IRQ settings of the specified serial port.
Device Type Select	UART 232[Default], UART 422, UART 485	Set the Serial Port to RS232 & RS422 & RS485
RS-485 Auto Flow Function	Disabled, Enabled[Default]	Enabled/Disabled RS485 Autoflow Function

■ Serial Port 5 Configuration



Item	Options	Description
<b>Serial Port</b>	Disabled, Enabled <b>[Default]</b>	Enable or Disable Serial Port (COM).
<b>Change Settings</b>	Auto <b>[Default]</b> , IO=2F0h; IRQ=7; , IO=3E8h; IRQ=3,4,5,6,7,9,10,11,12; , IO=2E8h; IRQ=3,4,5,6,7,9,10,11,12; , IO=2F0h; IRQ=3,4,5,6,7,9,10,11,12; , IO=2E0h; IRQ=3,4,5,6,7,9,10,11,12;	This item allows you to change the address & IRQ settings of the specified serial port.
<b>Device Type Select</b>	UART 232 <b>[Default]</b> , UART 422, UART 485	Set the Serial Port to RS232 & RS422 & RS485
<b>RS-485 Auto Flow Function</b>	Disabled, Enabled <b>[Default]</b>	Enabled/Disabled RS485 Autoflow Function

■ Serial Port 6 Configuration

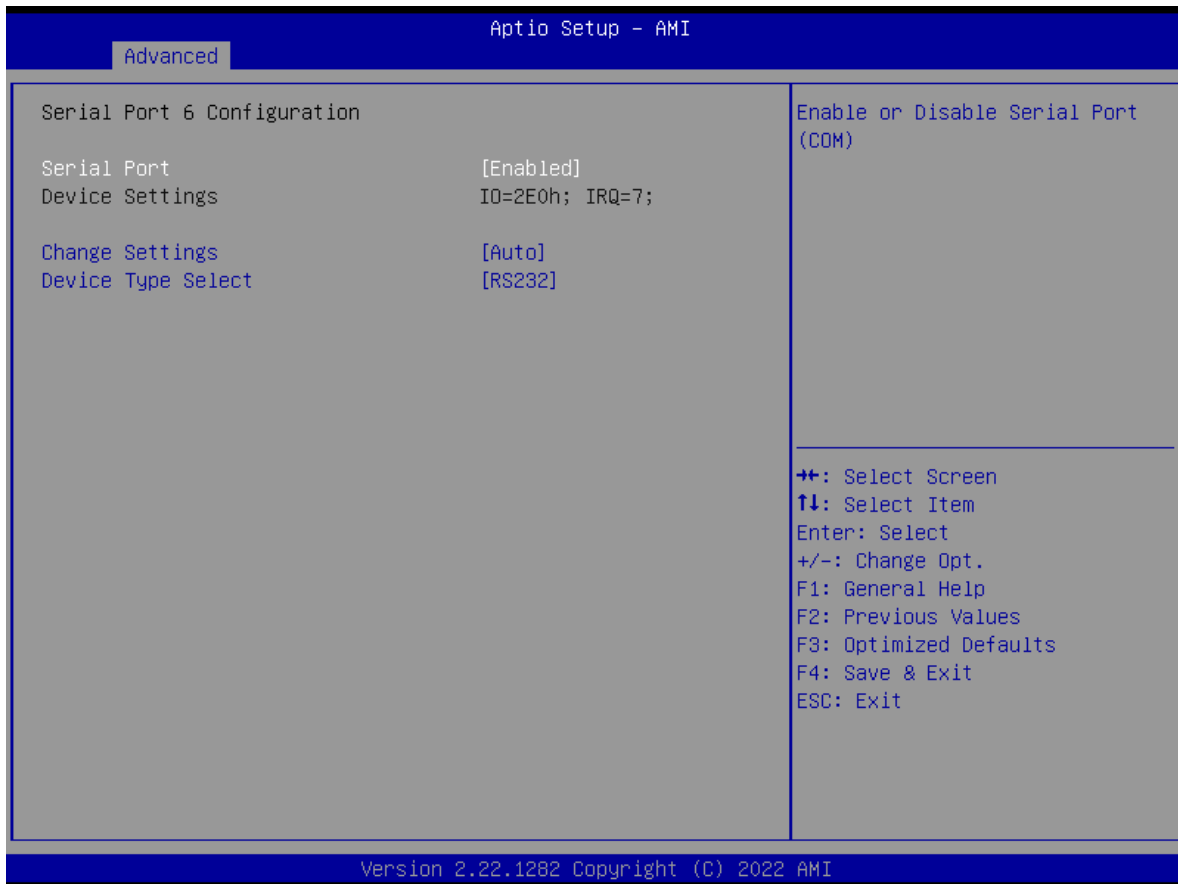

Item	Options	Description
<b>Serial Port</b>	Disabled, Enabled <b>[Default]</b>	Enable or Disable Serial Port (COM).
<b>Change Settings</b>	Auto <b>[Default]</b> , IO=2E0h; IRQ=7; , IO=3E8h; IRQ=3,4,5,6,7,9,10,11,12; , IO=2E8h; IRQ=3,4,5,6,7,9,10,11,12; , IO=2F0h; IRQ=3,4,5,6,7,9,10,11,12; , IO=2E0h; IRQ=3,4,5,6,7,9,10,11,12;	This item allows you to change the address & IRQ settings of the specified serial port.
<b>Device Type Select</b>	UART 232 <b>[Default]</b> , UART 422, UART 485	Set the Serial Port to RS232 & RS422 & RS485
<b>RS-485 Auto Flow Function</b>	Disabled, Enabled <b>[Default]</b>	Enabled/Disabled RS485 Autoflow Function

### 4.3.7 Hardware Monitor

These items display the current status of all monitored hardware devices/ components such as voltages and temperatures.

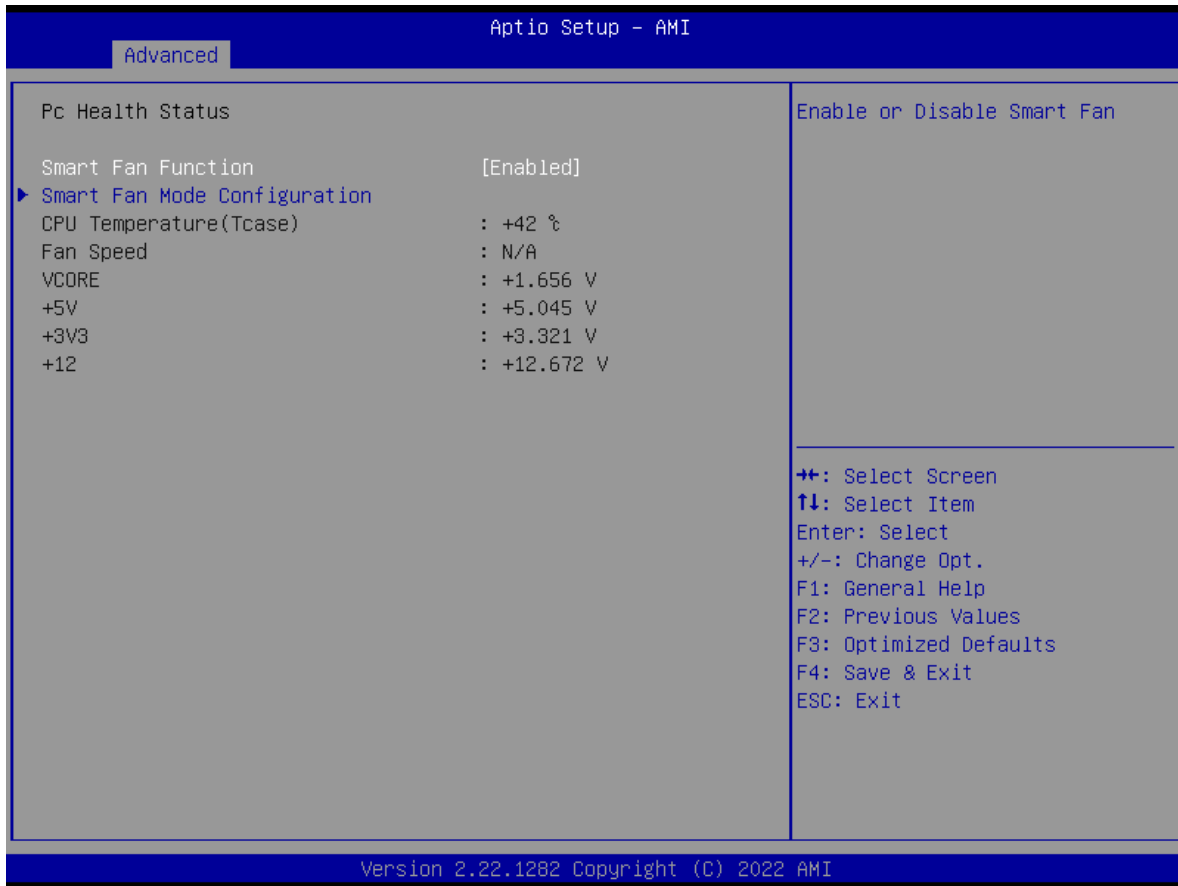

Item	Options	Description
<b>Smart Fan Function</b>	Disabled[Default], Enabled	Enabled or Disable Smart Fan

■ Smart Fan Mode Configuration

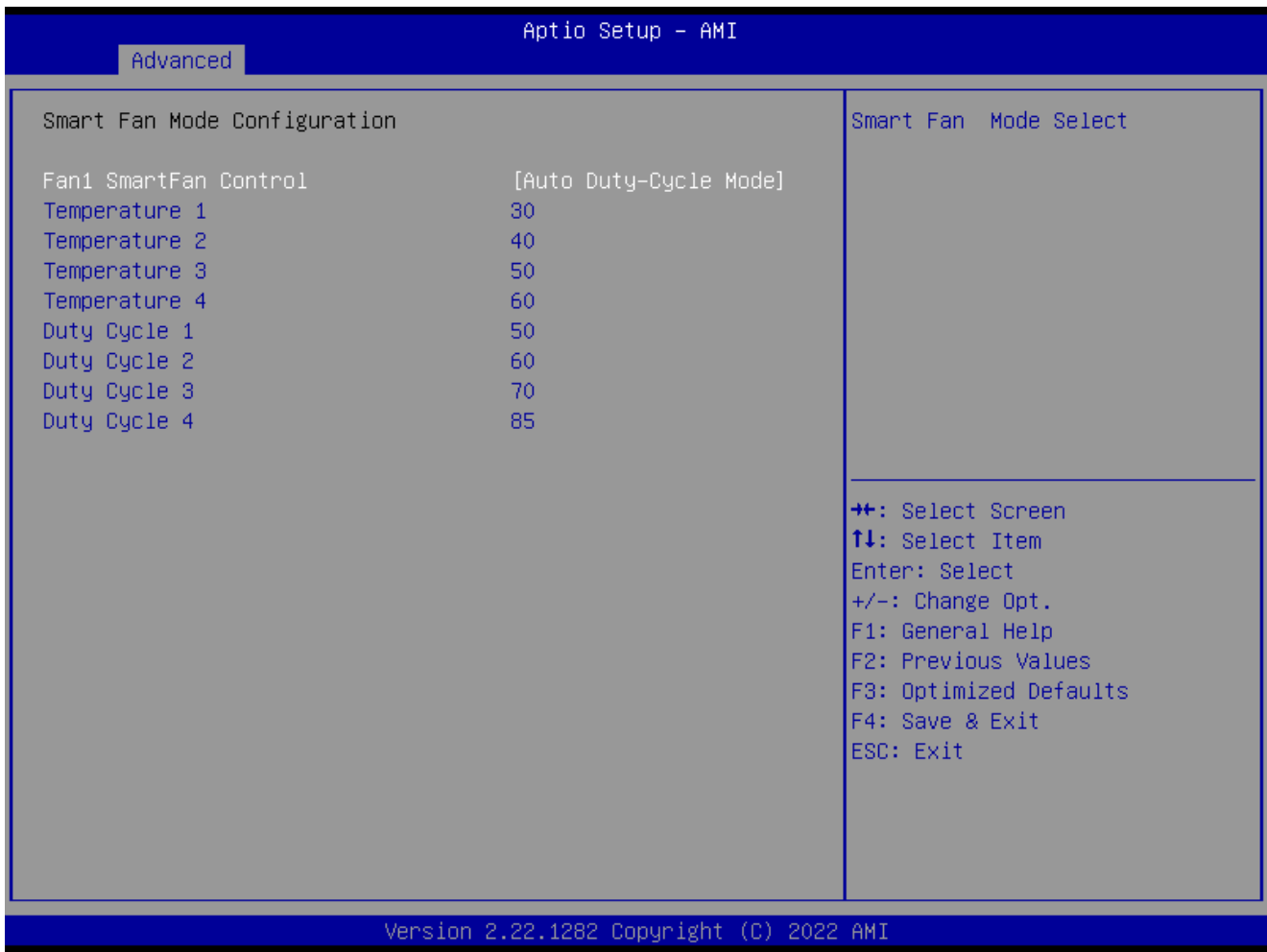

Item	Options	Description
<b>Fan1 SmartFan Control</b>	Manual Duty Mode, Auto Duty-Cycle Mode[ <b>Default</b> ],	Smart Fan Mode Select
<b>Temperature 1~4</b>	1~100	Auto fan speed control. SMART FAN IV
<b>Duty Cycle 1~4</b>	20~100	Auto fan speed control. SMART FAN IV



### 4.3.8 Power IGN Mode



Item	Options	Description
<b>IGN Setting</b>	Bypass mode[Default] Write IGN	Bypass: BIOS will not control IGN Module, Write IGN: BIOS will write setting to IGN module
<b>Power On Delay</b>	10 Sec[Default] 20 Sec 30 Sec 40 Sec 50 Sec 1 Min Manual Mode	Power On Delay Select
<b>Manual Mode</b>	10 Sec[Default]	10~60 Sec
<b>Power Off Delay</b>	3 Sec[Default] , 1 Min, 5 Min, 10 Min, 30 Min, 1 Hour, 2 Hour, Manual Mode	Power Off Delay Select
<b>Manual Mode</b>	3 Sec[Default]	3~7200 Sec

### 4.3.9 Serial Port Console Redirection

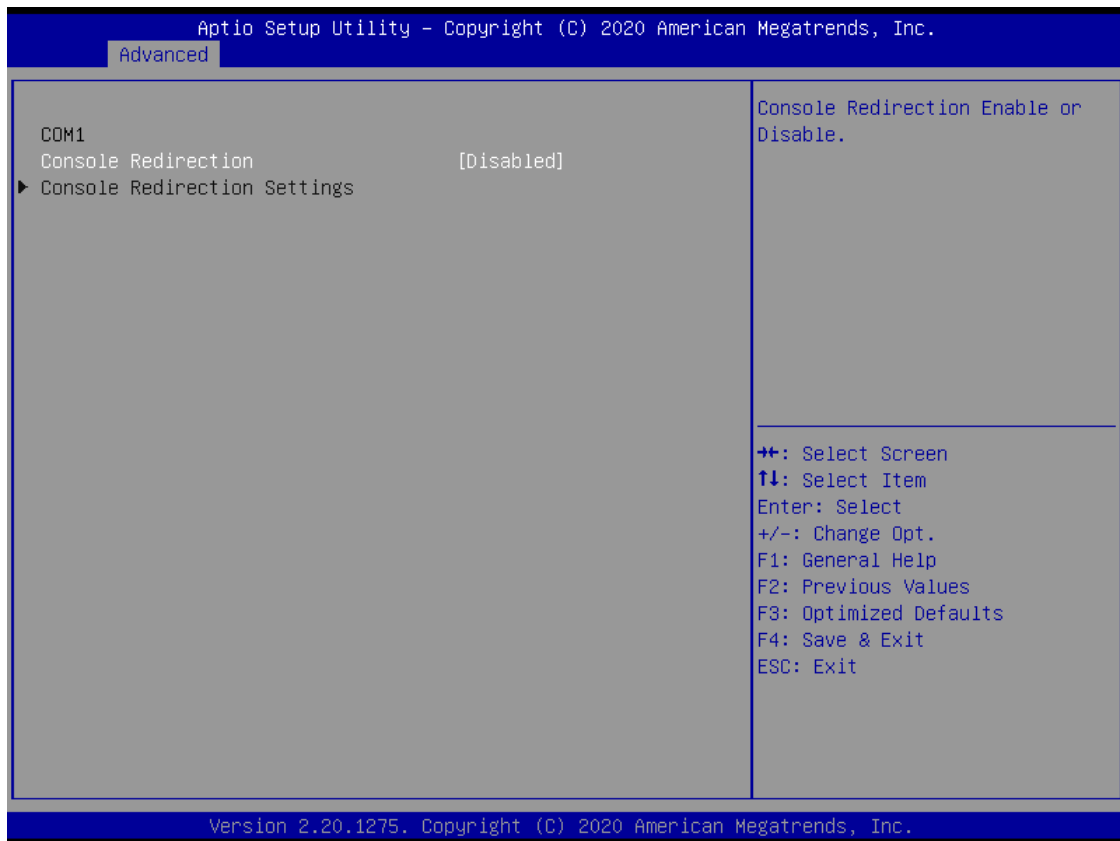

Item	Options	Description
<b>Console Redirection</b>	Disabled[Default], Enabled	These items allows you to enable or disable COM1 console redirection

## 4.3.10 USB Configuration



Item	Options	Description
<b>Legacy USB Support</b>	Enabled[Default] Disabled Auto	Enables Legacy USB support. AUTO option disables legacy support if no USB devices are connected. DISABLE option will keep USB devices available only for EFI applications.
<b>XHCI Hand-off</b>	Enabled[Default] Disabled	This is a workaround for OSeW without XHCI hand-off support. The XHCI ownership change should be claimed by XHCI driver.
<b>USB Mass Storage Driver Support</b>	Disabled Enabled[Default]	Enable/Disable USB Mass Storage Driver Support.
<b>USB transfer time-out</b>	1 sec , 5 sec , 10 sec , 20 sec[Default]	The time-out value for Control, Bulk, and Interrupt transfers.
<b>Device reset time-out</b>	10 sec , 20 sec[Default] , 30 sec, 40 sec	USB mass storage device Start Unit command time-out.
<b>Device power-up delay</b>	Auto[Default] Manual	Maximum time the device will take before it properly reports itself to the Host Controller. 'Auto' uses default value: for a Root port it is 100ms, for a Hub port the delay is taken from Hub descriptor.

### 4.3.11 Network Stack Configuration



Item	Options	Description
<b>Network Stack</b>	Disabled[Default], Enabled	Enable/Disable UEFI Network Stack.
<b>IPv4 PXE Support</b>	Disabled[Default], Enabled	Enable/Disable IPv4 PXE boot support. If disabled, IPv4 PXE boot support will not be available.
<b>IPv6 PXE Support</b>	Disabled[Default], Enabled	Enable/Disable IPv4 PXE boot support. If disabled, IPv6 PXE boot support will not be available.
<b>PXE boot wait time</b>	0[Default]	Wait time in seconds to press ESC key to abort the PXE boot. Use either +/- or numeric keys to set the value.
<b>Media detect count</b>	1[Default]	Number of times the presence of media will be checked. Use either +/- or numeric keys to set the value.

## 4.4 Chipset

This section allows you to configure and improve your system and allows you to set up some system features according to your preference.

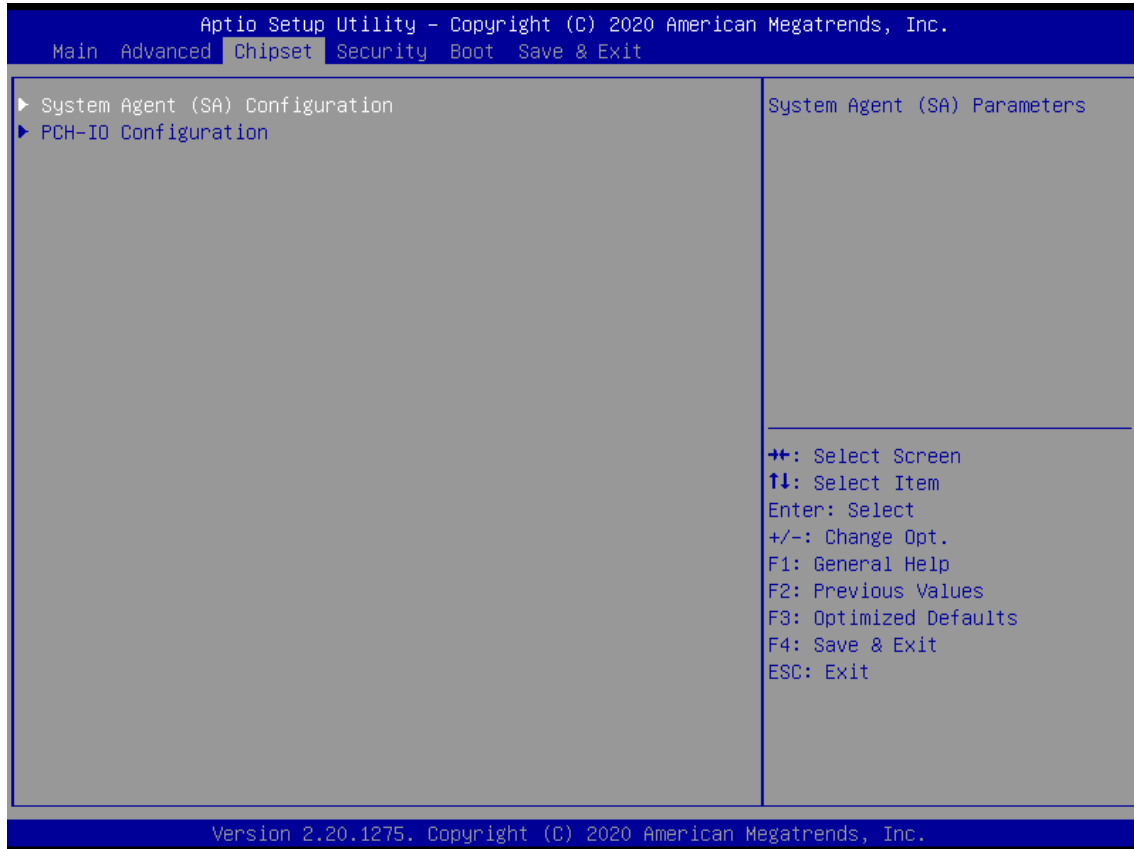

### 4.4.1 System Agent (SA) Configuration



Item	Options	Description
VT-d	Disabled, Enabled <b>[Default]</b>	VT-d capability.
<b>Above 4GB MMIO BIOS assignment</b>	Enabled <b>[Default]</b> , Disabled	Enable/Disable above 4GB MemoryMappedIO BIOS assignment\n\nThis is enabled automatically when Aperture Size is set to 2048MB.

■ Memory Configuration

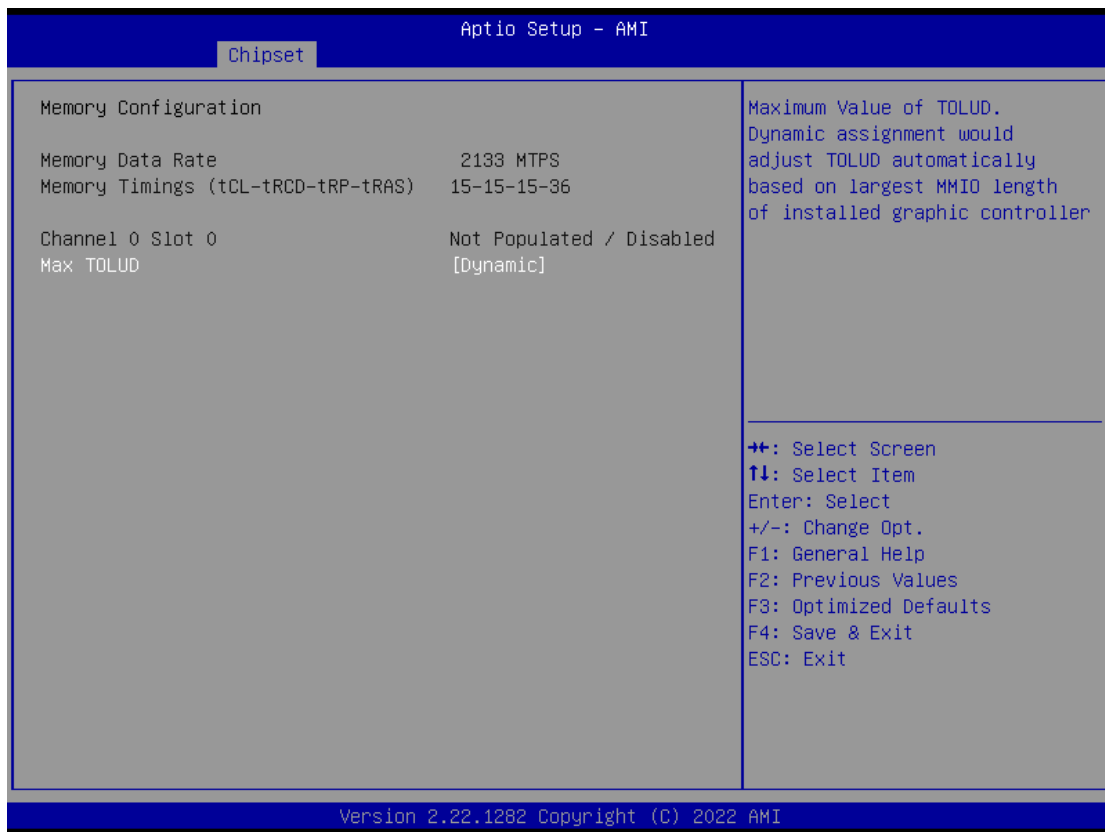

Item	Options	Description
<b>Max TOLUD</b>	Dynamic[Default], 1GB, 1.25GB, 1.5 GB, 1.75 GB, 2 GB, 2.25 GB, 2.5 GB,	Maximum Value of TOLUD. Dynamic assignment would adjust TOLUD automatically based on largest MMIO length of installed graphic controller

## ■ Graphic Configuration

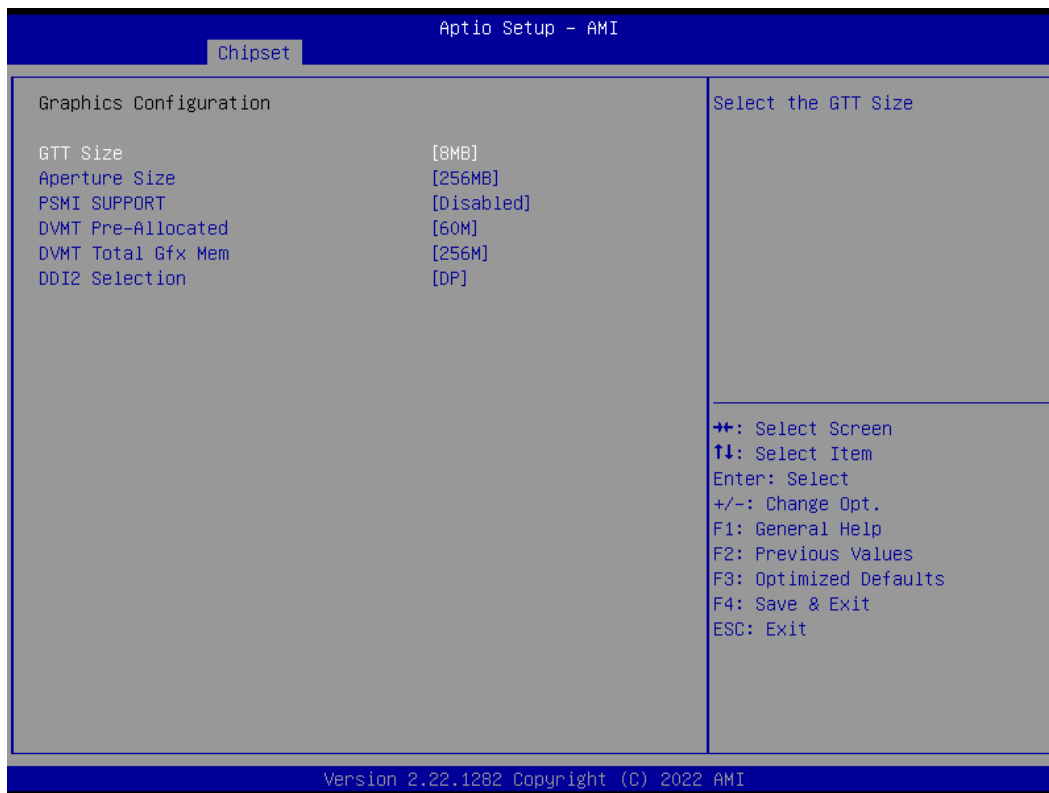

Item	Options	Description
<b>GTT Size</b>	2MB, 4MB, 8MB[Default]	Select the GTT Size .
<b>Aperture Size</b>	128MB, 256MB[Default] , 512MB, 1024MB	Select the Aperture Size.  Note : Above 4GB MMIO BIOS assignment is automatically enabled when selecting 2048MB aperture. To use this feature, please disable CSM Support.
<b>PSMI SUPPORT</b>	Disabled [Default] , Enabled	PSMI Enable/Disable.
<b>DVMT Pre-Allocated</b>	32M,64M,96M,128M, 160M,4M, 8M,12M, 16M,20M,24M, 28M, 32M/F7,36M, 40M,44M, 48M,52M,56M, 60M[Default]	Select DVMT 5.0 Pre-Allocated (Fixed) Graphics Memory size used by the Internal Graphics Device.
<b>DVMT Total Gfx Mem</b>	128M, 256M[Default] , MAX	Select DVMT5.0 Total Graphic Memory size used by the Internal Graphics Device.
<b>DDI2 Selection</b>	DP[Default] , HDMI	Selects DDI2 function: DP or HDMI



## 4.4.2 PCH-IO Configuration

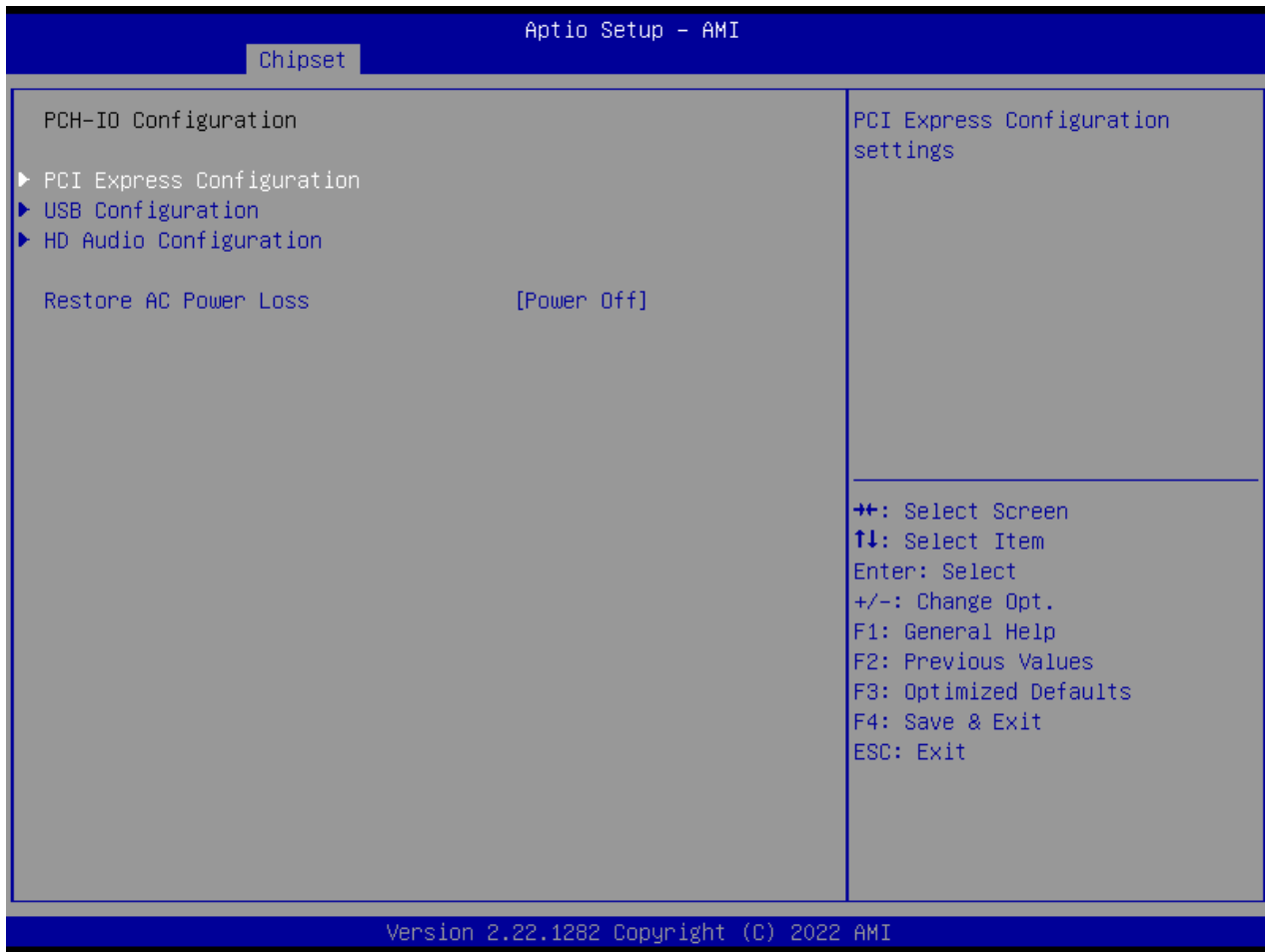

Item	Options	Description
<b>Restore AC Power Loss</b>	Power On, Power Off <b>[Default]</b> , Lase State	Specify what state to go to when power is re-applied after a power failure (G3 state).

## ■ PCI Express Configuration

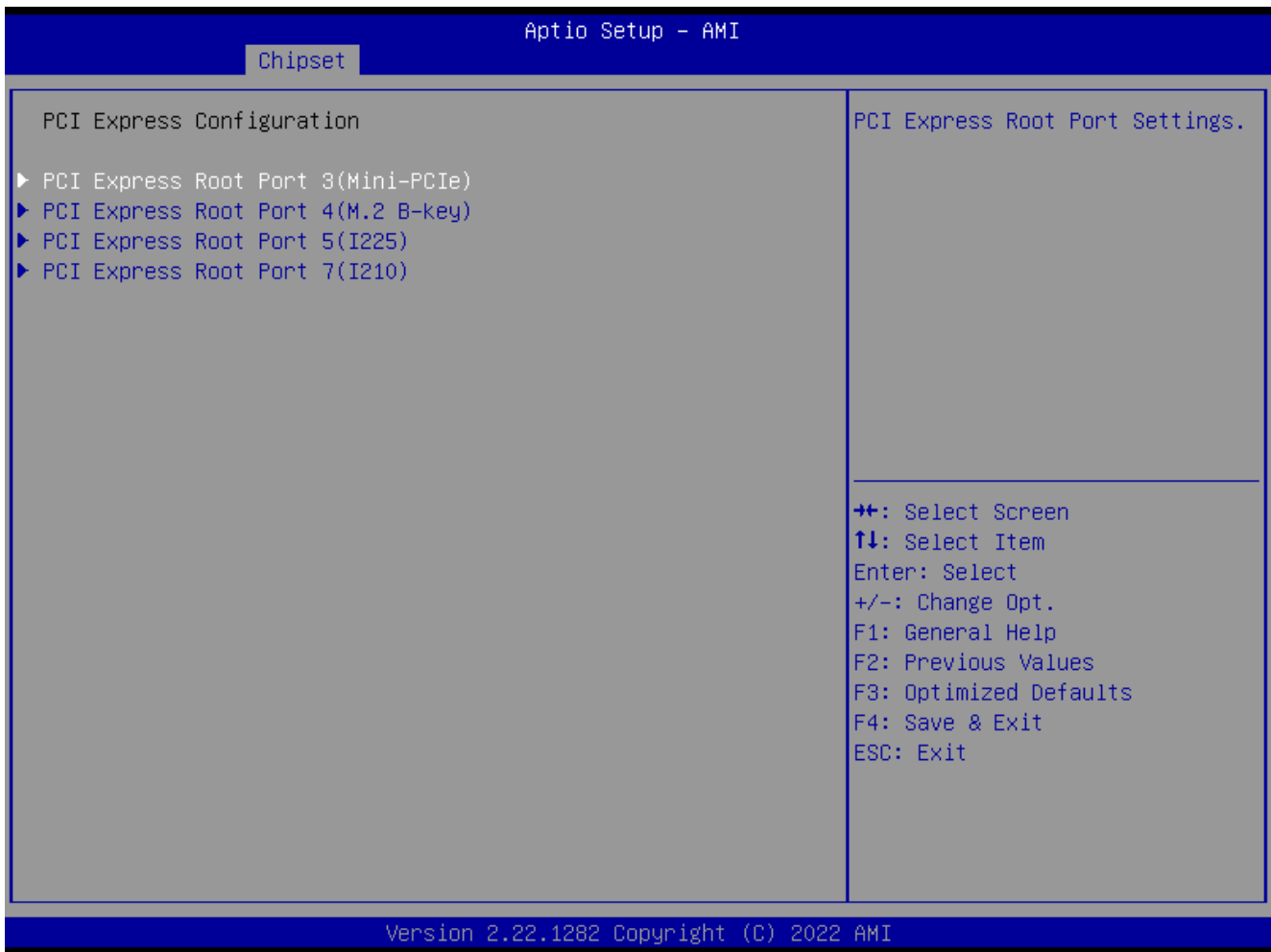

■ PCI Express Root Port 3 /4 /5 /7



Item	Options	Description
<b>PCI Express Root Port 3 /4 /5 /7</b>	Disabled, Enabled <b>[Default]</b>	Control the PCI Express Root Port.
<b>ASPM</b>	Disabled <b>[Default]</b> , L0s, L1, L0sL1, Auto	Set the ASPM Level: Force L0s - Force all links to L0s State, AUTO - BIOS auto configure, DISABLE - Disables ASPM,
<b>PCIe Speed</b>	Auto <b>[Default]</b> , Gen1, Gen2, Gen3	Configure PCIe speed.
<b>Detect Non-Compliance Device</b>	Disabled <b>[Default]</b> , Enabled	Detect Non-Compliance PCI Express Device. If enable, it will take more time at POST time.

■ USB Configuration

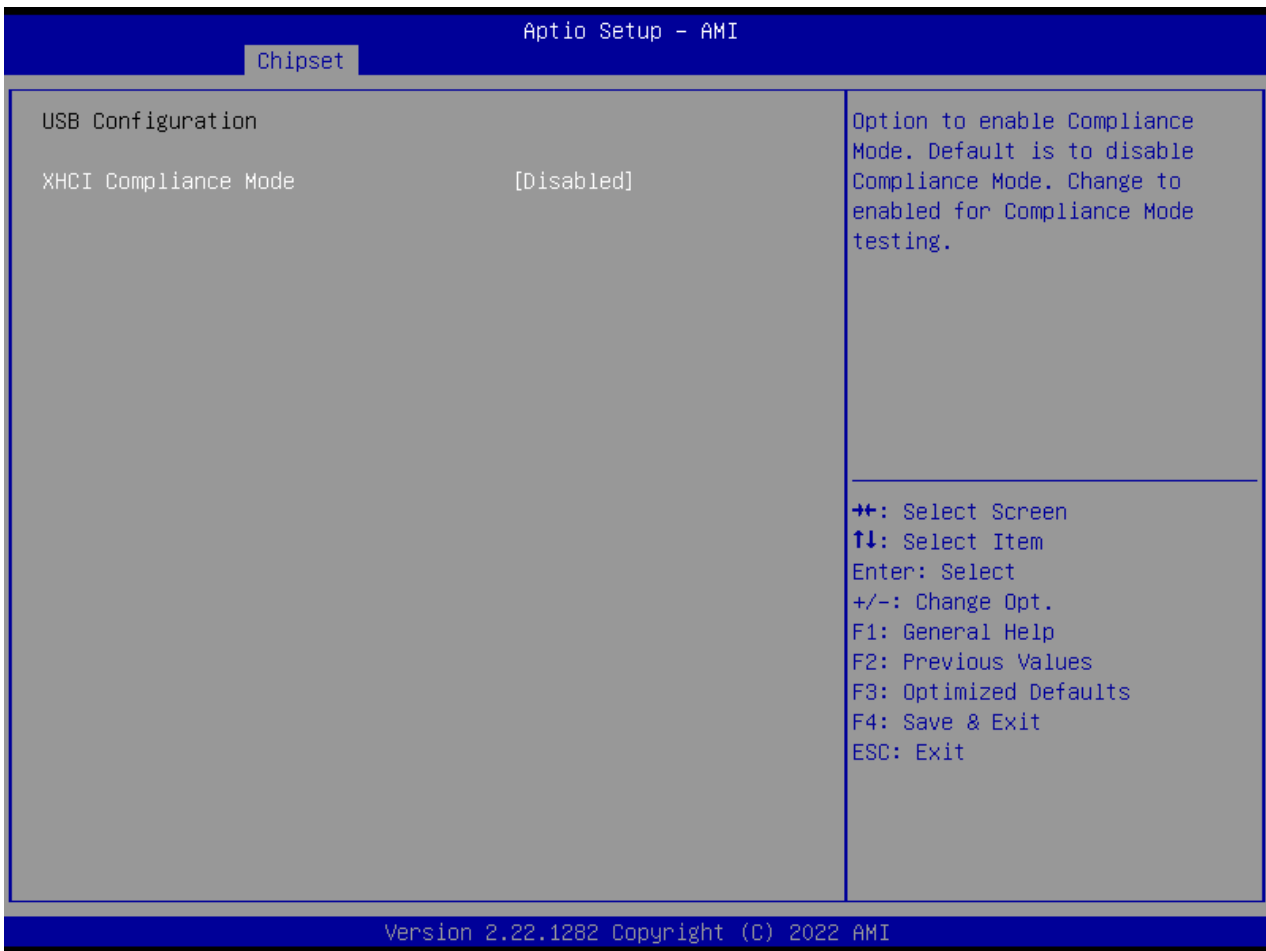

Item	Options	Description
XHCI Compliance mode	Disabled <b>[Default]</b> , Enabled	Option to enable Compliance Mode. Default is to disable Compliance Mode. Change to enabled for Compliance Mode testing.

■ HD Audio Configuration

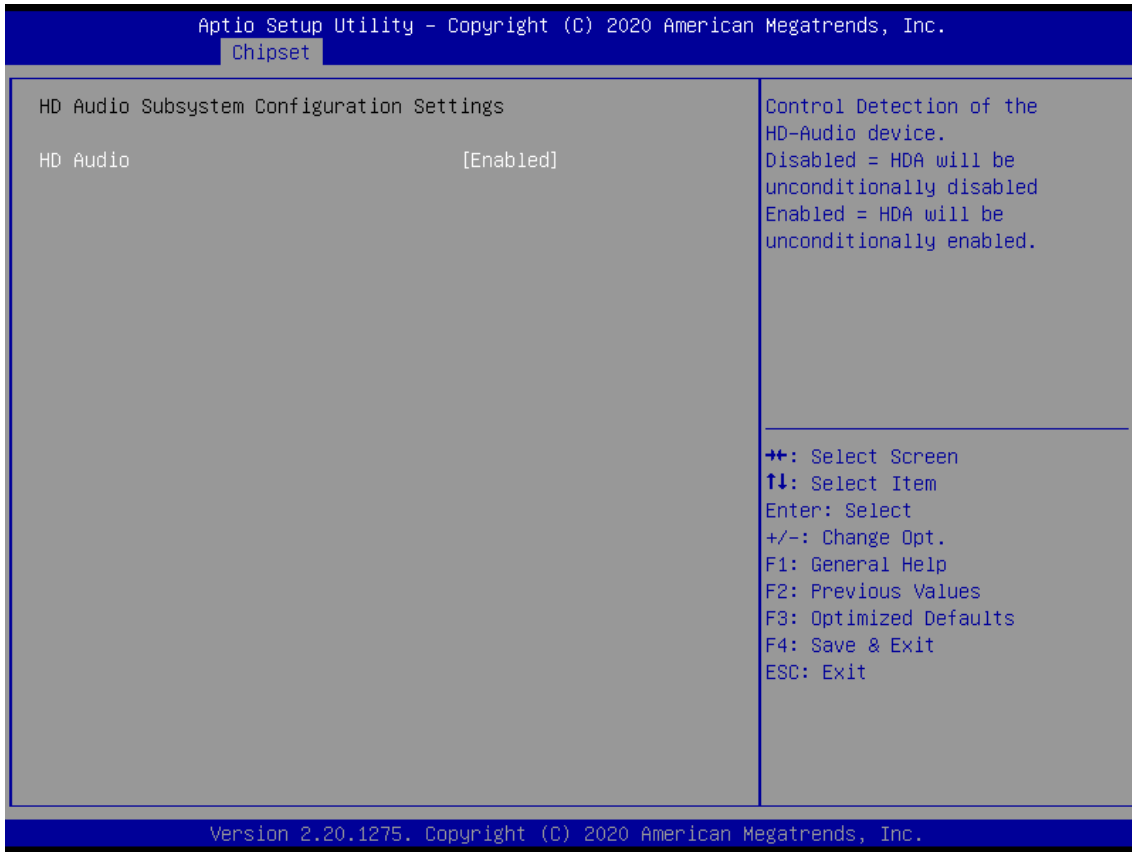

Item	Options	Description
HD Audio	Disabled, Enabled <b>[Default]</b>	Control Detection of the HD-Audio device.  Disabled = HDA will be unconditionally disabled  Enabled = HDA will be unconditionally enabled.

## 4.5 Security

Security menu allow users to change administrator password and user password settings.

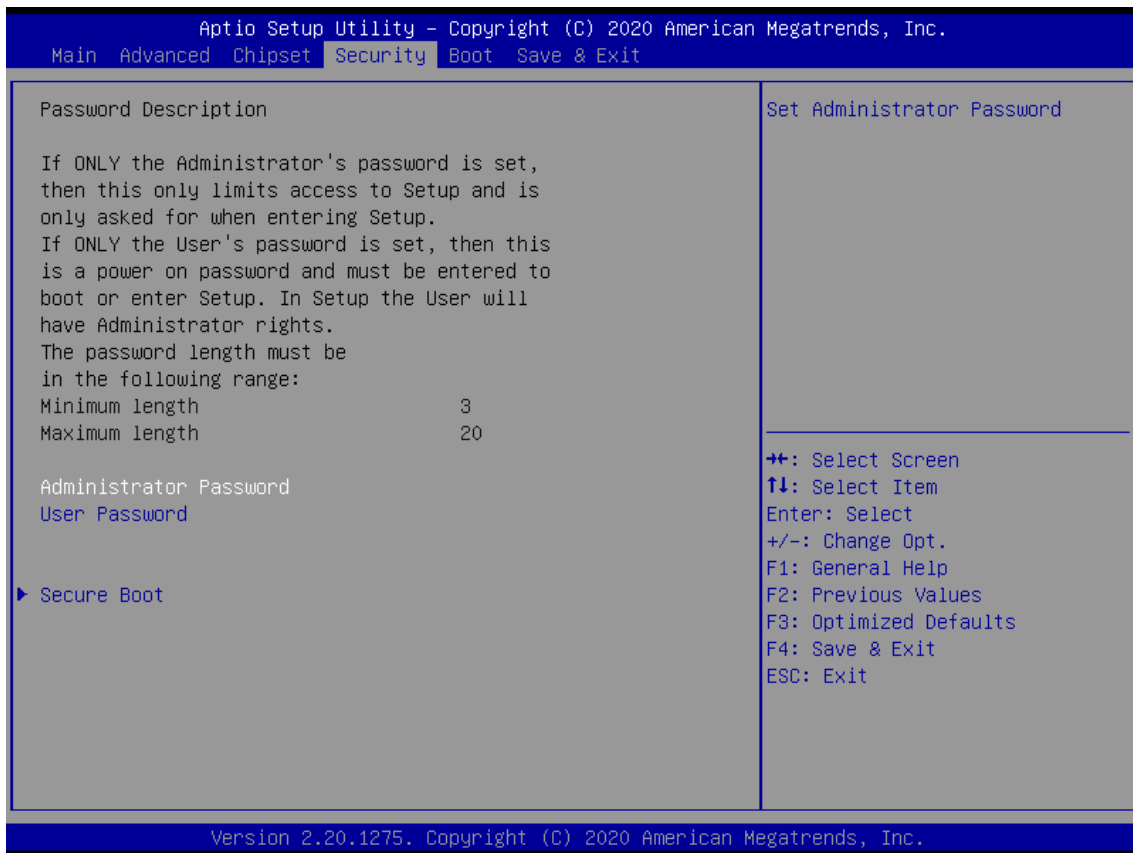

### ■ Administrator Password

This item allows you to set Administrator Password.

### ■ User Password

This item allows you to set User Password.

■ Security Boot

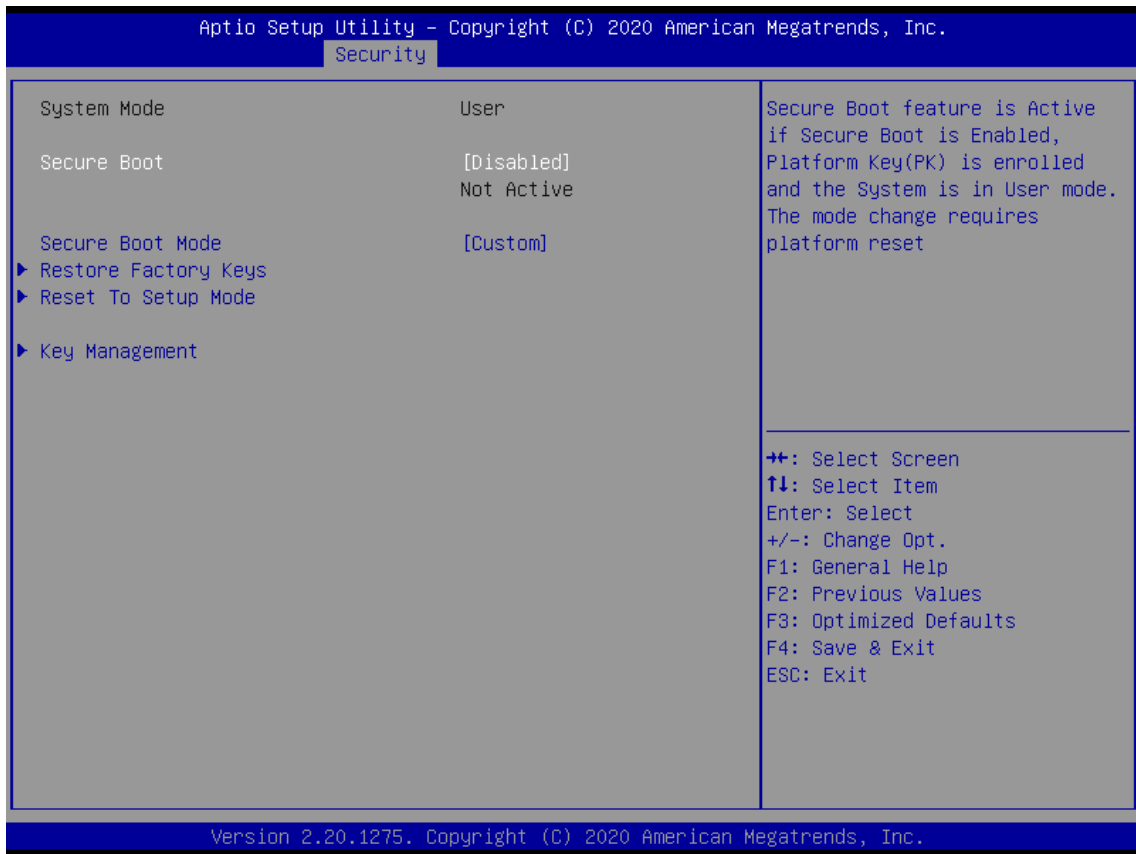

Item	Options	Description
Secure Boot	Disabled <b>[Default]</b> , Enabled	Secure Boot feature is Active if Secure Boot is Enabled, Platform Key(PK) is enrolled and the System is in User mode.  The mode change requires platform reset
Secure Boot Mode	Standard, Custom <b>[Default]</b>	Secure Boot mode options: Standard or Custom.  In Custom mode, Secure Boot Policy variables can be configured by a physically present user without full authentication

■ Key Management

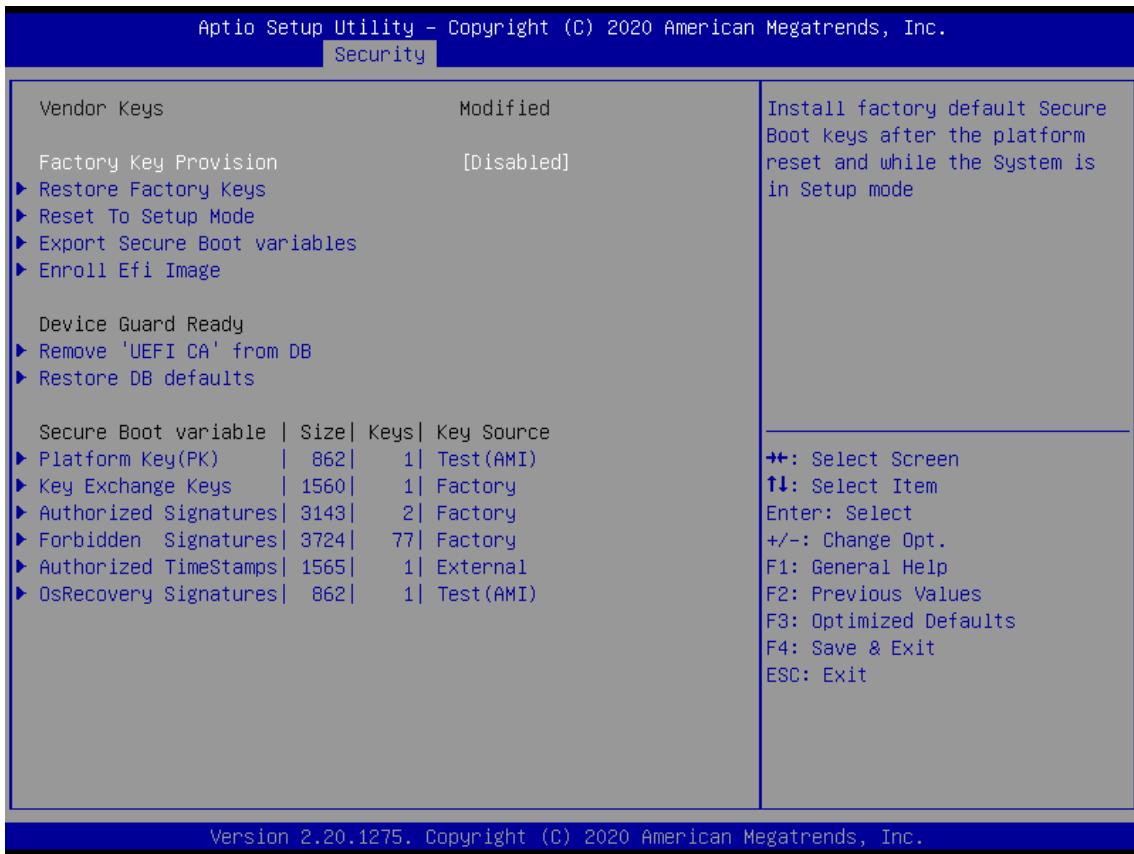

Item	Options	Description
Factory Key Provision	Disabled <b>[Default]</b> , Enabled	Install factory default Secure Boot keys after the platform reset and while the System is in Setup mode



## 4.6 Boot

This menu allows you to setup the system boot options.

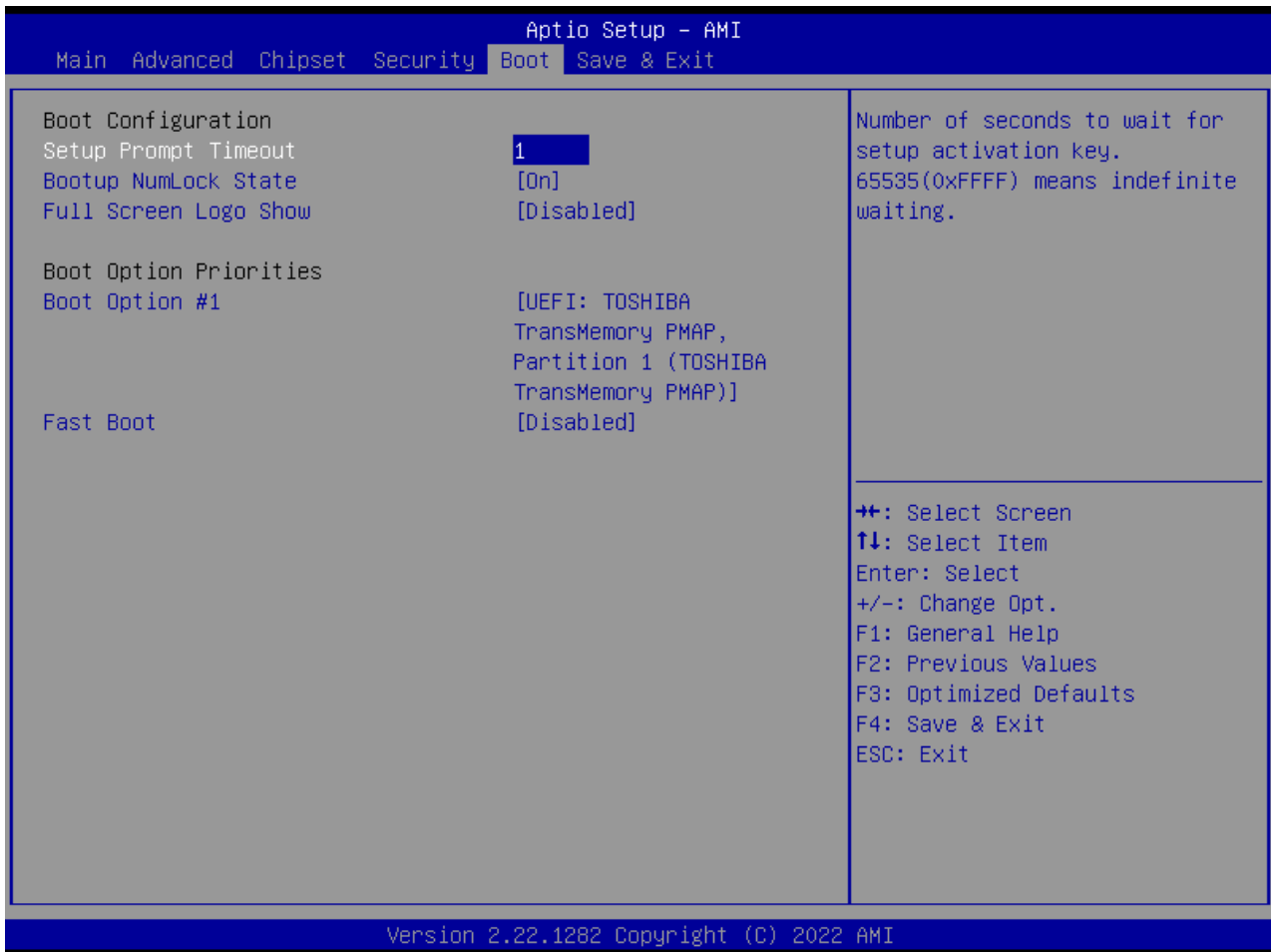

Item	Options	Description
<b>Setup Prompt Timeout</b>	1[Default]	Number of seconds to wait for setup activation key. 65535(0xFFFF) means indefinite waiting.
<b>Bootup NumLock State</b>	On[Default], Off	Select the Keyboard NumLock state.
<b>Full Screen Logo Show</b>	Disabled[Default], Enabled	Enables or disables Full Screen Logo Show option.
<b>Fast Boot</b>	Disabled[Default], Enabled	Enables or disables boot with initialization of a minimal set of devices required to launch active boot option. Has no effect for BBS boot options.
<b>Boot Option #1</b>		Set the system boot order.

## 4.7 Save & Exit

This setting allows users to configure the boot settings.



### ■ Save Changes and Reset

This item allows user to reset the system after saving the changes. This item allows user to reset the system after saving the changes.

### ■ Discard Changes and Reset

This item allows user to reset the system without saving any changes.

### ■ Restore Defaults

Use this item to restore /load default values for all the setup options.

# Appendix

## WDT & GPIO

This appendix provides the sample codes of WDT (Watch Dog Timer) and GPIO (General Purpose Input/ Output).

## WDT Sample Code

### WDT Setting

#### **Pseudo Code**

```
// IO Address 0xA16 is time value
```

```
// IO Address 0xA15 is WDT enable and configuration
```

Example, Set 0xA16=0x03, 0xA15=0x31, it will reset after 3 seconds

```
#define TimePort      0xA16
```

```
#define TimeEnablePort 0xA15
```

```
WriteByte (TimePort,0x03)
```

```
WriteByte (TimeEnablePort,0x31)
```

## GPIO Sample Code

### GPIO Setting

IO_DO4	I/O 0xA02h Bit3
IO_DO3	I/O 0xA02h Bit2
IO_DO2	I/O 0xA02h Bit1
IO_DO1	I/O 0xA02h Bit0
IO_DI4	I/O 0xA03h Bit7
IO_DI3	I/O 0xA03h Bit6
IO_DI2	I/O 0xA03h Bit5
IO_DI1	I/O 0xA03h Bit4

The GPIO function is provided by SIO, and it can be accessed through its GPIO port. To access the GPIO register, write value to data port. The configuration on the RCO1000-EHL is described as below.

### Pseudo Code

```
#define GPI_ADDR 0xA03h
```

```
#define GPO_ADDR 0xA02h
```

```
// 0xA03h is Pin Status(default 0xF5 )(at IO_DI1(Bit4) ~ IO_DI4(Bit7))
```

```
ByteData = ReadByte (GPI_ADDR) //Read current Pin Status
```

```
//Offset 0xA02h default setting is 0x5F (output pin set to output high) (at IO_DO1(Bit0) ~ IO_DO4(Bit3))
```

```
ByteData = 0x0F //set IO_DO1~ IO_DO4 to high
```

```
WriteByte (GPO_ADDR, ByteData)
```

