

USER'S MANUAL

RCO-1000 Series Compact Fanless Embedded System



Table of Contents

Prefaces	04
Revision	04
Disclaimer	04
Copyright Notice	04
Trademarks Acknowledgment	04
Environmental Protection Announcement	04
Safety Precautions	05
Technical Support and Assistance	06
Conventions Used in this Manual	06
Package Contents	07
Ordering Information	07
Optional Accessory	08
Chapter 1 Product Introductions	09
1.1 Overview	10
1.1.1 Key Feature	10
1.2 Hardware Specification	11
1.3 System I/O	12
1.3.1 RCO-1000	12
1.3.2 RCO-1010 / RCO-1010A / RCO-1010B	13
1.3.3 RCO-1020C / RCO-1020D	14
1.3.4 RCO-1030	16
1.4 Mechanical Dimension	18
1.4.1 RCO-1000	18
1.4.2 RCO-1010 / RCO-1010A / RCO-1010B	19
1.4.3 RCO-1020C / RCO-1020D	20
1.4.4 RCO-1030	21
Chapter 2 Jumpers and Connectors	22
2.1 Switch and connector Locations	23
2.1.1 Top View	23
2.1.2 Bottom View	24
2.1.3 Daughterboard view	24
2.2 Connector / Switch Definition	25
2.3 Switch Definitions	26
2.4 Connector Definitions	26
Chapter 3 System Setup	35
3.1 Set torque force to 3.5 kgf-cm to execute all the screwing and unscrewing	36
3.2 Removing chassis bottom cover	36
3.3 Removing HDD bracket	37
3.4 Removing chassis top cover	38
3.5 Installing SODIMM	39
3.6 Installing Mini PCIe card / mSATA	40
3.7 Installing antenna	41
3.8 Assemble chassis top cover	43
3.9 Installing SATA HDD	45
3.10 Assemble chassis bottom cover	47
3.11 Installing SIM card	48

3.12	Installing wall mount kit	50
3.13	Installing VESA mount kit	51
3.14	Installing side mount kit	53
3.15	Installing DIN rail holder	55
Chapter 4	BIOS Setup	56
4.1	BIOS Introduction	57
4.2	Main Setup	58
4.2.1	System Date	58
4.2.2	System Time	58
4.3	Advanced Setup	59
4.3.1	ACPI Settings	59
4.3.2	Super IO Configuration	60
4.3.3	Hardware Monitor	64
4.3.4	Serial Port Console Redirection	64
4.3.5	CPU Configuration	65
4.3.6	PPM Configuration	66
4.3.7	SATA Configuration	67
4.3.8	OS Selection	67
4.3.9	Compatibility Support Module Configuration	68
4.3.10	USB Configuration	69
4.4	Chipset	70
4.4.1	North Bridge	70
4.4.2	South Bridge	72
4.5	Security	74
4.5.1	Administrators Password	74
4.5.2	Users Password	74
4.6	Boot	75
4.6.1	Setup Prompt Timeout	75
4.6.2	Bootup NumLock State	75
4.6.3	Full Screen Logo Show	75
4.6.4	Boot Option Priorities	75
4.7	Save & Exit	76
4.7.1	Save Changes and Reset	76
4.7.2	Discard Changes and Reset	76
4.7.3	Restore Defaults	76
4.7.4	Save as User Defaults	76
4.7.5	Restore User Defaults	76
Appendix WDT & GPIO	77
	WDT Sample Code	78
	GPIO Sample Code	79

Prefaces

Revision

Revision	Description	Date
1.0	Manual Released	2017/10/26
1.1	Power Connector Definition Revised	2017/11/02
1.2	WDT & GPIO Sample Code Revised	2018/11/27
1.3	WDT & GPIO Sample Code Revised	2019/07/31
1.4	Connector Definition Revised	2019/11/01

Disclaimer

All specifications and information in this User's Manual are believed to be accurate and up to date. C&T Solution Inc. does not guarantee that the contents herein are complete, true, accurate or non-misleading. The information in this document is subject to change without notice and does not represent a commitment on the part of C&T Solution Inc.

C&T Solution Inc. disclaims all warranties, express or implied, including, without limitation, those of merchantability, fitness for a particular purpose with respect to contents of this User's Manual. Users must take full responsibility for the application of the product.

Copyright Notice

All rights reserved. No part of this manual may be reproduced or transmitted in any form or by any means, electronic or mechanical, including photocopying, recording, or information storage and retrieval systems, without the prior written permission of C&T Solution Inc. Copyright © C&T Solution Inc.

Trademarks Acknowledgment

Intel®, Celeron® and Pentium® are trademarks of Intel Corporation.

Windows® is registered trademark of Microsoft Corporation.

AMI is trademark of American Megatrend Inc.

IBM, XT, AT, PS/2 and Personal System/2 are trademarks of International Business Machines Corporation

All other products and trademarks mentioned in this manual are trademarks of their respective owners.

Environmental Protection Announcement

Do not dispose this electronic device into the trash while discarding. Please recycle to minimize pollution and ensure environment protection.



Safety Precautions

Before installing and using the equipment, please read the following precautions:

- Put this equipment on a reliable surface during installation. Dropping it or letting it fall could cause damage.
- The power outlet shall be installed near the equipment and shall be easily accessible.
- Turn off the system power and disconnect the power cord from its source before making any installation. Be sure both the system and the external devices are turned OFF. Sudden surge
- of power could ruin sensitive components. Make sure the equipment is properly grounded.
- When the power is connected, never open the equipment. The equipment should be opened only by qualified service personnel.
- Make sure the voltage of the power source is correct before connecting the equipment to the power outlet.
- Disconnect this equipment from the power before cleaning. Use a damp cloth. Do not use liquid or spray detergents for cleaning.
- Avoid the dusty, humidity and temperature extremes.
- Do not place heavy objects on the equipment.
- If the equipment is not used for long time, disconnect it from the power to avoid being damaged by transient over-voltage.
- The storage temperature shall be above -40°C and below 85°C .
- The computer is provided with a battery-powered real-time clock circuit. There is a danger of explosion if incorrectly replaced. Replace only with the same or equivalent type recommended by the manufacturer.
- If one of the following situation arises, get the equipment checked by service personnel:
 - The power cord or plug is damaged.
 - Liquid has penetrated into the equipment.
 - The equipment has been exposed to moisture.
 - The equipment does not work well or it cannot work according the user's manual.
 - The equipment has been dropped and damaged.
 - The equipment has obvious signs of breakage.

Technical Support and Assistance

1. Visit the C&T Solution Inc website at <https://www.candtsolution.com/en/> where you can find the latest information about the product.
2. Contact your distributor, our technical support team or sales representative for technical support if you need additional assistance. Please have following information ready before you call:
 - Model name and serial number
 - Description of your peripheral attachments
 - Description of your software (operating system, version, application software, etc.)
 - A complete description of the problem
 - The exact wording of any error messages

Conventions Used in this Manual

**WARNING**

This indication alerts operators to an operation that, if not strictly observed, may result in severe injury.

**CAUTION**

This indication alerts operators to an operation that, if not strictly observed, may result in safety hazards to personnel or damage to equipment.

**NOTE**

This indication provides additional information to complete a task easily.

Package Contents

Before installation, please ensure all the items listed in the following table are included in the package.

Item	Description	Q'ty
1	RCO-1000 Series Embedded System	1
2	Wall Mount Kit	1
3	Accessory Kit	1
4	DVI to VGA Adapter	1

Ordering Information

Model No.	Product Description
RCO-1000-J1900	Compact fanless embedded system with Intel® J1900 CPU, 1x DVI-I, 2x COM
RCO-1010-J1900	Compact fanless embedded system with Intel® J1900 CPU, 1x DVI-I, 2x COM, 1x 2.5" SATA HDD Bay
RCO-1010A-J1900	Compact fanless embedded system with Intel® J1900 CPU, 1x DVI-I, 1x DP, DIO, 2x COM
RCO-1010B-J1900	Compact fanless embedded system with Intel® J1900 CPU, 1x DVI-I, 4x COM
RCO-1020C-J1900	Compact fanless embedded system with Intel® J1900 CPU, 1x DVI-I, 1x DP, DIO, 4x COM
RCO-1020D-J1900	Compact fanless embedded system with Intel® J1900 CPU, 1x DVI-I, 6x COM
RCO-1030-J1900	Compact fanless embedded system with Intel® J1900 CPU, 1x DVI-I, 1x DP, DIO, 6x COM

Optional Accessories

Model No.	Product Description
1-E09A06007	Adapter AC/DC 12V 5A 60W with 3pin Terminal Block Plug 5.0mm Pitch
1-TPCD00005	Power Cord, 3-pin US Type, 180cm
1-TPCD00002	Power Cord, European Type, 180cm
1-TPCD00001	Power Cord, 3-pin UK Type, 180cm
3-SIDE-0001	RCO-1000 Series Side Mount Kit
3-SIDE-0002	RCO-1010 Series Side Mount Kit
3-SIDE-0003	RCO-1020 Series Side Mount Kit
3-SIDE-0004	RCO-1030 Series Side Mount Kit
3-VESA-0003	RCO-1000 Series VESA Mount Kit
3-DINR-0004	DIN-Rail Mount Kit

Chapter 1

Product Introductions

1.1 Overview

Based on Intel® Celeron® J1900 (2.0GHz) Quad Core processor, RCO-1000 series is a high variety and diversity fanless embedded system. It offers modularize expansion I/O, rich connectivity interfaces, wide range (9~48V) DC power input, and high reliability even operating in temperature extremes (-40 °C ~ 70 °C).

Featuring with completely cable-less designed, high functional, one-piece housing design, and anti-vibration, RCO-1000 series are ruggedized systems that can operate in harsh environments and easy to install and maintain. A build in over voltage protection (OVP), over current protection (OCP), reserve voltage protection, and wide range DC power input makes RCO-1000 series are safety system for all industrial applications.

RCO-1000



**RCO-1010
RCO-1010A
RCO-1010B**



**RCO-1020C
RCO-1020D**



RCO-1030



1.1.1 Key Features

- Intel® Celeron® J1900 (2.0GHz) processor
- 1x DDR3L SO-DIMM max. up to 8GB
- Dual Independent Display from 1x DVI-I and 1x DisplayPort
- 2x Intel® GbE port, support Wake-on-LAN and PXE
- 1x USB 3.0, 3x USB2.0
- 6x RS232/422/485 port
- 4x Isolated DI, 4x Isolated DO
- 1x 2.5" SATA SSD/HDD bay, 1x mSATA and 2x SIM card socket
- 9~48VDC wide range power input, support AT/ATX mode
- 2x Mini-PCIe slot for Wi-Fi, GSM, or I/O expansion
- 1x Remote power on/off switch
- Universal I/O bracket for Mini-PCIe expansion

1.2 Hardware Specification

Processor System

- Onboard Intel® J1900 Quad Core Processor 2.0 GHz with AMI 64Mbit SPI BIOS.

Memory

- 1x 204-Pin DDR3L-1066/ 1333MHz SO-DIMM (unbuffered and non-ECC), max. up to 8GB

Display

Dual Display

- 1x DVI-D and 1x VGA (w/ Optional Split Cable)
- 1x DVI-D and 1x DisplayPort (RCO-1010A / RCO-1020C / RCO-1030 only)
- 1x DisplayPort and 1x VGA (w/ DVI to VGA Adapter) (RCO-1010A / RCO-1020C / RCO-1030 only)

Expansion

- 2x Full-size Mini PCIe Socket for Wi-Fi / GSM / Expansion Module
- 1x Universal I/O Bracket (RCO-1010 / RCO-1020C / RCO-1020D only)
- 2x Universal I/O Bracket (RCO-1030 only)

Ethernet

- 2 x Intel® I210-AT GbE LAN Port, Support Wake-on-LAN and PXE

Audio

- Realtek ALC888S Audio Codec
- 1x Mic-in and 1x Line-out

Watchdog Timer

- Software Programmable Supports 1~255 sec. System Reset

Storage

- 1x 2.5" SATA SSD/HDD Bay (RCO-1010 / RCO-1010A / RCO-1010B / RCO-1020C / RCO-1020D / RCO-1030 only)
- 1x mSATA (share by 1x Mini-PCIe Socket)
- 2x External SIM Card Socket

I/O Ports

- 1x USB 3.0 Port
- 3x USB 2.0 Port
- 2 x DB9 for COM1~2, Support RS232/422/485 with Auto Flow Control (RCO-1000 / RCO-1010 / RCO-1010A only)
- 4 x DB9 for COM1~4, Support RS232/422/485 with Auto Flow Control (RCO-1010B / RCO-1020C only)
- 6 x DB9 for COM1~6, Support RS232/422/485 with Auto Flow Control (RCO-1020D / RCO-1030 only)
- 3x Antenna Hole (RCO-1000 only)
- 4x Antenna Hole
- 1x Power Switch
- 1x Remote Power Switch
- 1x Reset Hole
- 1x AT/ATX Switch

Digital Input & Output

- 4x Digital Input (Source Type)
 - Input Voltage (Dry Contact):
 - Logic 0: Close to GND
 - Logic 1: Open
 - Input Voltage:
 - Logic 0: 3V max.
 - Logic 1: 5V min. (DI to COM-)
- 4x Digital Output
 - Supply Voltage: 5~30VDC
 - Sink Current: 200 mA Max. Per Channel

Power

- Support AT, ATX Mode
- 1x 3-pin Terminal Block Connector with Power Input 9~48VDC
- 1x Optional AC/DC 12V/5A, 60W Power Adapter

Environment

- Operating Temperature: Ambient with Air Flow: -40°C to 70°C (with Industrial Grade Peripherals)
- Storage Temperature: -40°C to 85°C
- Relative humidity: 10%~95% (non-condensing)

Physical

- Dimension (WxDxH, mm):
 - 150 x 105 x 37 mm (RCO-1000)
 - 150 x 105 x 49 mm (RCO-1010 / RCO-1010A / RCO-1010B)
 - 150 x 105 x 65 mm (RCO-1020C / RCO-1020D)
 - 150 x 105 x 83 mm (RCO-1030)
- Weight: 0.69 ~1.11 kg
- Construction: Extruded Aluminum with Heavy Duty Metal
- Mounting: Wall, Optional VESA / Side / DIN-Rail Mounting

Operating System

- Windows 10, Windows 8.1, WES8.1, Windows 7, WES7
- Linux kernel 3.X

Certifications

- CE
- FCC Class A

1.3 System I/O

1.3.1 RCO-1000

Front Panel

ATX power on/off switch

Press to power-on or power-off the system

AT/ATX mode select switch

Used to select AT or ATX power mode

Power LED

Indicates the power status of the system

HDD LED

Indicates the status of the hard drive

Watchdog LED

Indicates the watchdog status of the system

USB 3.0 port

Used to connect USB 3.0/2.0/1.1 device

USB 2.0 port

Used to connect USB 2.0/1.1 device

SIM card

Used to insert a SIM card

LAN port

Used to connect the system to a local area network

Line-out

Used to connect a speaker

Mic-in

Used to connect a microphone

Remote power on/off switch

Used to plug a power on/off switch with terminal block

Reset Hole

Used to reset the system

Antenna hole

Used to connect an antenna for optional Mini-PCIe WiFi module

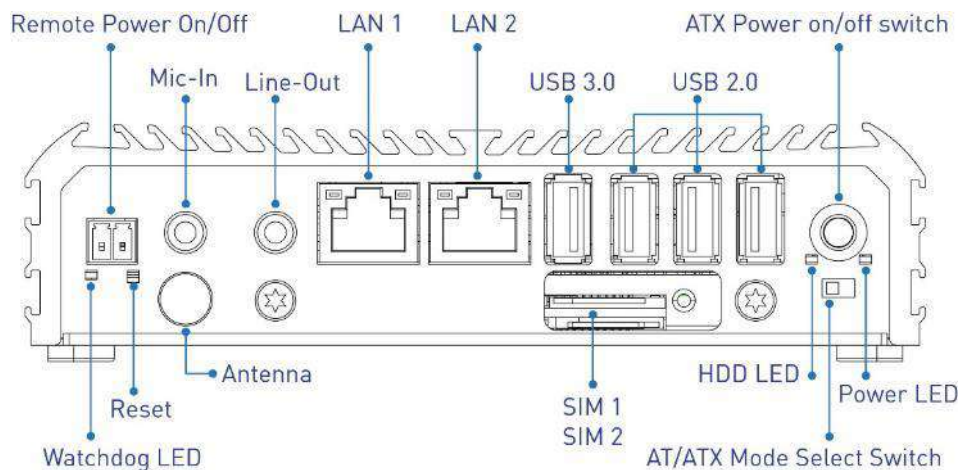

Rear Panel

DC IN

Used to plug a DC power input with terminal block

DVI-I port

Used to connect a DVI monitor or connect optional split cable for dual display mode

COM port

COM1 ~ COM2 support RS232/422/485 serial device

Antenna hole

Used to connect an antenna for optional Mini-PCIe WiFi module

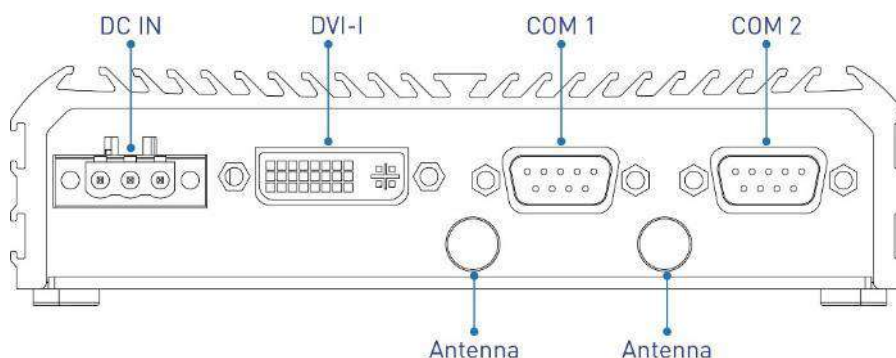

1.3.2 RCO-1010 / RCO-1010A / RCO-1010B

Front Panel

ATX power on/off switch

Press to power-on or power-off the system

AT/ATX mode select switch

Used to select AT or ATX power mode

Power LED

Indicates the power status of the system

HDD LED

Indicates the status of the hard drive

Watchdog LED

Indicates the watchdog status of the system

USB 3.0 port

Used to connect USB 3.0/2.0/1.1 device

USB 2.0 port

Used to connect USB 2.0/1.1 device

SIM card

Used to insert a SIM card

LAN port

Used to connect the system to a local area network

Line-out

Used to connect a speaker

Mic-in

Used to connect a microphone

Remote power on/off switch

Used to plug a power on/off switch with terminal block

Reset Hole

Used to reset the system

Antenna hole

Used to connect an antenna for optional Mini-PCIe WiFi module

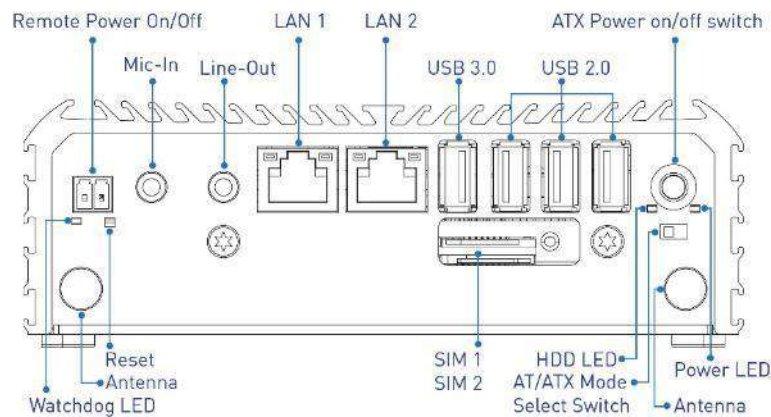

Rear Panel

DC IN

Used to plug a DC power input with terminal block

DVI-I port

Used to connect a DVI monitor or connect optional split cable for dual display mode

DisplayPort port (RCO-1010A only)

Used to connect a DisplayPort monitor

Digital I/O Terminal Block

The Digital I/O terminal block supports 4 digital input and 4 digital output (RCO-1010A only)

COM port

COM1 ~ COM2 support RS232/422/485 serial device (RCO-1010, RCO-1010A Only)

COM1 ~ COM4 support RS232/422/485 serial device (RCO-1010B Only)

Antenna hole

Used to connect an antenna for optional Mini-PCIe WiFi module

Expandable I/O bracket

Used to customized I/O output (RCO-1010 only)

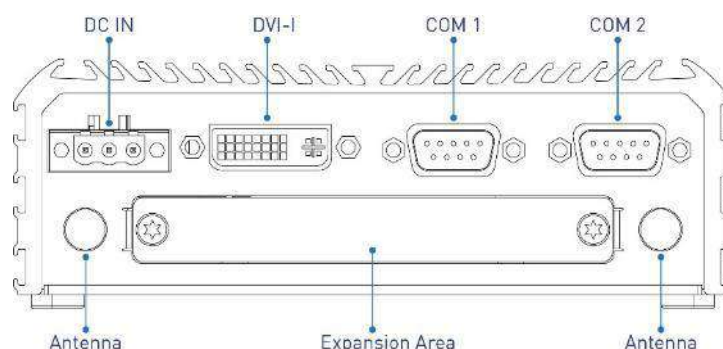

1.3.3 RCO-1020C / RCO-1020D

Front Panel

ATX power on/off switch

Press to power-on or power-off the system

AT/ATX mode select switch

Used to select AT or ATX power mode

Power LED

Indicates the power status of the system

HDD LED

Indicates the status of the hard drive

Watchdog LED

Indicates the watchdog status of the system

USB 3.0 port

Used to connect USB 3.0/2.0/1.1 device

USB 2.0 port

Used to connect USB 2.0/1.1 device

SIM card

Used to insert a SIM card

LAN port

Used to connect the system to a local area network

Line-out

Used to connect a speaker

Mic-in

Used to connect a microphone

Remote power on/off switch

Used to plug a power on/off switch with terminal block

Reset Hole

Used to reset the system

Antenna hole

Used to connect an antenna for optional Mini-PCIe WiFi module

Expandable I/O bracket

Used to customized I/O output

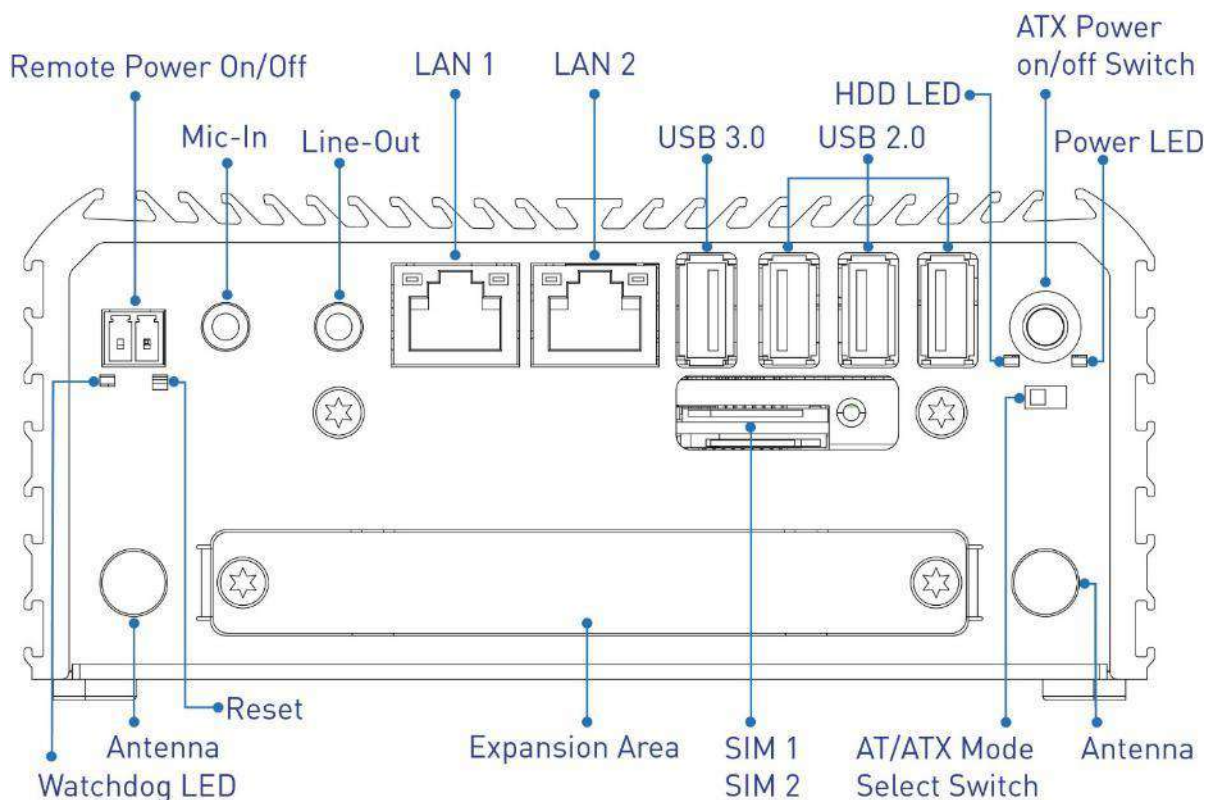

Rear Panel

DC IN

Used to plug a DC power input with terminal block

DVI-I port

Used to connect a DVI monitor or connect optional split cable for dual display mode

DisplayPort port (RCO-1020C only)

Used to connect a DisplayPort monitor

Digital I/O Terminal Block

The Digital I/O terminal block supports 4 digital input and 4 digital output (RCO-1020C only)

COM port

COM1 ~ COM4 support RS232/422/485 serial device (RCO-1020C Only)

COM1 ~ COM6 support RS232/422/485 serial device (RCO-1020D Only)

Antenna hole

Used to connect an antenna for optional Mini-PCIe WiFi module

Expandable I/O bracket

Used to customized I/O output

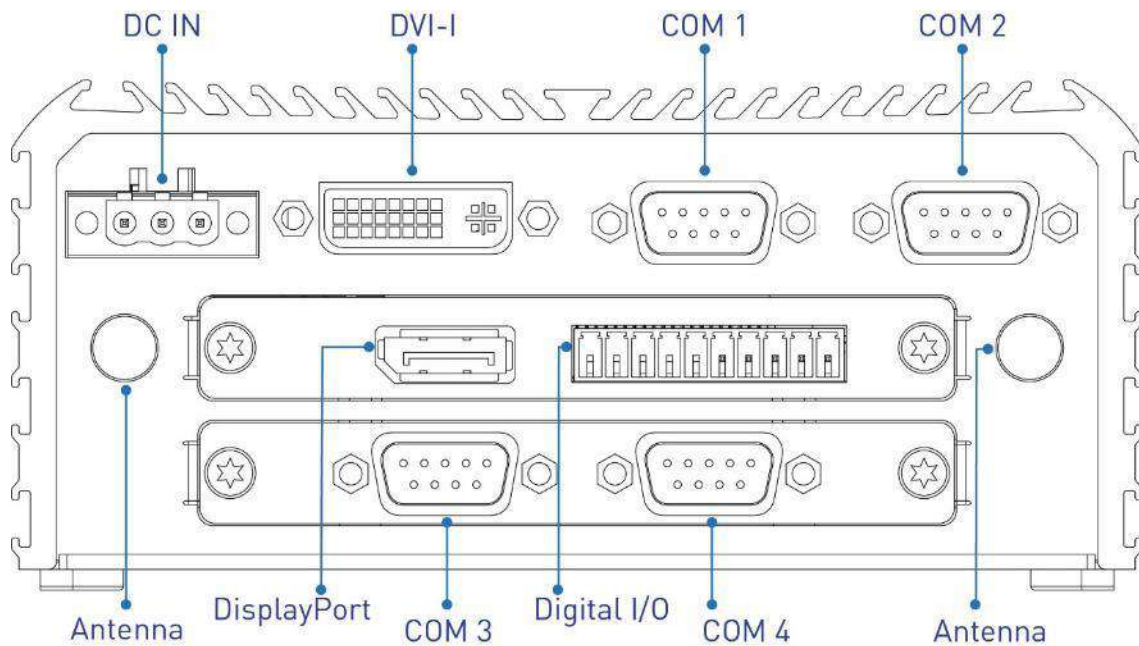

1.3.4 RCO-1030

Front Panel

ATX power on/off switch

Press to power-on or power-off the system

AT/ATX mode select switch

Used to select AT or ATX power mode

Power LED

Indicates the power status of the system

HDD LED

Indicates the status of the hard drive

Watchdog LED

Indicates the watchdog status of the system

USB 3.0 port

Used to connect USB 3.0/2.0/1.1 device

USB 2.0 port

Used to connect USB 2.0/1.1 device

SIM card

Used to insert a SIM card

LAN port

Used to connect the system to a local area network

Line-out

Used to connect a speaker

Mic-in

Used to connect a microphone

Remote power on/off switch

Used to plug a power on/off switch with terminal block

Reset Hole

Used to reset the system

Antenna hole

Used to connect an antenna for optional Mini-PCIe WiFi module

Expandable I/O bracket

Used to customized I/O output

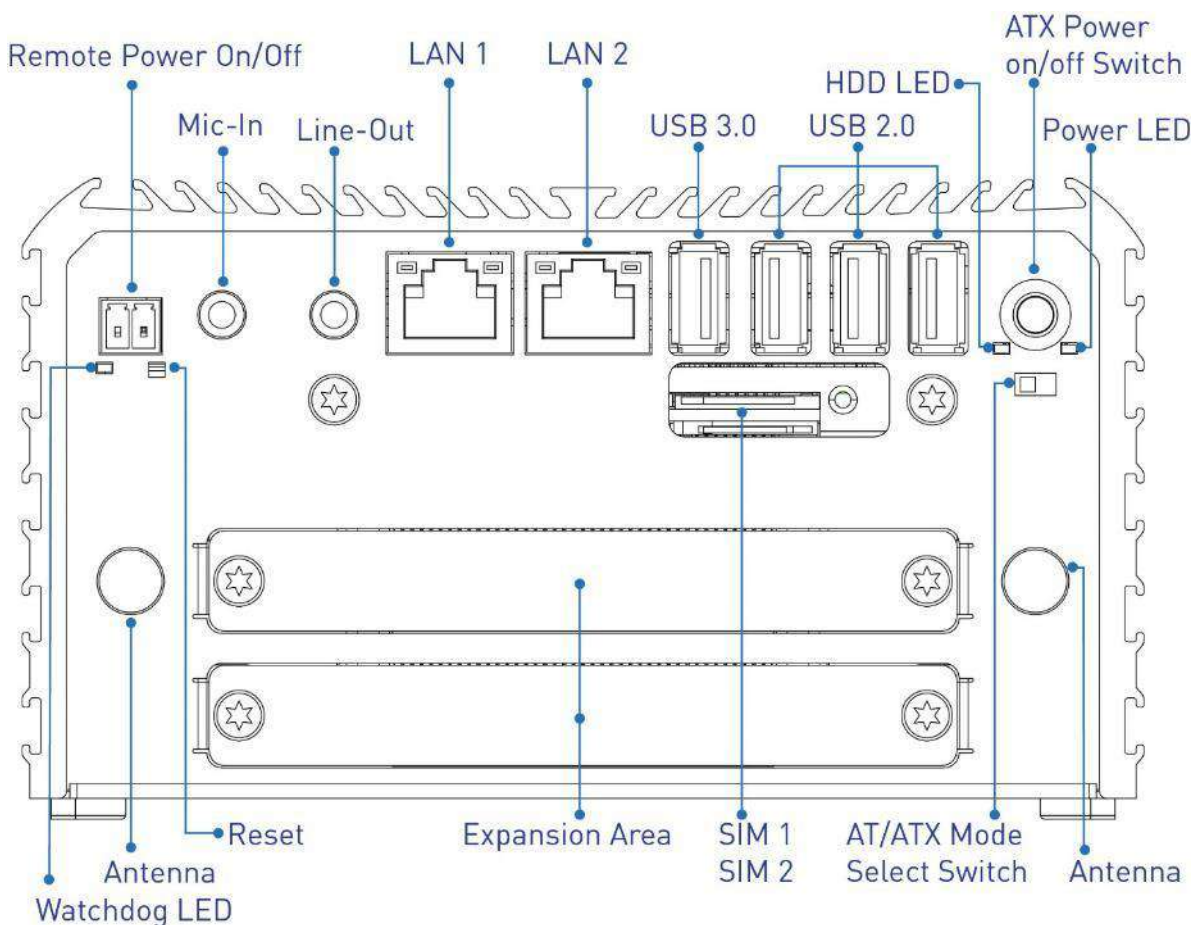

Rear Panel

DC IN

Used to plug a DC power input with terminal block

DVI-I port

Used to connect a DVI monitor or connect optional split cable for dual display mode

DisplayPort port

Used to connect a DisplayPort monitor

Digital I/O Terminal Block

The Digital I/O terminal block supports 4 digital input and 4 digital output

COM port

COM1 ~ COM6 support RS232/422/485 serial device

Antenna hole

Used to connect an antenna for optional Mini-PCIe WiFi module

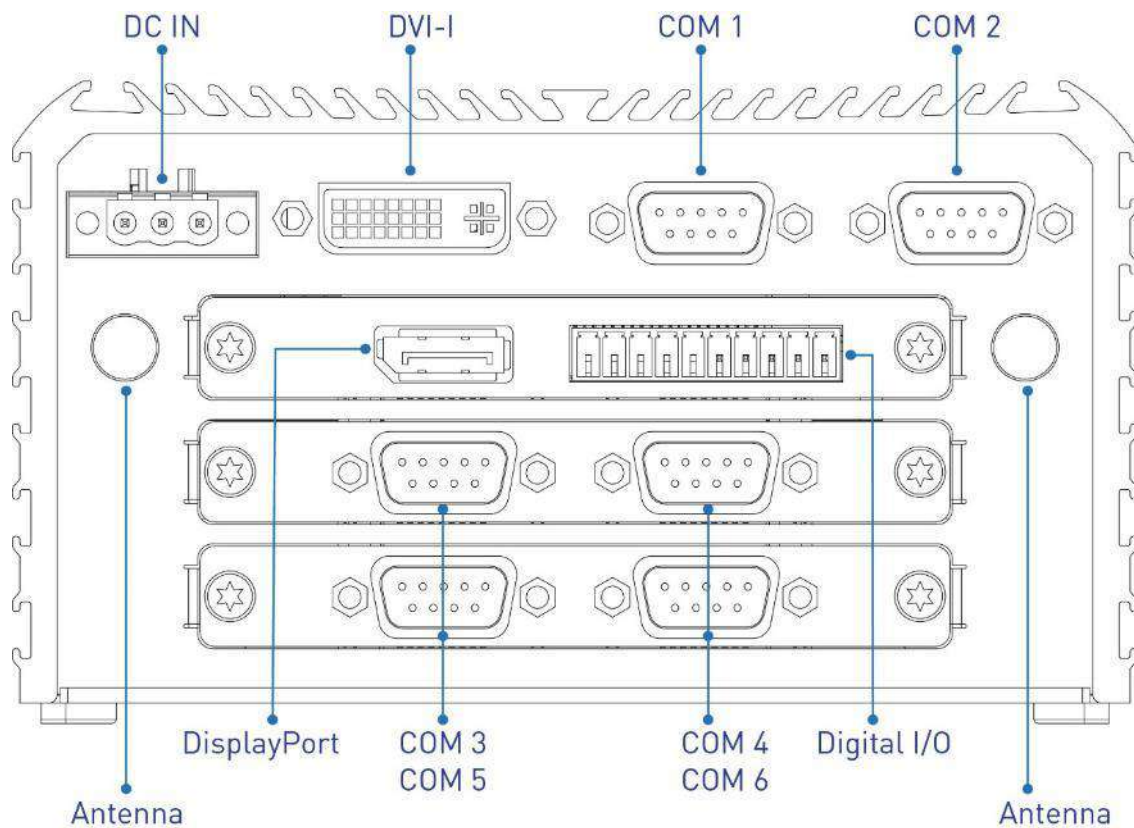

1.4 Mechanical Dimensions

1.4.1 RCO-1000

Unit: mm

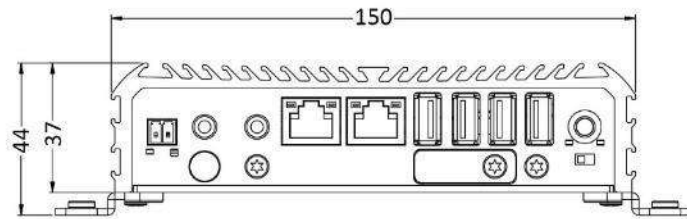
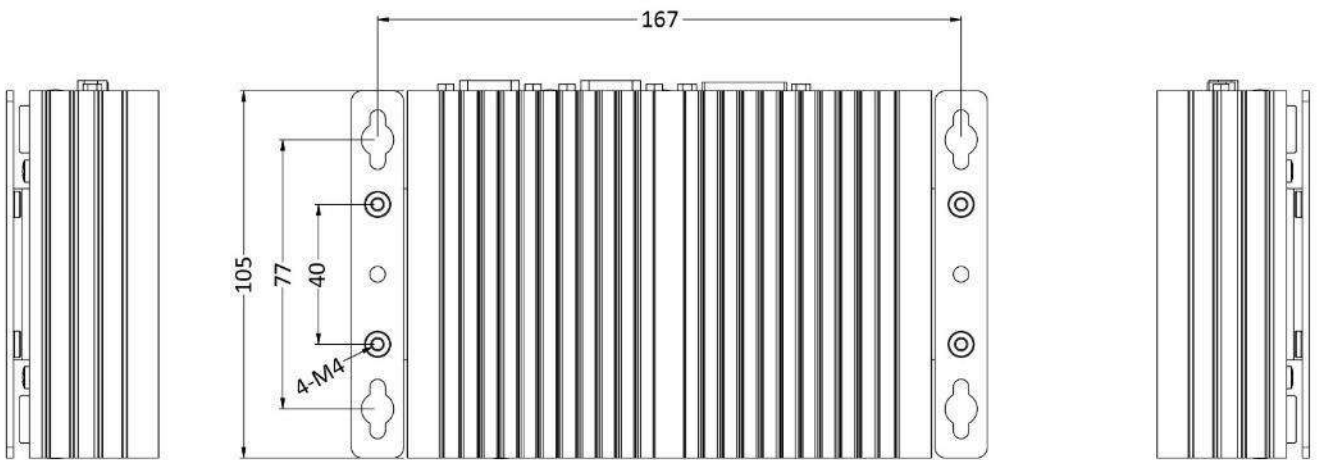
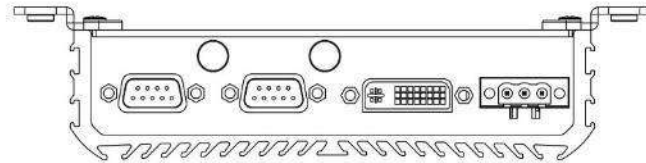

1.4.2 RCO-1010 / RCO-1010A / RCO-1010B

Unit: mm

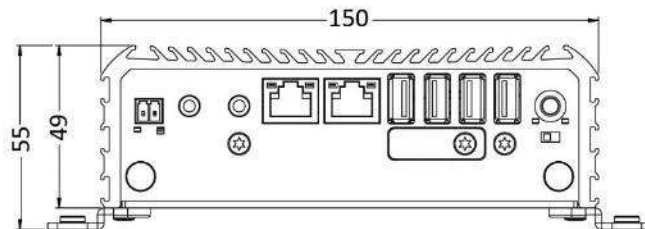
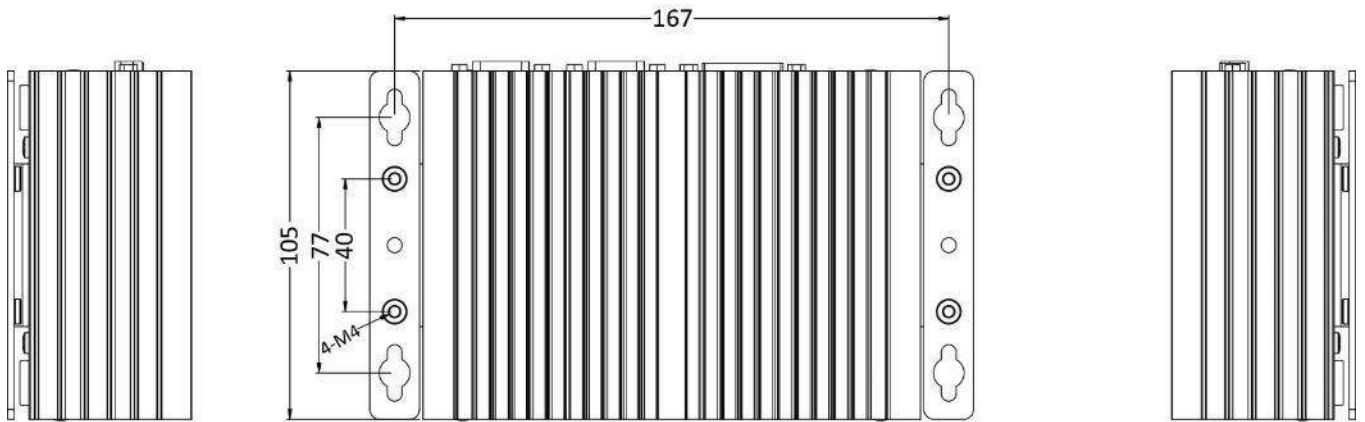
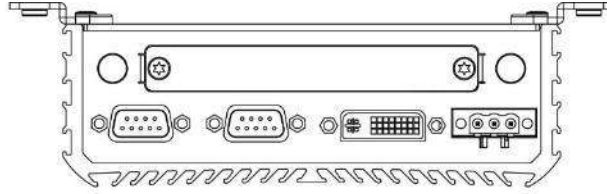

1.4.3 RCO-1020C / RCO-1020D

Unit: mm

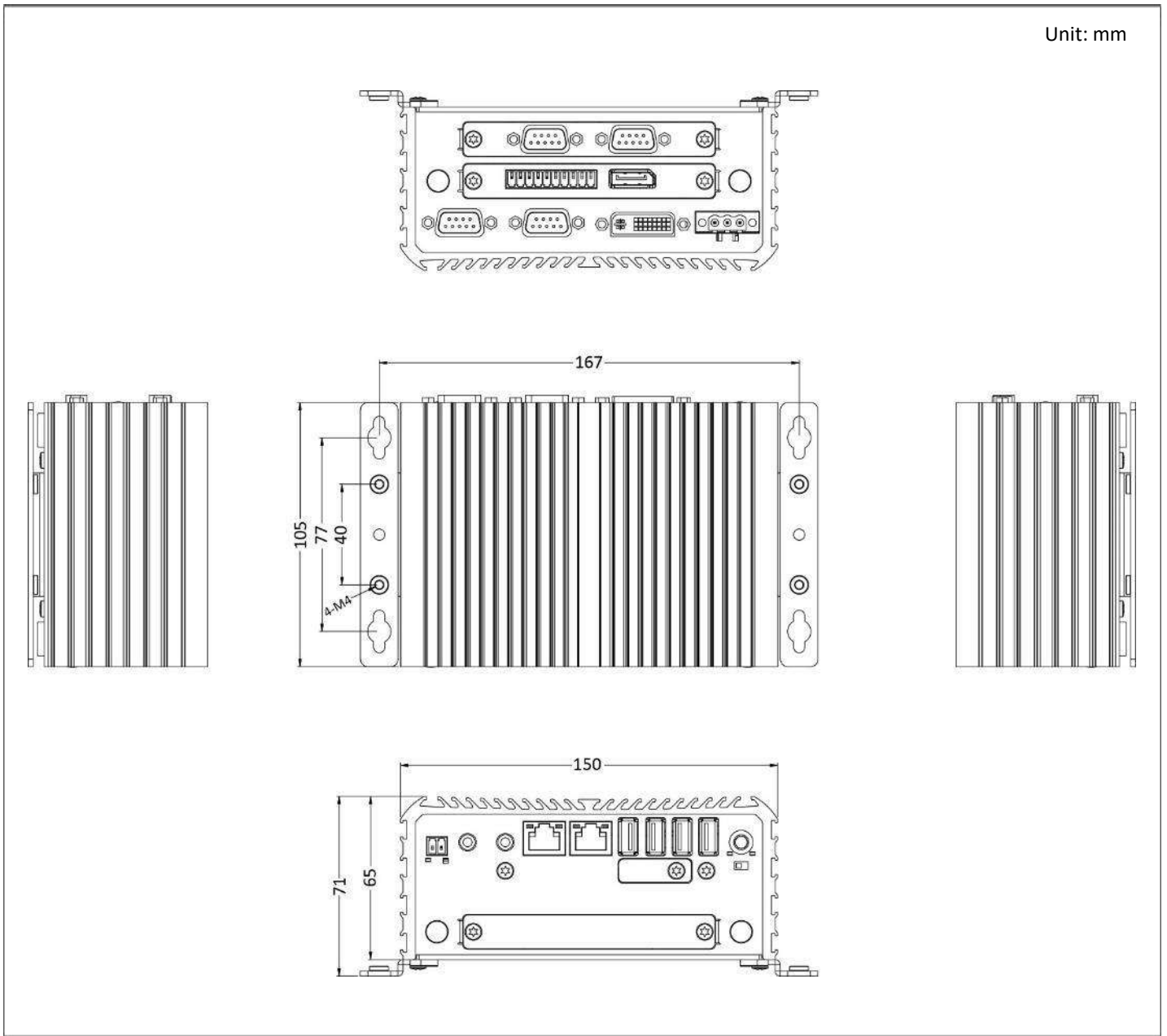

1.4.4 RCO-1030

Unit: mm

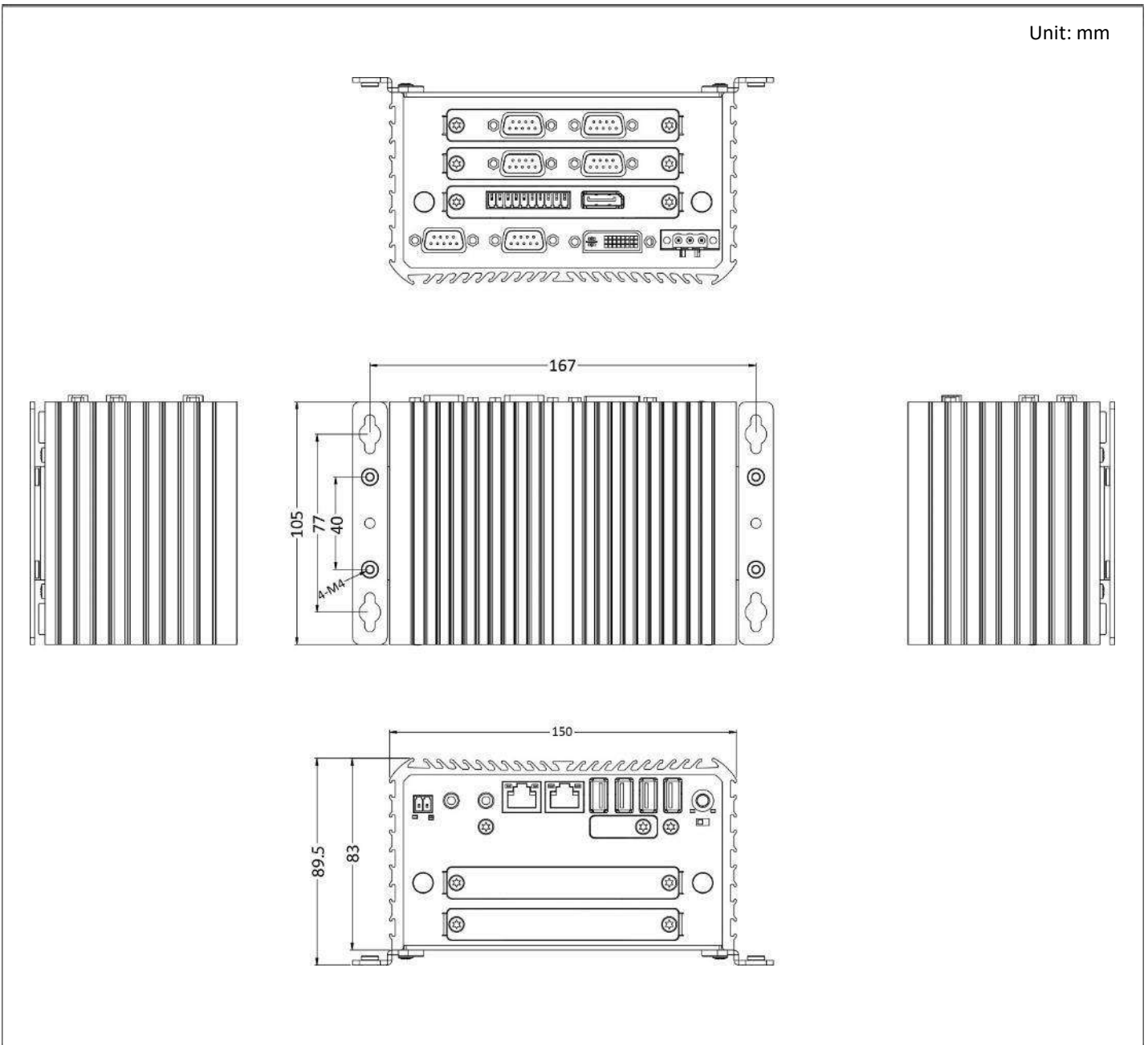

Chapter 2

Switches and Connectors

2.1 Switch and Connector Locations

2.1.1 Top View

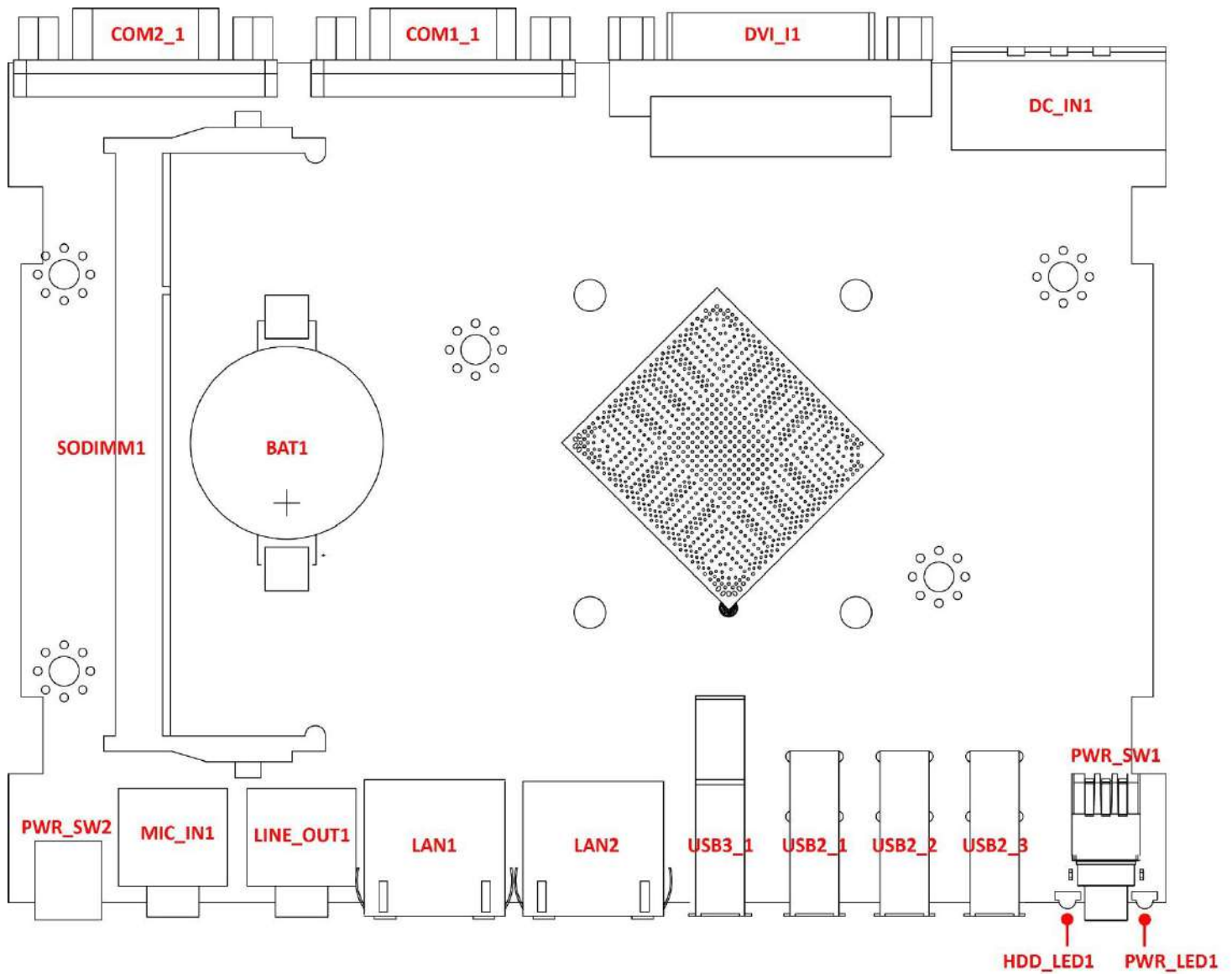

2.1.2 Bottom View

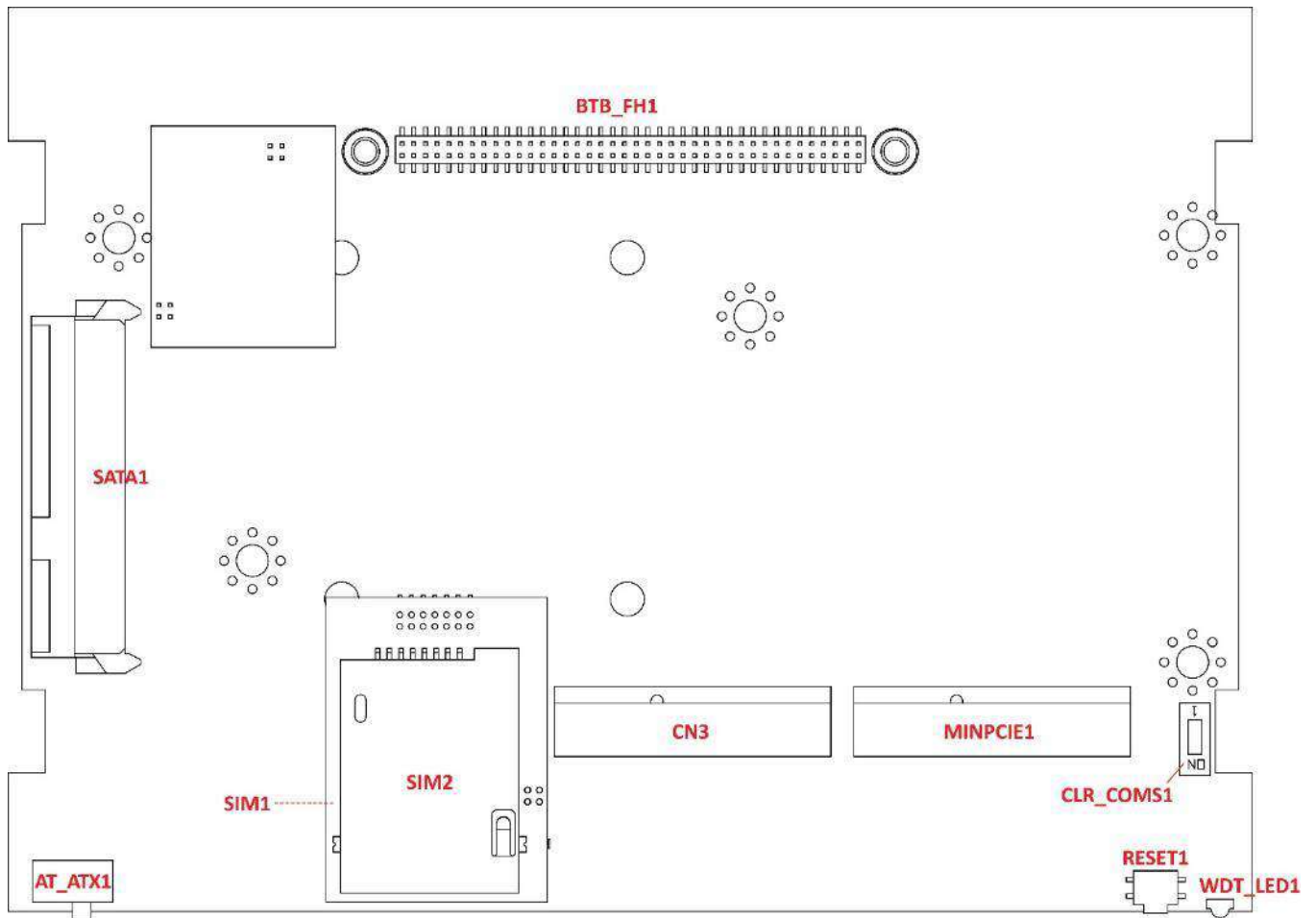

2.1.3 Daughter board view

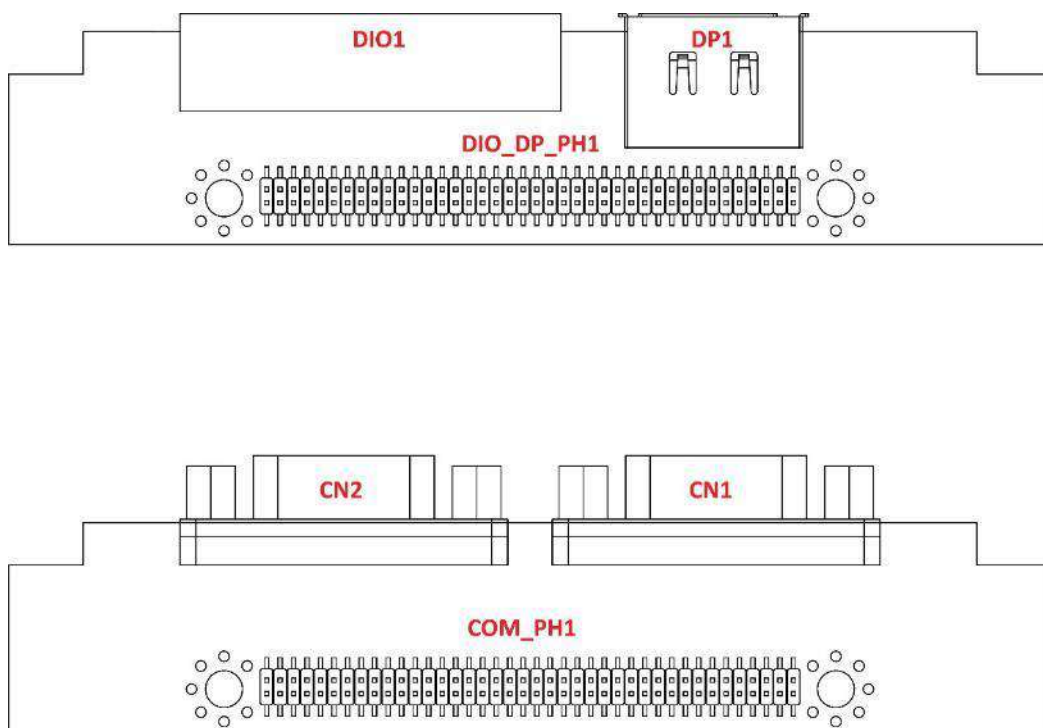

2.2 Connector / Switch Definition

List of Connector / Switch

Connector Location	Definition
AT_ATX1	AT / ATX Power Mode Switch
CLR_CMOS1	Clear BIOS Switch
PWR_SW1	Power Switch
PWR_LED1	Power LED Status
HDD_LED1	HDD Access LED Status
WDT_LED1	Watchdog LED Status
USB2_1, USB2_2, USB2_3	USB 2.0 Port
USB3_1	USB 3.0 Port
LAN1, LAN2	LAN Port
SIM1, SIM2	SIM Card Socket
LINE_OUT1	Line-out Jack
MIC_IN1	Mic-in Jack
PWR_SW2	Remote Power Switch
RESET1	Reset Switch
DC_IN1	3-pin DC 9~48V Power Input Connector
DVI_I1	DVI-I Connector
COM1_1, COM2_1, CN1, CN2	RS232 / RS422 / RS485 Connector
DP1	DisplayPort Connector
DIO1	4DI / 4DO Connector
MINIPCIE1	Mini PCI-Express Socket
CN3	Mini PCI-Express / mSATA Socket
SATA1	SATA with Power Connector

2.3 Switches Definitions

AT_ATX1: AT / ATX Power Mode Switch

Switch	Definition
1-2 (Right)	ATX Power Mode (Default)
2-3 (Left)	AT Power Mode

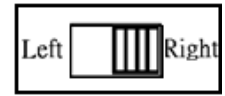

CLR_CMOS1: Clear BIOS Switch

Switch	Definition
Off	Normal Status (Default)
ON	Clear BIOS



2.4 Connectors Definitions

PWR_SW1: Power Button

Pin	Definition	Pin	Definition
1	NC	4	GND
2	Power Button	5	NC
3	NC	6	GND

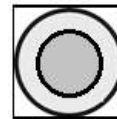

PWR_LED1: Power LED Status

Pin	Definition
1	POWER LED+
2	POWER LED-



HDD_LED1: HDD Access LED Status

Pin	Definition
1	HDD LED+
2	HDD LED-



WDT_LED1: Watchdog LED Status

Pin	Definition
1	HDD LED+
2	HDD LED-



USB2_1, USB2_2, USB2_3: USB2.0 Connector, Type A

Pin	USB2_1 Definition	USB2_2 Definition	USB2_3 Definition
1	+5V	+5V	+5V
2	USB2_D2-	USB2_D3-	USB2_D4-
3	USB2_D2+	USB2_D3+	USB2_D4+
4	GND	GND	GND

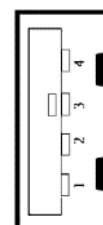

USB3_1: USB 3.0 Connector, Type A

Pin	Definition	Pin	Definition
1	+5V	6	USB3_RX+
2	USB2_DATA1-	7	GND
3	USB2_DATA1+	8	USB3_TX-
4	GND	9	USB3_TX+
5	USB3_RX-		

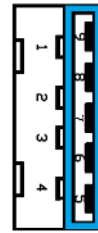

LAN1, LAN2: RJ45 with LEDs Port

Pin	Definition	Pin	Definition
1	LAN1_MDI0P	5	LAN1_MDI2N
2	LAN1_MDI0N	6	LAN1_MDI1N
3	LAN1_MDI1P	7	LAN1_MDI3P
4	LAN1_MDI2P	8	LAN1_MDI3N

Pin	Definition	Pin	Definition
1	LAN2_MDI0P	5	LAN2_MDI2N
2	LAN2_MDI0N	6	LAN2_MDI1N
3	LAN2_MDI1P	7	LAN2_MDI3P
4	LAN2_MDI2P	8	LAN2_MDI3N

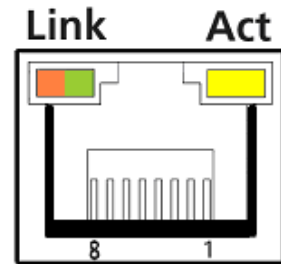

Link LED Status	Definition	Act LED Status	Definition
Steady Orange	1Gbps Network Link	Blinking Yellow	Data Activity
Steady Green	100Mbps Network Link	Off	No Activity
Off	10Mbps Network Link		

SIM1, SIM2 : SIM Card Socket

Pin	Definition	Pin	Definition
C1	UIM_PWR	C6	UIM_VPP
C2	UIM_RESET	C7	UIM_DATA
C3	UIM_CLK	CD	NC
C5	GND	COM	GND

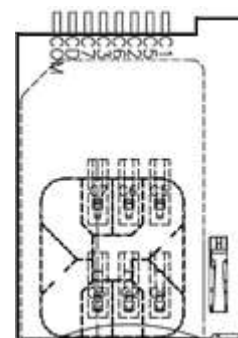

LINE_OUT1 : Line-out Jack (Green)

Connector Type: 5-pin Phone Jack

Pin	Definition
1	GND
2	OUT_R
3	NC
4	GND
5	OUT_L



MIC_IN1: Microphone Jack (Pink)

Connector Type: 5-pin Phone Jack

Pin	Definition
1	GND
2	MIC_R
3	NC
4	GND
5	MIC_L



PWR_SW2 : Remote Power Switch

Connector Type: Terminal Block 1X2 2-pin, 3.5mm pitch

Pin	Definition
1	Power Button
2	GND



RESET1 : Reset Button

Pin	Definition
1	RESET
2	GND



DC_IN1: DC Power Input Connector (+9~48V)

Connector Type: Terminal Block 1X3 3-pin, 5.0mm pitch

Pin	Definition
1	+9~48VIN
3	GND

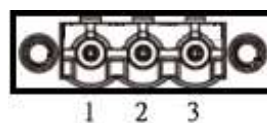

DVI_I1: DVI-I Connector

Pin	Definition	Pin	Definition
1	DVI_TX2-	16	DVI Hot Plug Detect
2	DVI_TX2+	17	DVI_TX0-
3	GND	18	DVI_TX0+
4	NC	19	GND
5	NC	20	NC
6	DDC_CLOCK	21	NC
7	DDC_DATA	22	GND
8	VGA_VSYNC	23	DVI_TXCLK+
9	DVI_TX1-	24	DVI_TXCLK-
10	DVI_TX1+	C1	VGA_RED
11	GND	C2	VGA_GREEN
12	NC	C3	VGA_BLUE
13	NC	C4	VGA_HSYNC
14	+5V	C5	GND
15	GND		

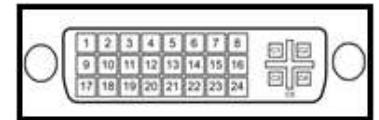
**COM1_1: RS232 / RS422 / RS485 Connector**

Connector Type: 9-pin D-Sub

Pin	RS232 Definition	RS422 / 485 Full Duplex Definition	RS485 Half Duplex Definition
1	DCD1	TX1-	DATA1-
2	RxD1	TX1+	DATA1+
3	TxD1	RX1+	
4	DTR1	RX1-	
5	GND		
6	DSR1		
7	RTS1		
8	CTS1		
9	RI1		

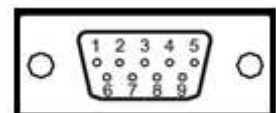

COM2_1: RS232 / RS422 / RS485 Connector

Connector Type: 9-pin D-Sub

Pin	RS232 Definition	RS422 / 485 Full Duplex Definition	RS485 Half Duplex Definition
1	DCD2	TX2-	DATA2-
2	RxD2	TX2+	DATA2+
3	TxD2	RX2+	
4	DTR2	RX2-	
5	GND		
6	DSR2		
7	RTS2		
8	CTS2		
9	RI2		

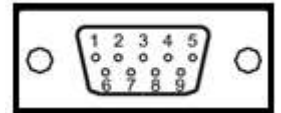

CN1: RS232 / RS422 / RS485 Connector

Connector Type: 9-pin D-Sub

Pin	RS232 Definition	RS422 / 485 Full Duplex Definition	RS485 Half Duplex Definition
1	DCD3 (DCD5)	TX3- (TX5-)	DATA3- (DATA5-)
2	RxD3 (RxD5)	TX3+ (TX5+)	DATA3+ (DATA5+)
3	TxD3 (TxD5)	RX3+ (RX5+)	
4	DTR3 (DTR5)	RX3- (RX5-)	
5	GND		
6	DSR3 (DSR5)		
7	RTS3 (RTS5)		
8	CTS3 (CTS5)		
9	RI3 (RI5)		

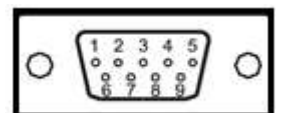

CN2: RS232 / RS422 / RS485 Connector

Connector Type: 9-pin D-Sub

Pin	RS232 Definition	RS422 / 485 Full Duplex Definition	RS485 Half Duplex Definition
1	DCD4 (DCD6)	TX4- (TX6-)	DATA4- (DATA6-)
2	RxD4 (RxD6)	TX4+ (TX6+)	DATA4+ (DATA6+)
3	TxD4 (TxD6)	RX4+ (RX6+)	
4	DTR4 (DTR6)	RX4- (RX6-)	
5	GND		
6	DSR4 (DSR6)		
7	RTS4 (RTS6)		
8	CTS4 (CTS6)		
9	RI4 (RI6)		

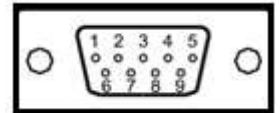

DP1: DisplayPort Connector

Pin	Definition	Pin	Definition
1	DP_LANE0_P	11	GND
2	GND	12	DP_LANE3_N
3	DP_LANE0_N	13	GND
4	DP_LANE1_P	14	GND
5	GND	15	DP_AUX_P
6	DP_LANE1_N	16	GND
7	DP_LANE2_P	17	DP_AUX_N
8	GND	18	DP_HPD
9	DP_LANE2_N	19	GND
10	DP_LANE3_P	20	DP_PWR

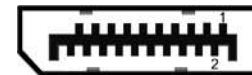

DIO1: Digital Input / Output Connector

Connector Type: Terminal Block 1X10 10-pin, 3.5mm pitch

Pin	Definition	Pin	Definition
1	DC INPUT	6	DO1
2	DI1	7	DO2
3	DI2	8	DO3
4	DI3	9	DO4
5	DI4	10	GND

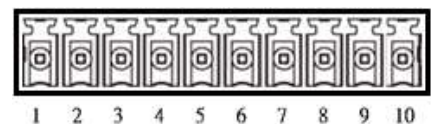

Reference Input Circuit

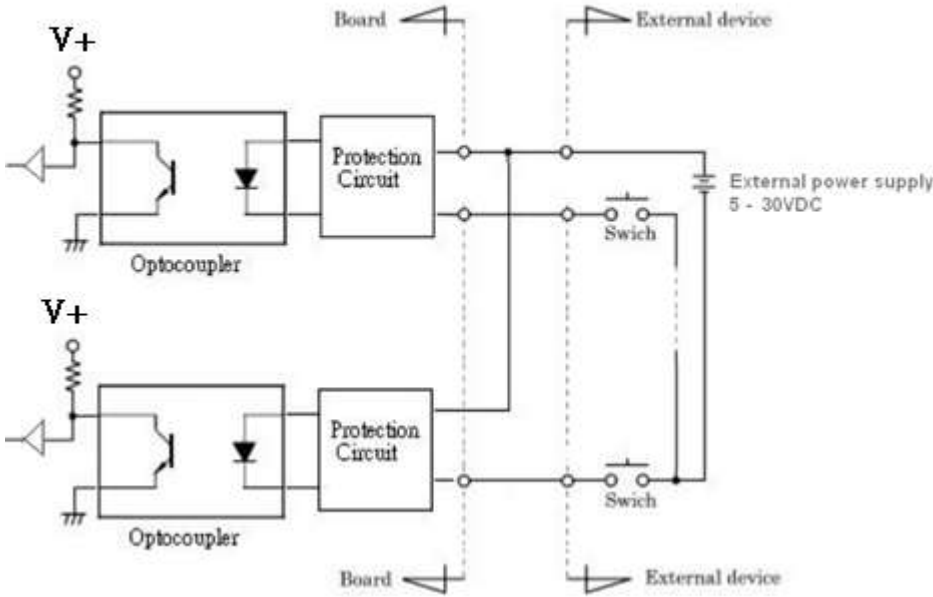

Digital Input Wiring

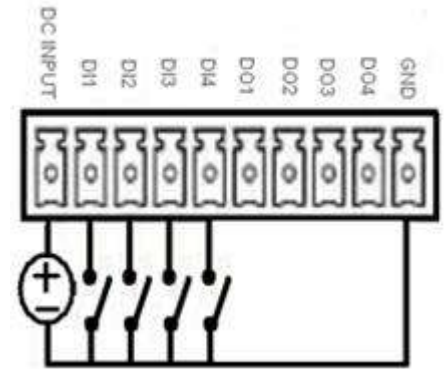

External Output Circuit

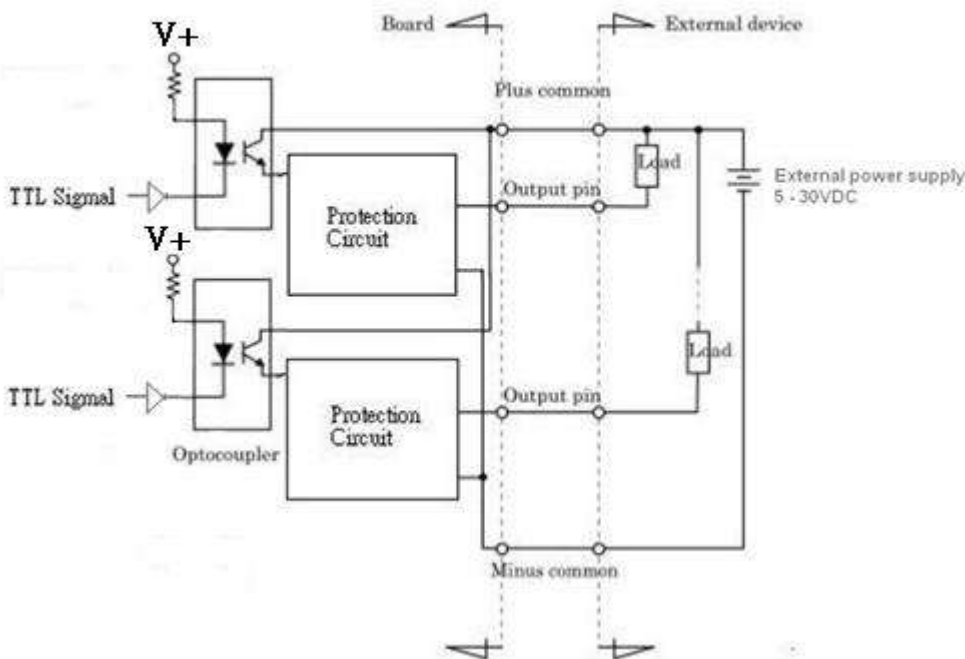

Digital Output Wiring

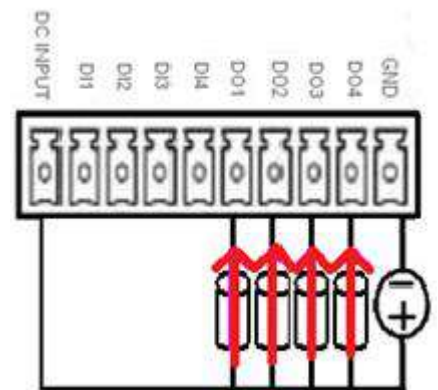

MINIPCI-E1: Mini PCI-Express Socket

Pin	Definition	Pin	Definition	Pin	Definition
1	WAKE#	19	NC	37	GND
2	+3.3V	20	+3.3V	38	USB_DP1
3	NC	21	GND	39	+3.3V
4	GND	22	MINIPCI-E RST#	40	GND
5	NC	23	MINIPCI-E_RXN1	41	+3.3V
6	+1.5V	24	+3.3V	42	NC
7	CLKREQ1#	25	MINIPCI-E_RXP1	43	GND
8	USIM_VCC	26	GND	44	NC
9	GND	27	GND	45	NC
10	USIM_DATA	28	+1.5V	46	NC
11	MINIPCI-E_CLKN1	29	GND	47	NC
12	USIM_CLK	30	SMB_CLK	48	+1.5V
13	MINIPCI-E_CLKP1	31	MINIPCI-E_TXN1	49	NC
14	USIM_RST	32	SMB_DATA	50	GND
15	GND	33	MINIPCI-E_TXP1	51	NC
16	USIM_VPP	34	GND	52	+3.3V
17	NC	35	GND		
18	GND	36	USB_DN1		

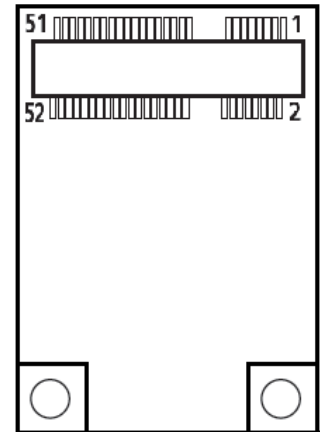
**CN3: Mini PCI-Express / mSATA Socket**

Pin	Definition	Pin	Definition	Pin	Definition
1	WAKE#	19	NC	37	GND
2	+3.3V	20	+3.3V	38	USB_DP2
3	NC	21	GND	39	+3.3V
4	GND	22	MINIPCI-E RST#	40	GND
5	NC	23	MINIPCI-E_RXN2 (SATA_RXP0)	41	+3.3V
6	+1.5V	24	+3.3V	42	NC
7	CLKREQ2#	25	MINIPCI-E_RXP2 (SATA_RXN0)	43	GND
8	USIM_VCC	26	GND	44	NC
9	GND	27	GND	45	NC
10	USIM_DATA	28	+1.5V	46	NC
11	MINIPCI-E_CLKN2	29	GND	47	NC
12	USIM_CLK	30	SMB_CLK	48	+1.5V
13	MINIPCI-E_CLKP2	31	MINIPCI-E_TXN2 (SATA_TXN0)	49	NC
14	USIM_RST	32	SMB_DATA	50	GND
15	GND	33	MINIPCI-E_TXP2 (SATA_TXP0)	51	NC
16	USIM_VPP	34	GND	52	+3.3V
17	NC	35	GND		
18	GND	36	USB_DN1		

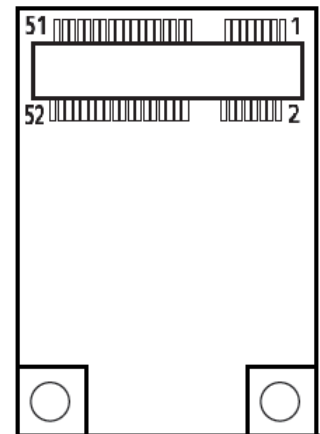

SATA1: SATA with Power Connector

Pin	Definition	Pin	Definition
1	GND	12	GND
2	SATA_TXP1	13	GND
3	SATA_TXN1	14	+5V
4	GND	15	+5V
5	SATA_RXN1	16	+5V
6	SATA_RXP1	17	GND
7	GND	18	GND
8	+3.3V	19	GND
9	+3.3V	20	+12V
10	+3.3V	21	+12V
11	GND	22	+12V

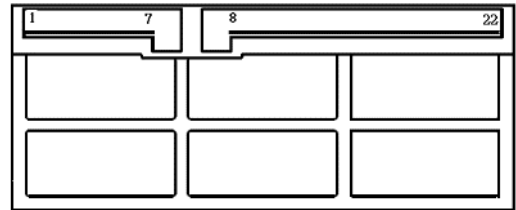

Chapter 3

System Setup

3.1 Set torque force to 3.5 kgf-cm to execute all the screwing and unscrewing.

3.2 Removing the chassis bottom cover

**WARNING**

In order to prevent electric shock or system damage, before removing the chassis cover, must turn off power and disconnect the unit from power source.

1. Turn the system upside down. Unscrew the 4 screws (M3x5L) on the bottom cover.



2. Now you can remove the bottom cover.



3.3 Removing HDD bracket

1. This step is does not apply to RCO-1000 model as it has no HDD bracket.
2. Unscrew four screws (M3x5L) circled below.



3. Now you can remove the HDD bracket.

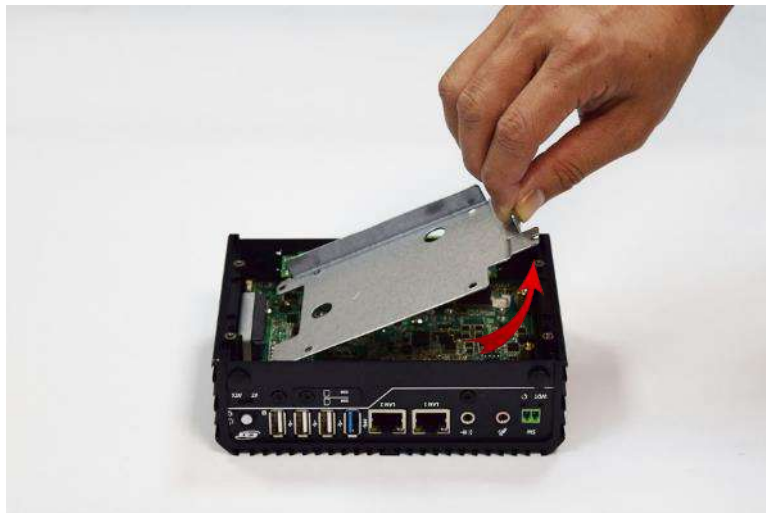

3.4 Removing chassis top cover

1. Unscrew the three screws (M3x5L) and two copper stud (M3x11L) highlighted below.

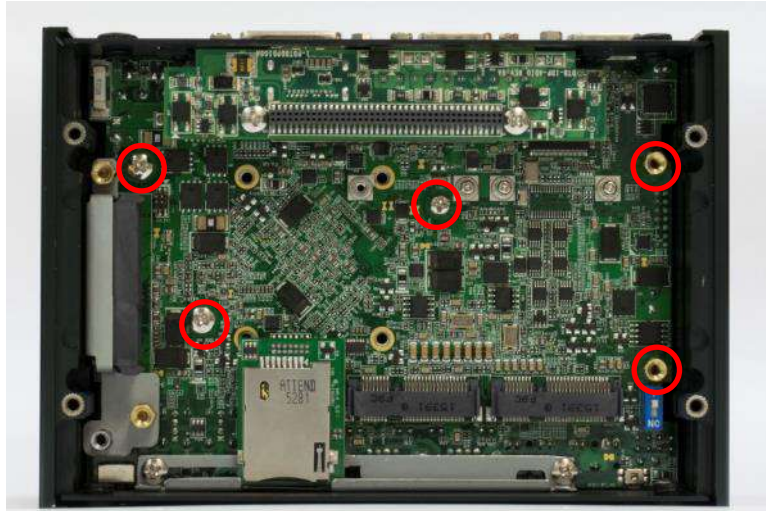

2. Hold the body of the system and lift it vertically away from the top cover.

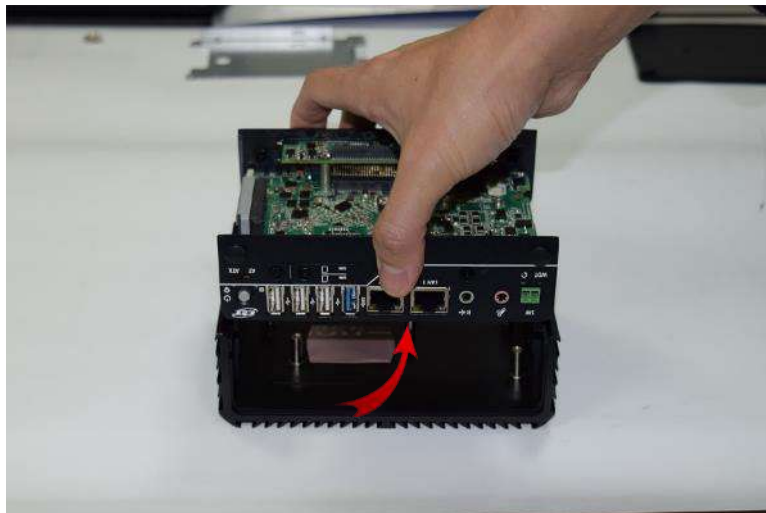

3. Top cover separated from the system body.

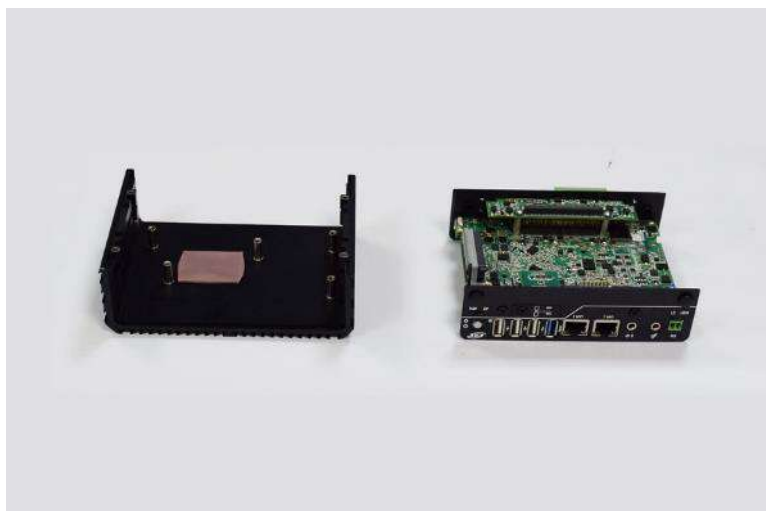

3.5 Installing SODIMM

1. Place the system body with SODIMM socket facing upward.



2. Insert memory module from 45 degree direction.



3. Press the memory module vertically downward until you hear the “click” sound. Make sure the memory module is firmly in place.



3.6 Installing Mini PCIe card / mSATA

1. Place the system body upside down so you can see the 2x mini card socket. Mini PCIe 2 (CN3) can support mSATA.

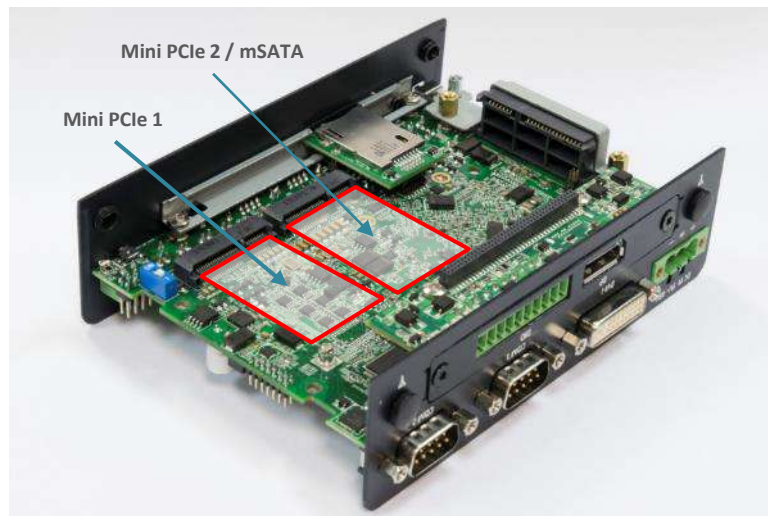

2. Insert mini PCIe card or mSATA module from 45 degree direction.



3. Press the mini PCIe card or mSATA module down and lock it with two screws (M2x3.7L).



3.7 Installing antenna

1. Remove antenna hole cover on the system panel.



2. Have antenna jack penetrate through the hole.



3. Put on washer and fasten the nut with antenna jack.



4. Assemble the antenna and antenna jack together.



5. Attach the RF connector at the cable-end onto the communication module.



3.8 Assemble chassis top cover

1. Place both top cover and system body upside down as shown below.

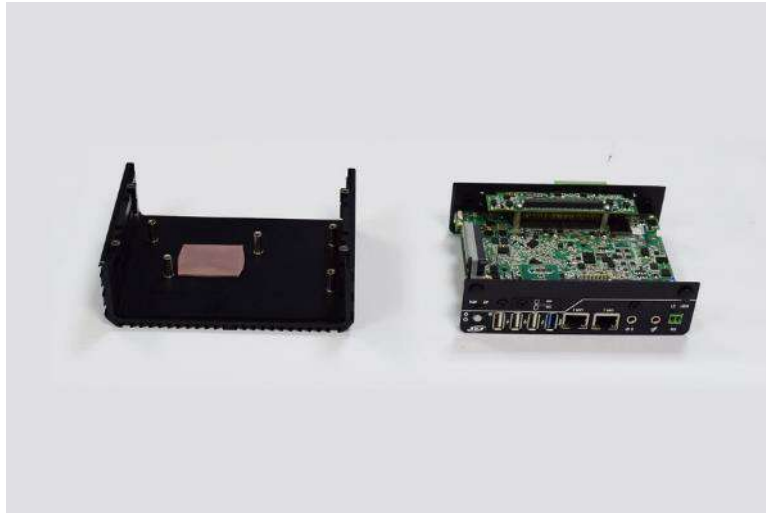

2. Ensure thermal pad is in place where the CPU is located or paste the thermal pad back on the CPU thermal block.

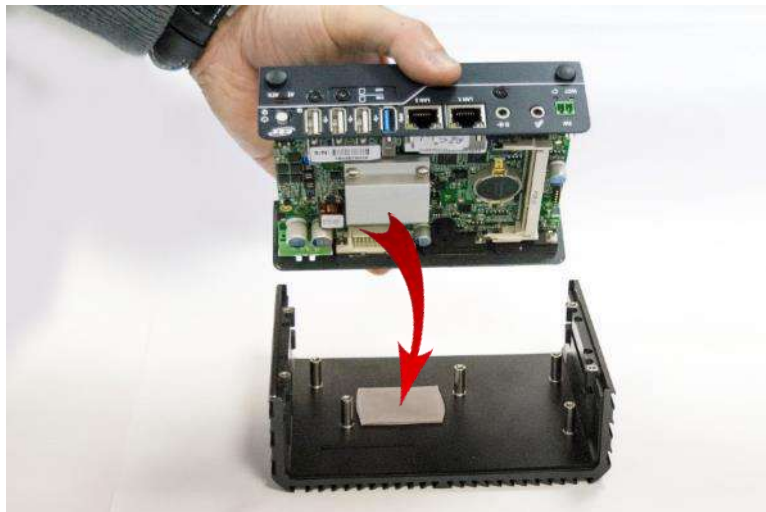

3. Put on washer and fasten the nut with antenna jack.

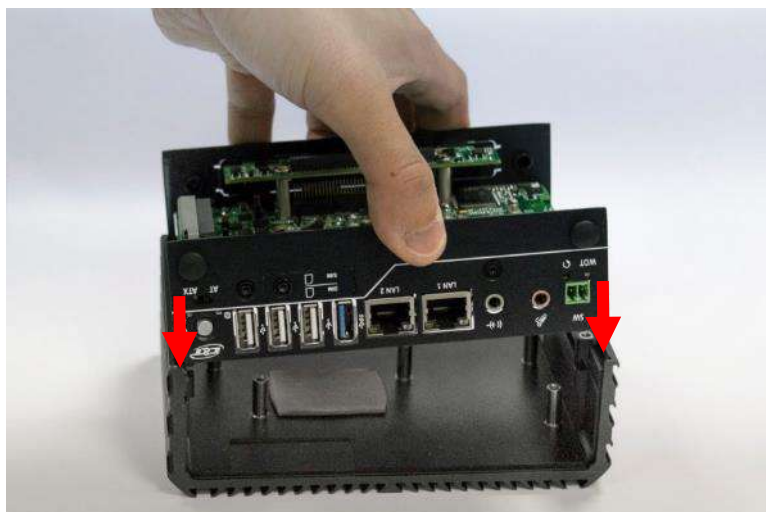

4. Push the system body down until it is firmly in place.



5. Fasten the three screws (M3x5L) and two copper stud (M3x11L) to lock the system body with top cover.

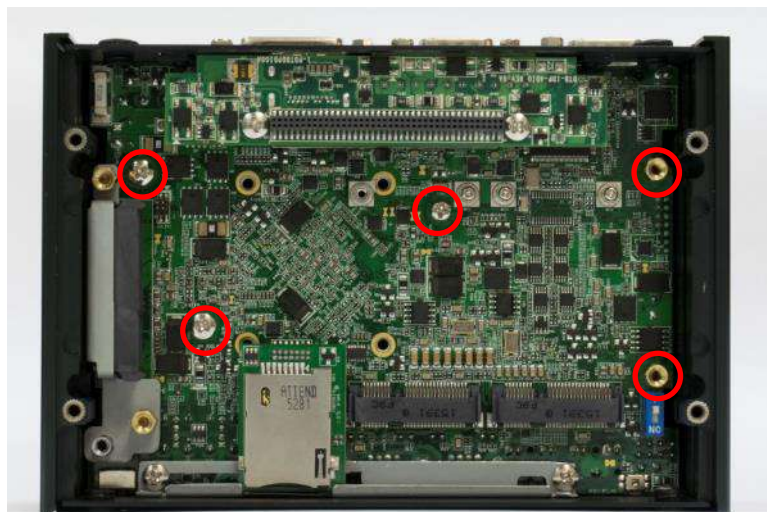

3.9 Installing SATA HDD

1. Lock the 2.5" HDD with HDD bracket using four screws (M3x4L).

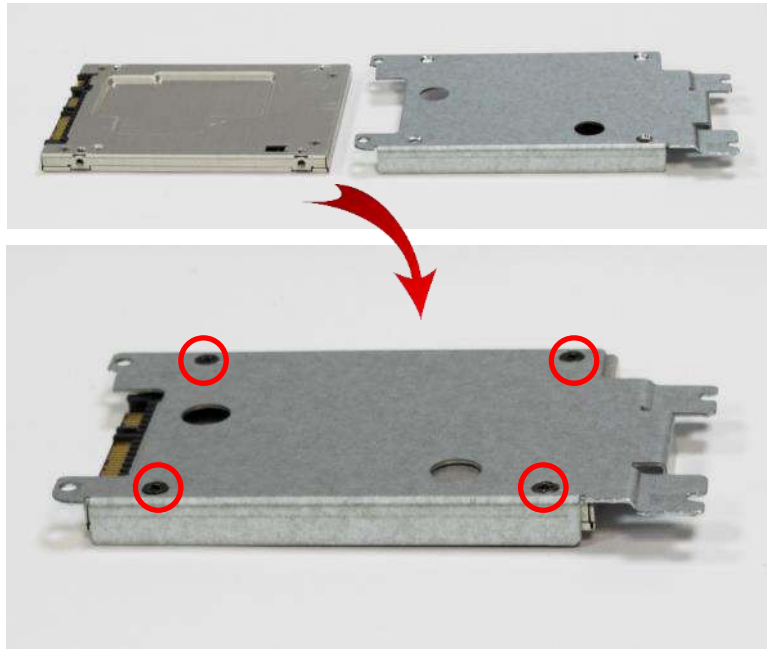

2. Slide the iron plate into the opening on top cover and then place the entire bracket down.



3. Press the entire bracket following the below direction so the SATA connector is firmly plugged into the HDD.



4. Fasten the four screws (M3x5L) to lock the HDD bracket in place.



3.10 Assemble chassis bottom cover

1. Place the bottom cover according to the below direction and make sure the rail is facing inside the system.



2. Lock the bottom cover with the four screws (M3x5L).



3.11 Installing SIM card

1. SIM card socket is located on the front panel of the system. Unscrew one screw (M3x5L) to remove the SIM card socket cover.



2. Now you can insert SIM card into the socket.



3. Please note that the installation of SIM 1 and SIM 2 has to match the installation of mini PCIe sockets.

SIM Card Socket Number	Matching Mini PCIe Slot
SIM 1	Mini PCIe 1
SIM 2	Mini PCIe 2 / mSATA (CN3)

4. To uninstall SIM card, simply press the installed SIM card and then the card will be pushed out.



3.12 Installing wall mount kit

1. Wall mount kit is available for RCO-1000 series included in the standard package.



2. Place the system upside down so you can see the bottom cover. The highlighted screw holes below will be used.



3. Lock the wall mount kit with four screws (M3x5L, Nylok).



3.13 Installing VESA mount kit

1. VESA mount kit is available for RCO-1000 series as optional accessories.



2. Place the system upside down so you can see the bottom cover. The highlighted screw holes below will be used.



3. Place the VESA mount kit (for system) on top of the system aligning the matching screw holes.



4. Lock the VESA mount kit (for system) with four screws (M3x8L, Nylok).



5. VESA mount kit (for panel) should be locked on the back of the panel with four screws.



6. Now the system can be hang in the back of the panel using the hooks.



3.14 Installing side mount kit

1. Side mount kit is available for RCO-1000 series as optional accessories.



2. Place the system upside down so you can see the bottom cover. The highlighted screw holes below will be used.



3. Place the side mount kit on top of the system aligning the matching screw holes.



4. Lock the side mount kit with four screws (M3x8L, Nylok).



3.15 Installing DIN rail holder

1. Din rail holder is available for RCO-1000 series as optional accessories.



2. Place the system upside down so you can see the bottom cover. The highlighted screw holes below will be used.

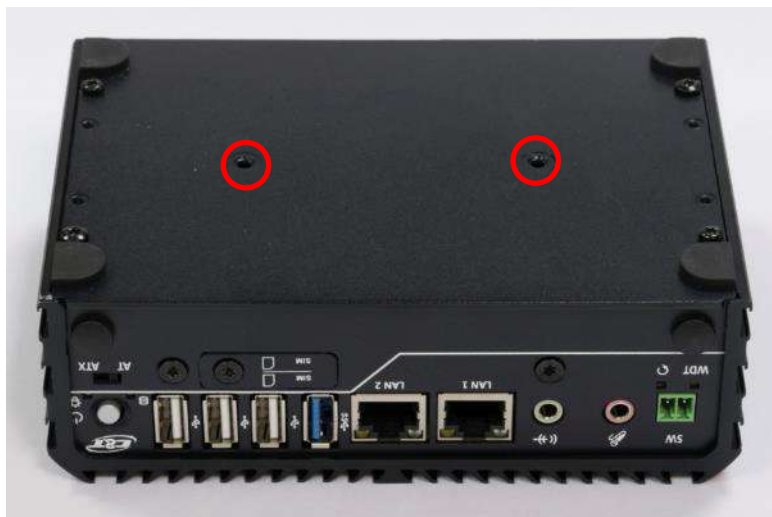

3. Place the din rail holder on top of the bottom cover and lock it with two screws (M4x5L, Nylok).



Chapter 4

BIOS Setup

4.1 BIOS Introduction

The system BIOS software is stored on EEPROM. The BIOS provides an interface to modify the configuration. When the battery is removed, all the parameters will be reset.

BIOS Setup

Power on the embedded system and by pressing or <F2> immediately allows you to enter the setup screens. If the message disappears before you respond and you still wish to enter the Setup, restart the system by turning it OFF and ON or pressing the RESET button.

You may also restart the system by simultaneously pressing <Ctrl>, <Alt>, and <Delete> keys.

Control Keys	
<←> <→>	Select Screen
<↑> <↓>	Select Item
<Enter>	Select
<Page Up/+>	Increases the numeric value or makes changes
<Page Down/->	Decreases the numeric value or makes changes
<F1>	General Help
<F2>	Previous Value
<F3>	Load Optimized Defaults
<F4>	Save Configuration and Exit
<Tab>	Select Setup Fields
<Esc>	Exit BIOS Setup

Main Setup

The main menu lists the setup functions you can make changes to. You can use the arrow keys (↑ ↓) to select the item. The on-line description of the highlighted setup function is displayed at the bottom of the screen.

General Help <F1>

The BIOS setup program provides a General Help screen. You can call up this screen from any menu by simply pressing <F1>. The Help screen lists the appropriate keys to use and the possible selections for the highlighted item. Press <Esc> to exit the Help screen.

4.2 Main Setup

Press to enter BIOS CMOS Setup Utility. The Main setup screen is showed as following when the setup utility is entered. System Date/Time is set up in the Main Menu.

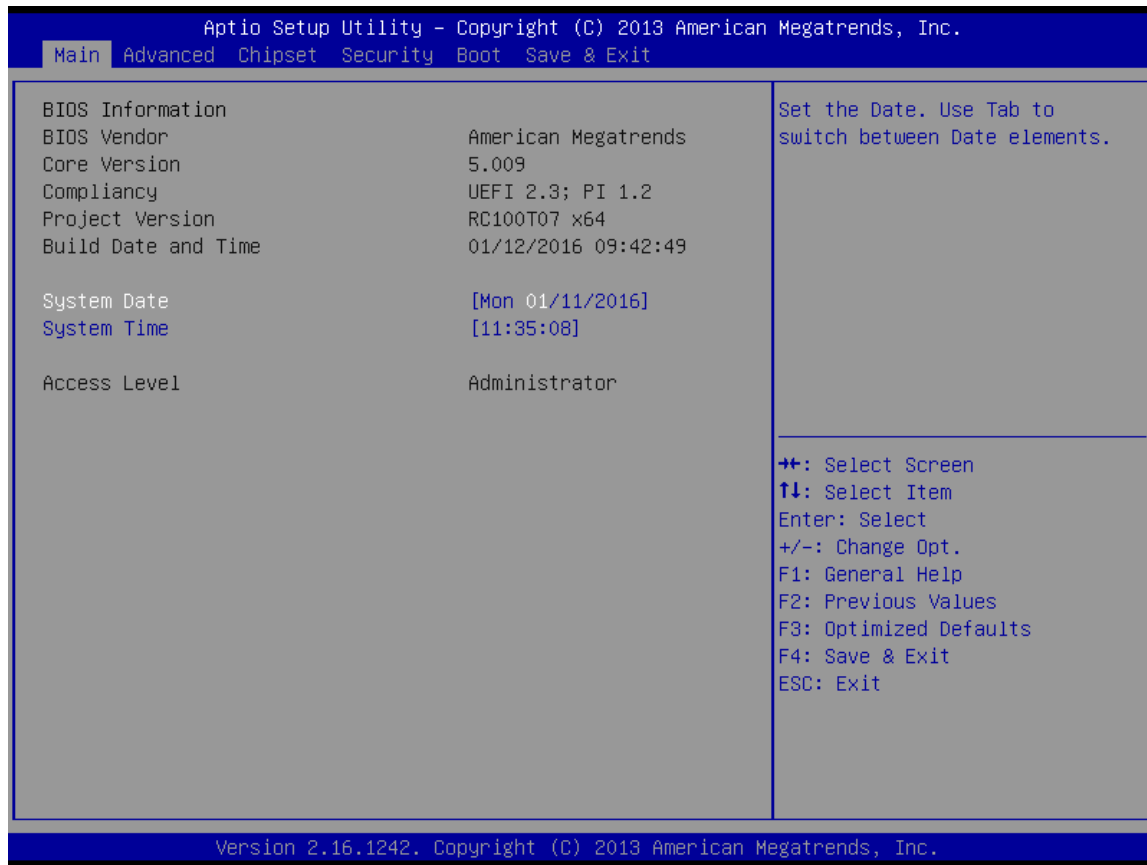

4.2.1 System Date

Set the system date. Please use <Tab> to switch between data elements.

4.2.2 System Time

Set the system time. Please use <Tab> to switch between time elements.

4.3 Advanced Setup

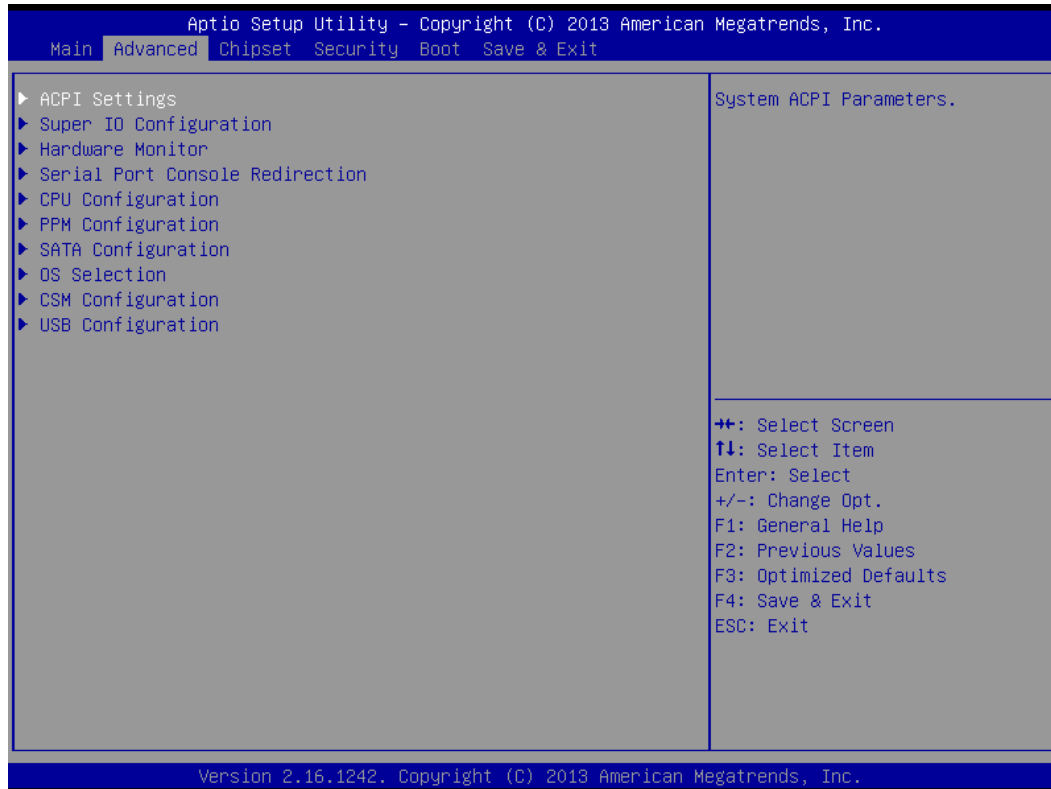

4.3.1 ACPI Settings

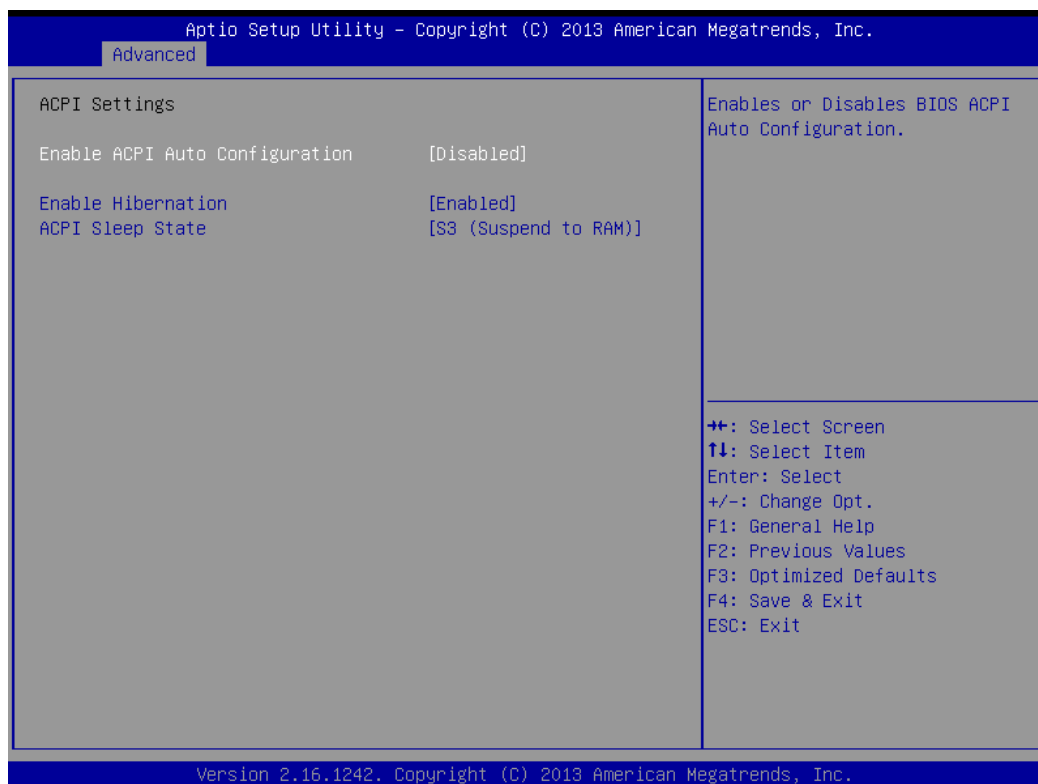

■ Enable ACPI Auto Configuration

This item allows you to enable or disable BIOS ACPI Auto Configuration.

■ Enable Hibernation

This item allows you to enable or disable system ability to hibernate.

■ ACPI Sleep State

This item selects the highest ACPI sleep state the system will enter when the suspend button is pressed. Select <Suspend Disabled> or <S3 (Suspend to RAM)>.

4.3.2 Super IO Configuration

This setting allows you to select options for the Super IO Configuration, and change the value of the selected option.

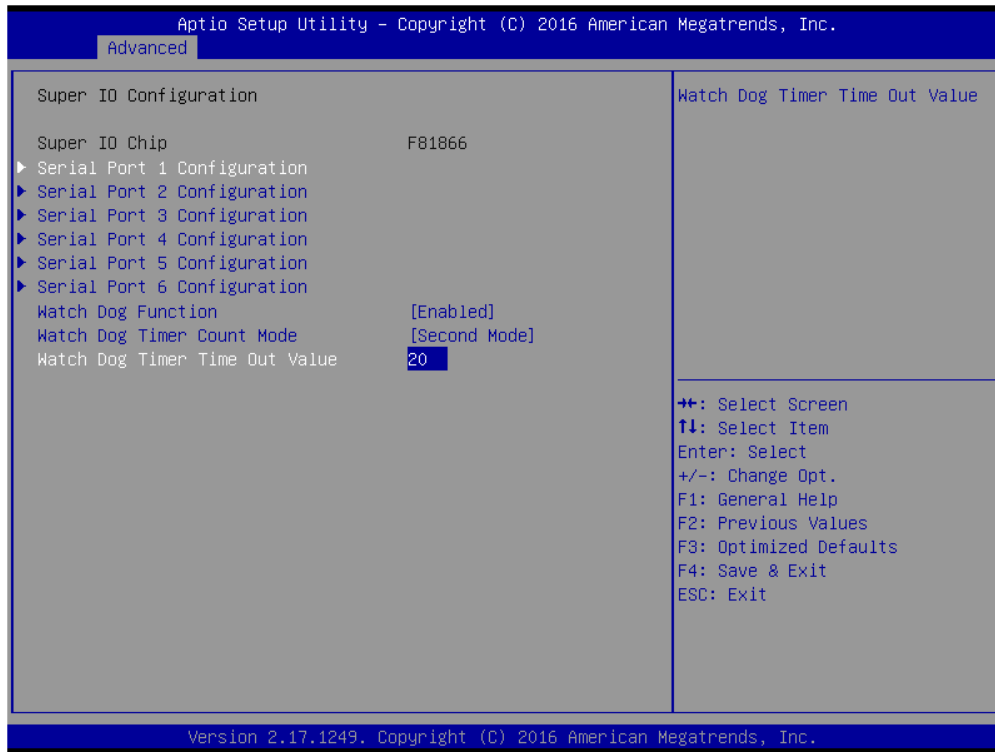

Serial Port 1 Configuration

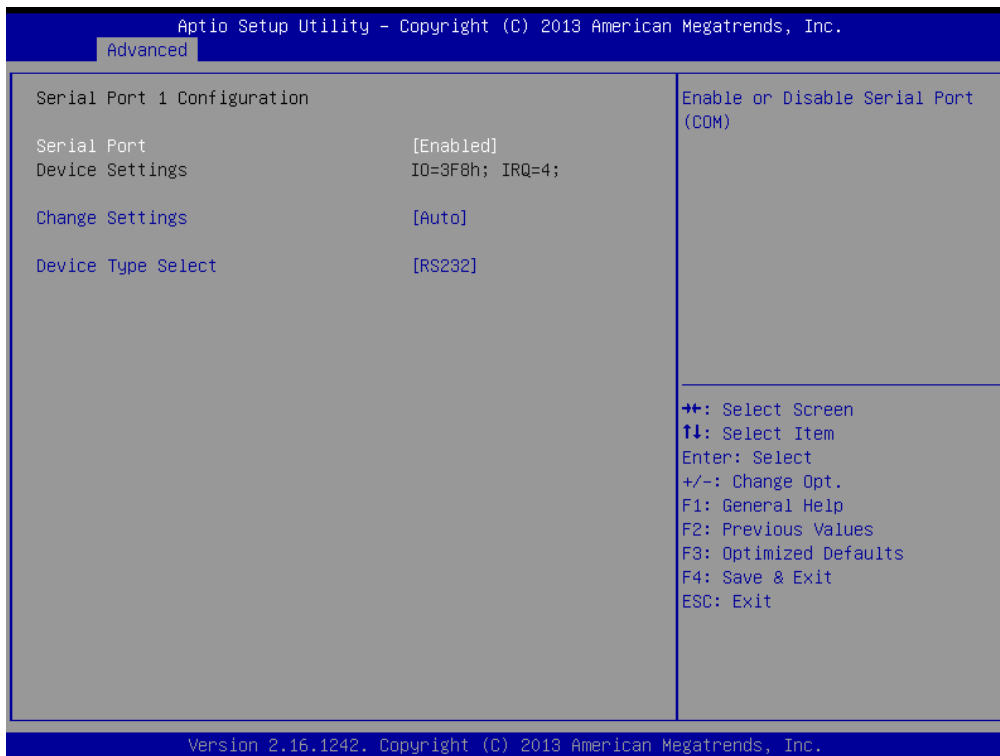

Serial Port

This item allows you to enable or disable serial port.

Change Settings

This item allows you to change the address & IRQ settings of the specified serial port.

Device Type Select

Change the Serial interface. Select <RS232> ,<RS422 Full Duplex> or <RS485 Half Duplex> interface.

Serial Port 2 Configuration

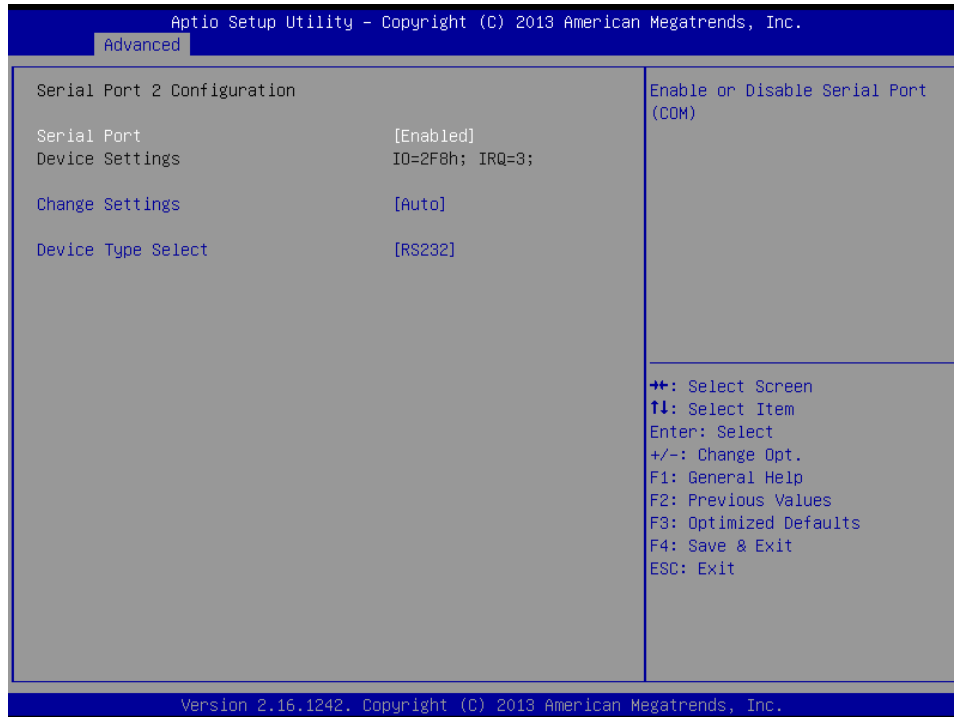

Serial Port

This item allows you to enable or disable serial port.

Change Settings

This item allows you to change the address & IRQ settings of the specified serial port.

Device Type Select

Change the Serial interface. Select <RS232> ,<RS422 Full Duplex> or <RS485 Half Duplex> interface.

Serial Port 3 Configuration

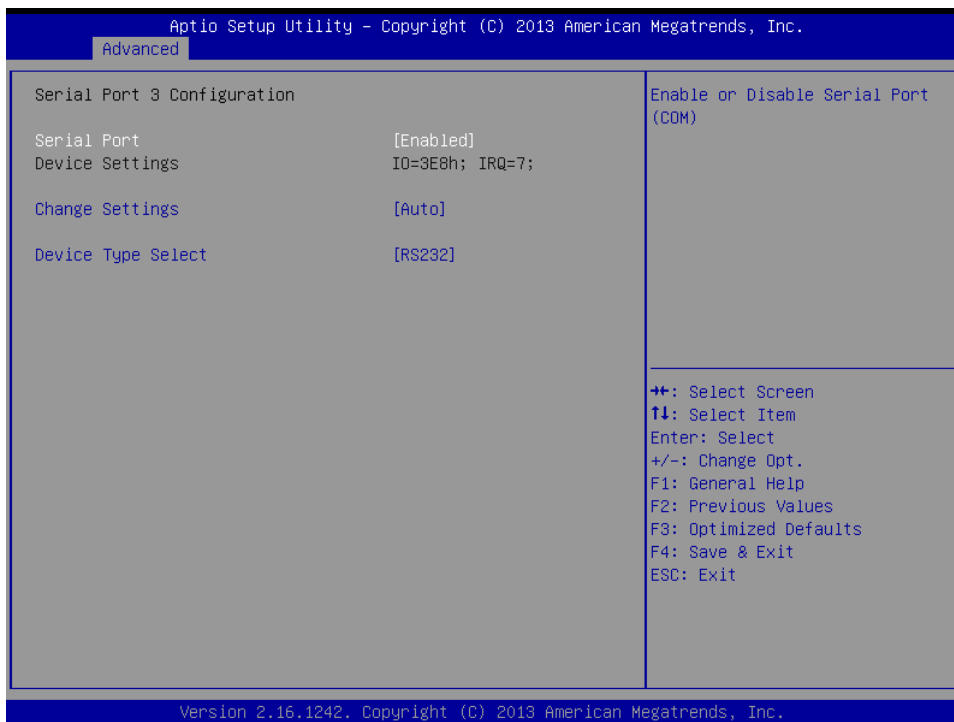

Serial Port

This item allows you to enable or disable serial port.

Change Settings

This item allows you to change the address & IRQ settings of the specified serial port.

Device Type Select

Change the Serial interface. Select <RS232> ,<RS422 Full Duplex> or <RS485 Half Duplex> interface.

Serial Port 4 Configuration

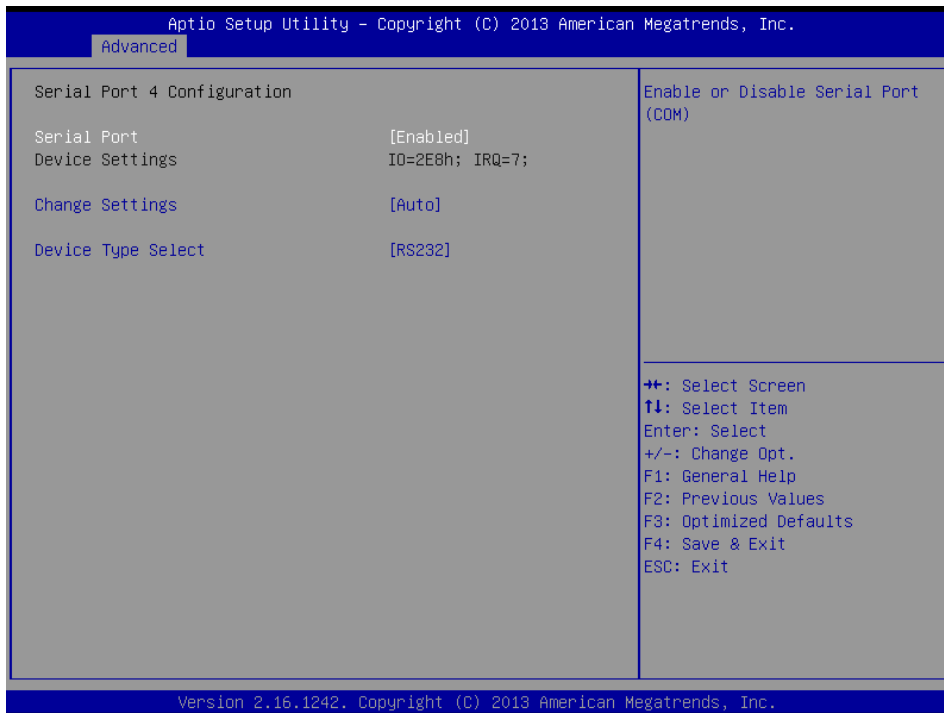

Serial Port

This item allows you to enable or disable serial port.

Change Settings

This item allows you to change the address & IRQ settings of the specified serial port.

Device Type Select

Change the Serial interface. Select <RS232> ,<RS422 Full Duplex> or <RS485 Half Duplex> interface.

Serial Port 5 Configuration

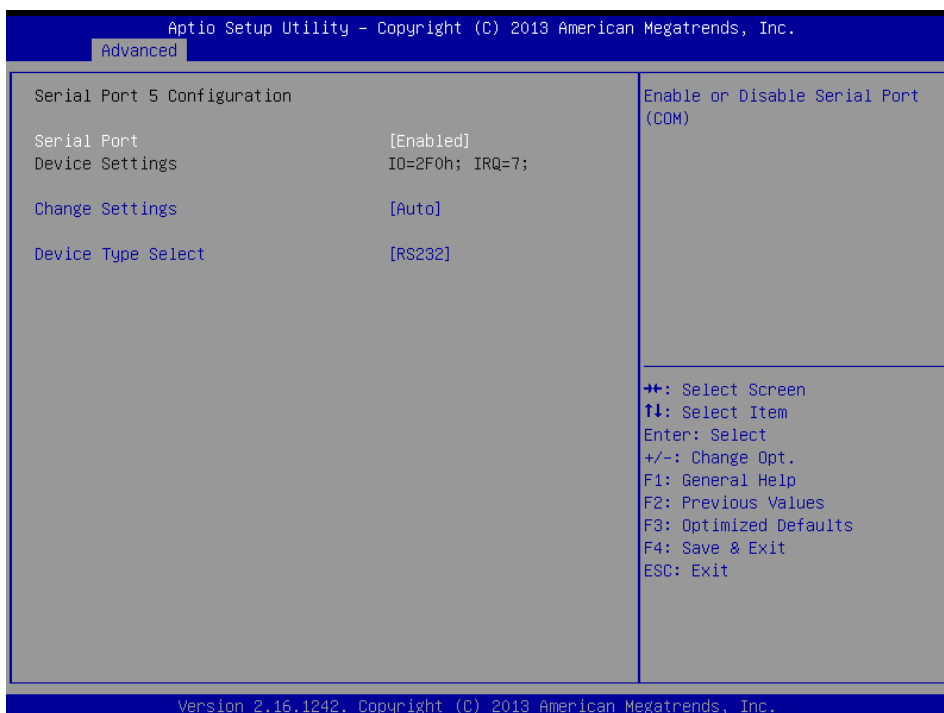

Serial Port

This item allows you to enable or disable serial port.

Change Settings

This item allows you to change the address & IRQ settings of the specified serial port.

Device Type Select

Change the Serial interface. Select <RS232> ,<RS422 Full Duplex> or <RS485 Half Duplex> interface.

Serial Port 6 Configuration

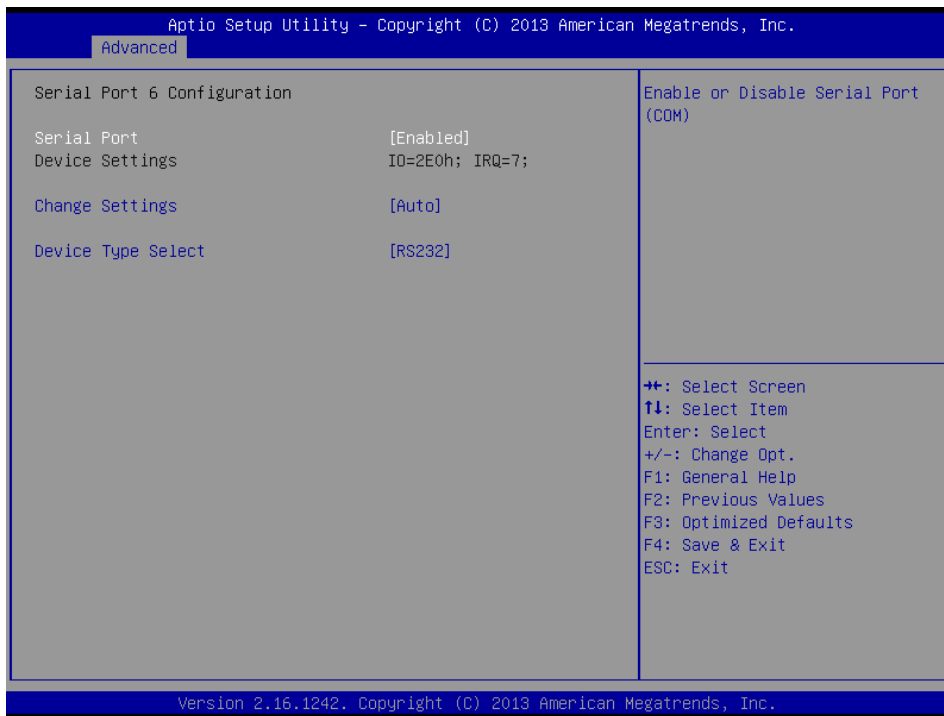

Serial Port

This item allows you to enable or disable serial port.

Change Settings

This item allows you to change the address & IRQ settings of the specified serial port.

Device Type Select

Change the Serial interface. Select <RS232> ,<RS422 Full Duplex> or <RS485 Half Duplex> interface.

Watch Dog Function

This setting allows you to setup the system watch-dog timer, a hardware timer that generates a reset when the software that it monitors does not respond as expected each time the watch dog polls it.

Watch Dog Timer Count Mode

Change the Watch dog mode. Select <Second Mode> or <Minute Mode> mode.

Watch Dog Timer Time Out Value

User can set a value in the range of 0 to 255.

4.3.3 Hardware Monitor

These items display the current status of all monitored hardware devices/ components such as voltages and temperatures.

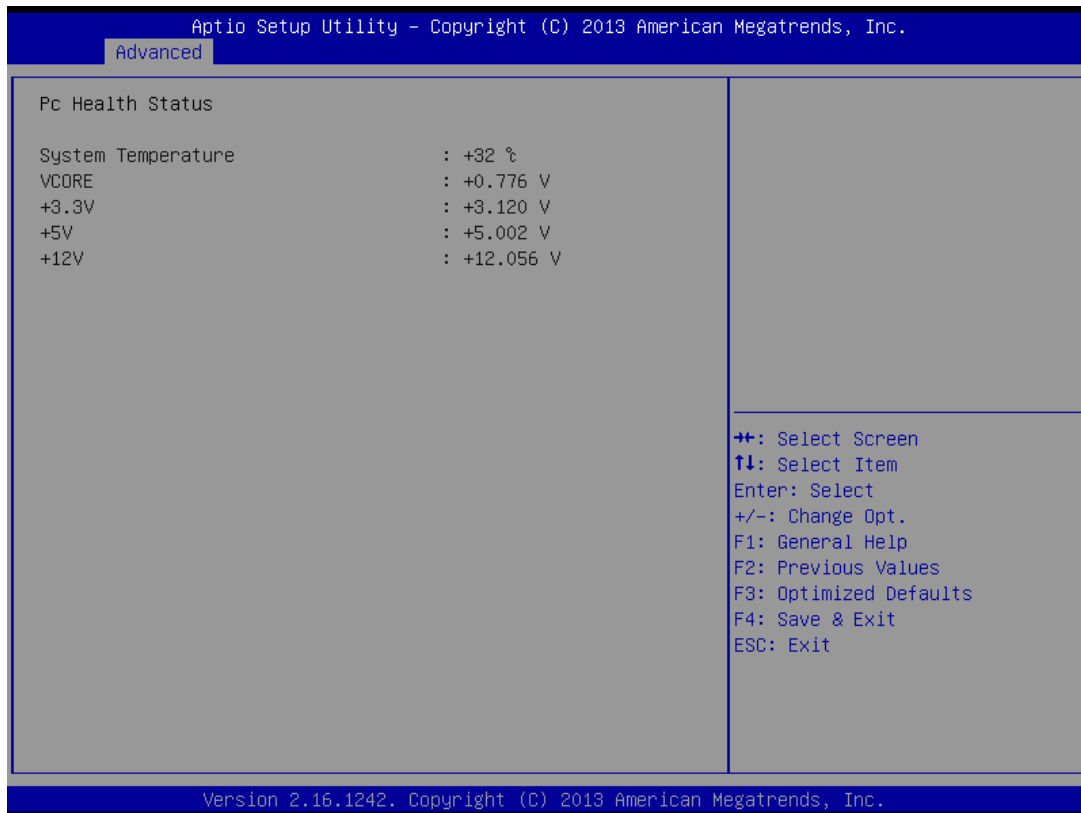

4.3.4 Serial Port Console Redirection

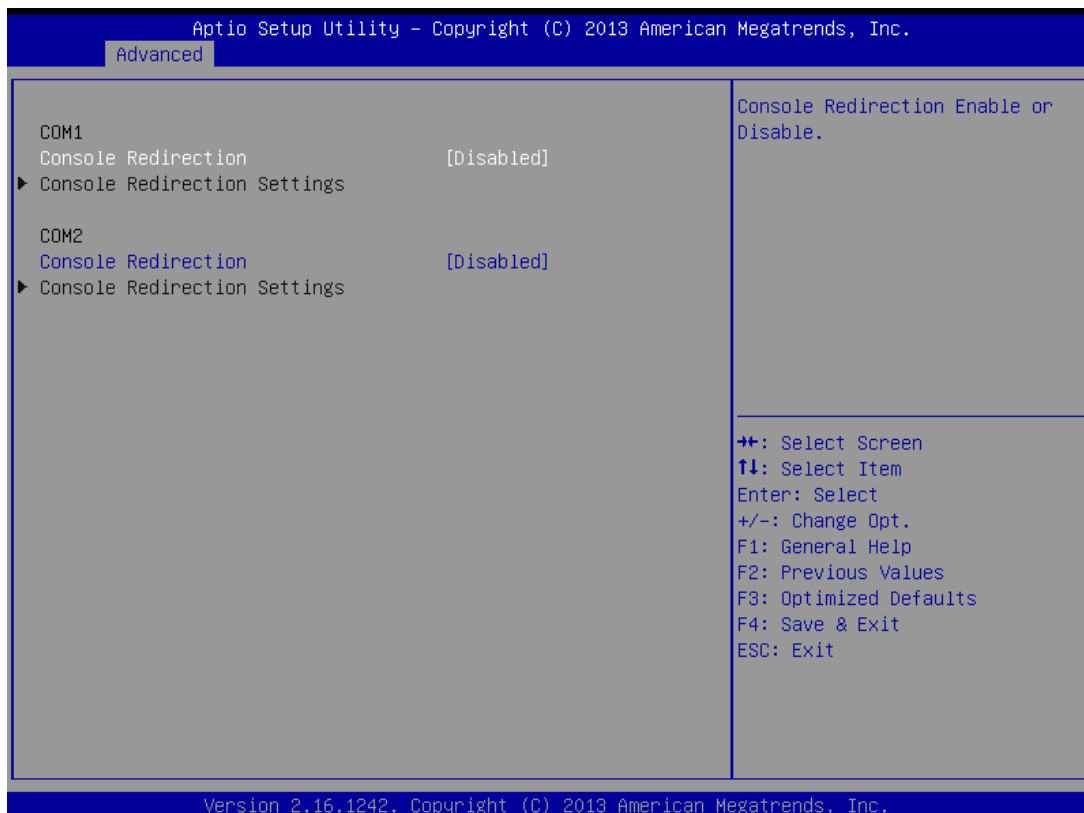

■ Console Redirection

These items allow you to enable or disable COM1~COM6 console redirection.

4.3.5 CPU Configuration

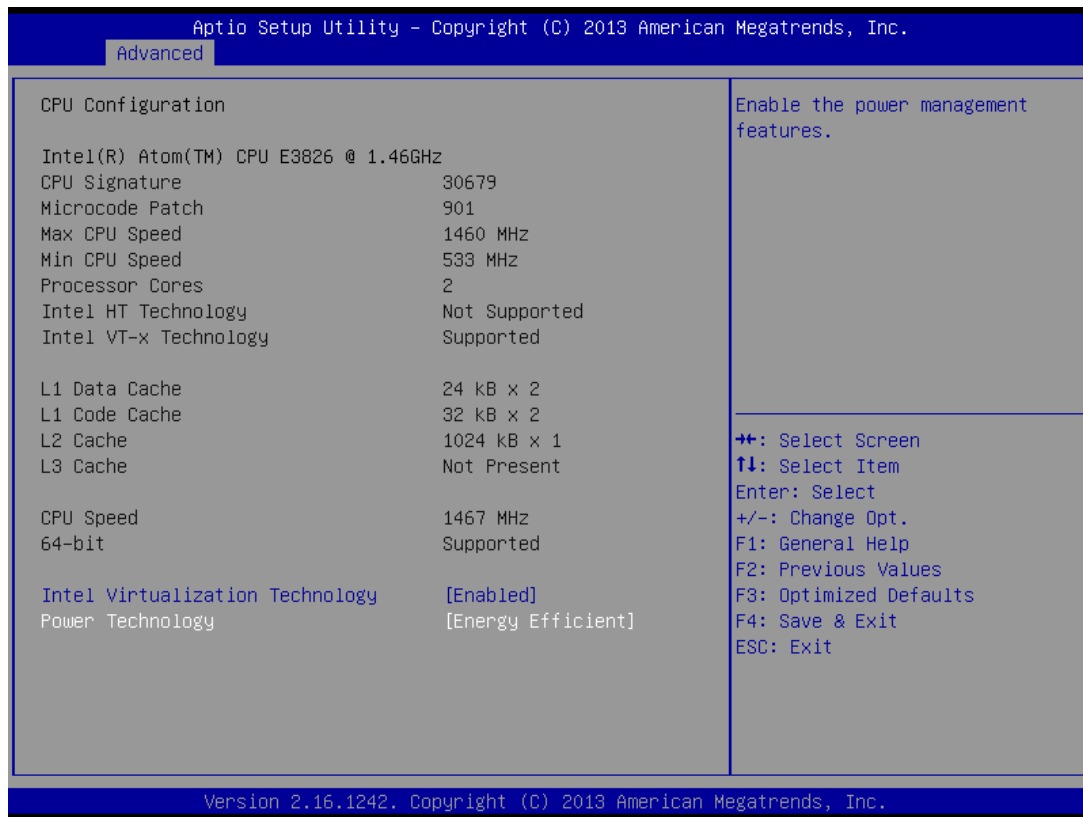

■ Intel Virtualization Technology

Virtualization enhanced by Intel Virtualization Technology will allow a platform to run multiple operating systems and applications in independent partitions. With virtualization, one computer system can function as multiple Virtual systems.

■ Power Technology

This item allows you to configure the power management features. Select <Disable>, <Energy Efficient> or <Custom>.

4.3.6 PPM Configuration

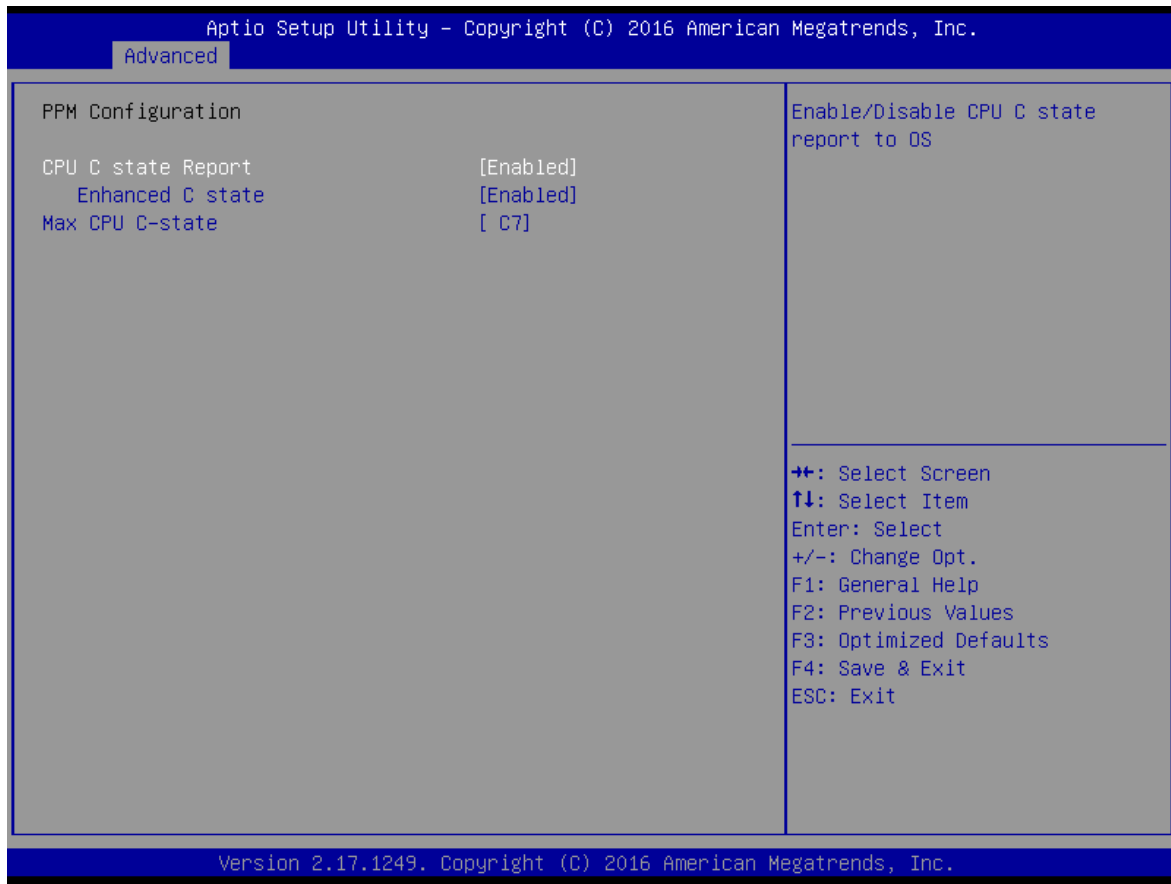

■ CPU C state Report

Enables or disables support for CPU's power-saving functions.

■ Enhanced C state

Enables or disables Intel CPU Enhanced Halt (C1E) function, a CPU power-saving function in system halt state. When enabled, the CPU core frequency and voltage will be reduced during system halt state to decrease power consumption. This item is configurable only when CPU C state Report is enabled.

■ Max CPU C-state

This item allows you to determine the maximum C state that the CPU will support.

4.3.7 SATA Configuration

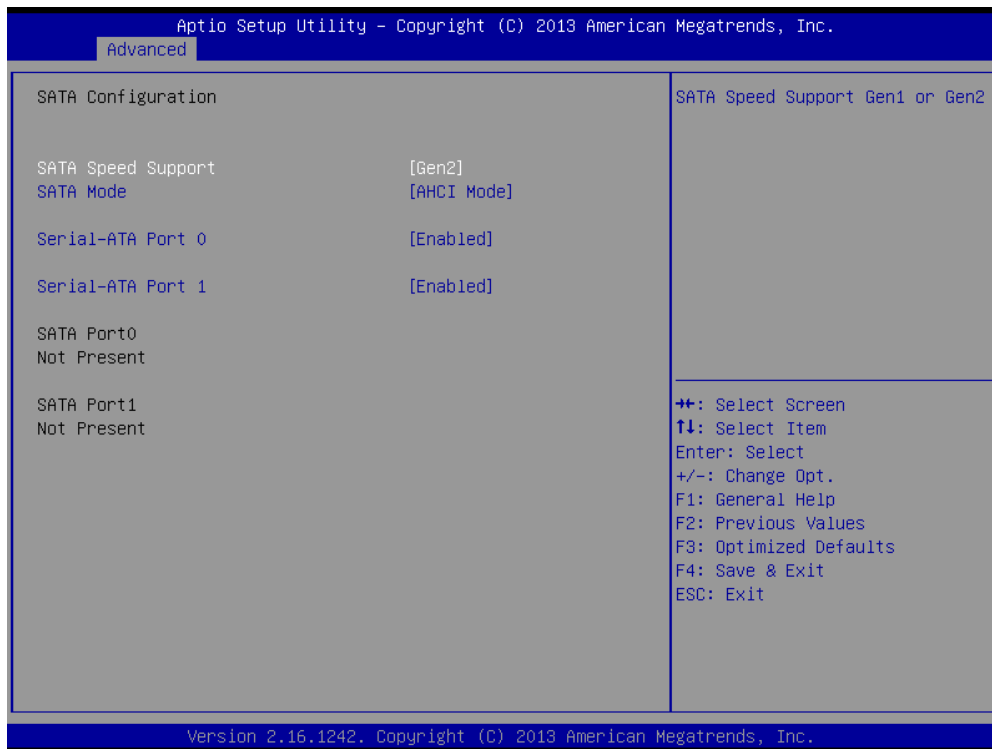

■ SATA Speed Support

Change the SATA Speed. Select <Gen1> or <Gen2> speed.

■ SATA Mode

This item allows you to select IDE or AHCI Mode.

■ Serial – ATA Port 0

This item allows you to enable or disable Serial-ATA Port 0.

■ Serial – ATA Port 1

This item allows you to enable or disable Serial-ATA Port 1.

4.3.8 OS Selection



4.3.9 CSM Configuration

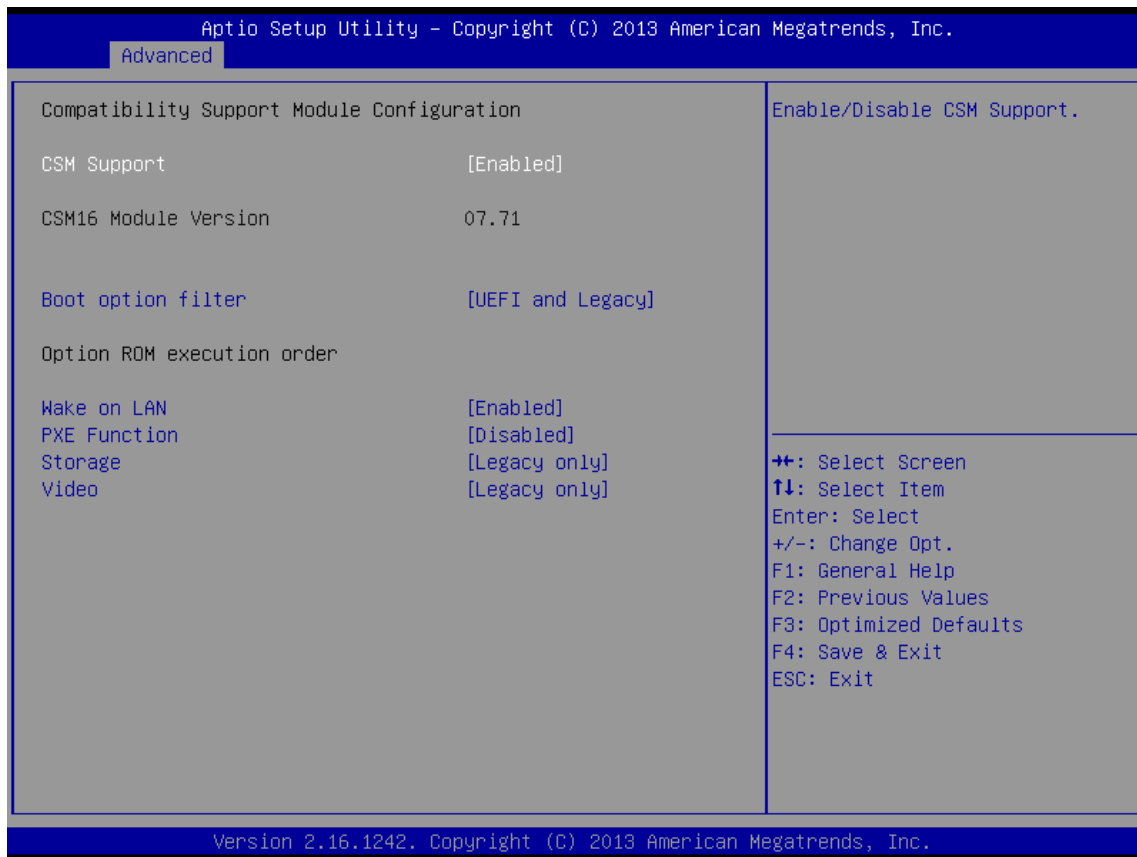

■ CSM Support

Enables or disables UEFI CSM (Compatibility Support Module) to support a legacy PC boot process.

■ Boot option filter

This item allows you to select which type of operating system to boot.

UEFI and Legacy: Allows booting from operating systems that support legacy option ROM or UEFI option ROM.

Legacy only: Allows booting from operating systems that only support legacy option ROM.

UEFI only: Allows booting from operating systems that only support UEFI option ROM.

This item is configurable only when CSM Support is set to Enabled.

■ Wake on LAN

This item allows you to enable or disable wake on LAN function.

■ PXE Function

This item allows you to enable or disable PXE function.

■ Storage

This setting allows you to select whether to enable the UEFI or legacy option ROM for the storage device controller.

Do not launch: Disables option ROM.

UEFI only: Enables UEFI option ROM only.

Legacy only: Enables legacy option ROM only.

■ Video

This item allows you to select whether to enable the UEFI or legacy option ROM for the storage device controller.

Do not launch: Disables option ROM.

UEFI only: Enables UEFI option ROM only.

Legacy only: Enables legacy option ROM only.

4.3.10 USB Configuration

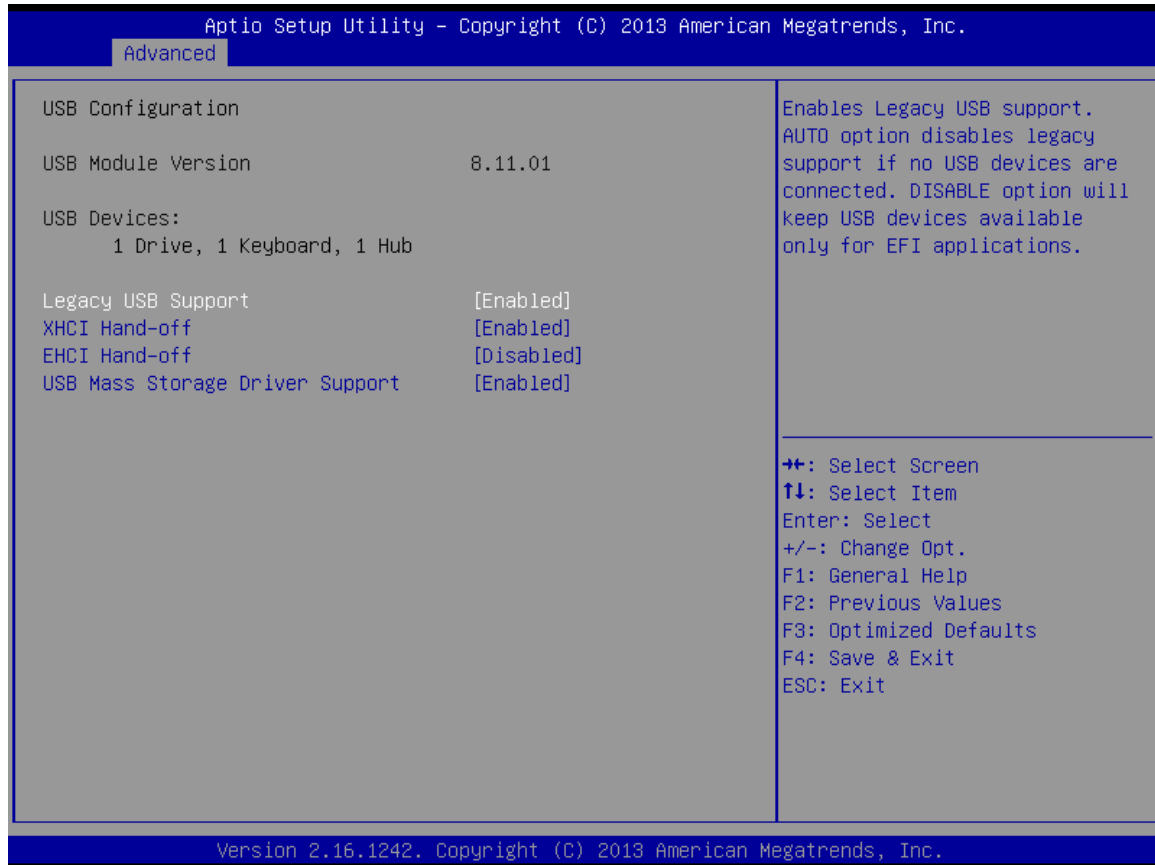

■ Legacy USB Support

Allows USB keyboard/ mouse to be used in MS-DOS.

■ XHCI Hand-off

Determines whether to enable XHCI (USB3.0) Hand-off feature for an operating system without XHCI (USB3.0) Hand-off support.

■ EHCI Hand-off

Determines whether to enable EHCI Hand-off feature for an operating system without EHCI Hand-off support.

■ USB Mass Storage Driver Support

Enables or disables support for USB storage devices.

4.4 Chipset



4.4.1 North Bridge

This section provides information on the installed memory size and memory/onboard graphics-related configuration options.



■ Intel IGD Configuration

This section provides onboard graphics-related configuration options.

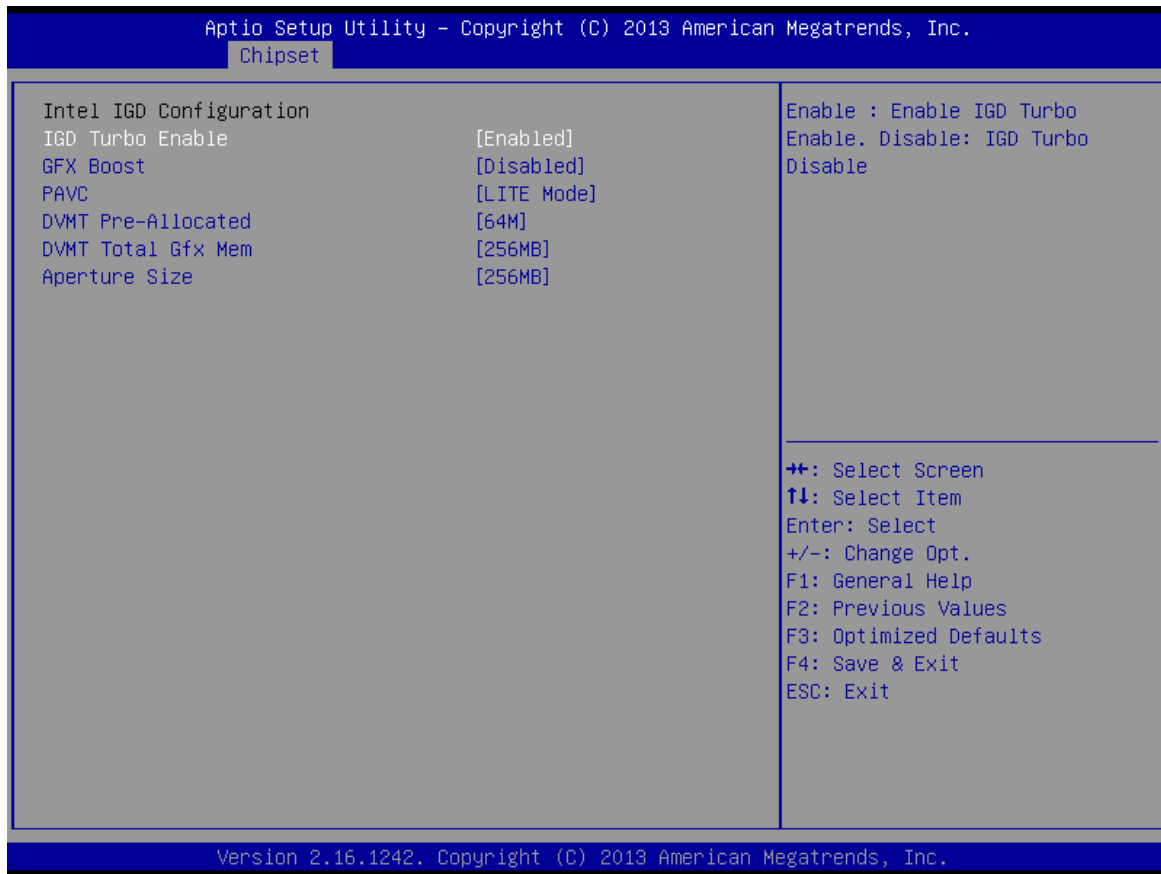

IGD Turbo Enable

This item allows you to enable or disable IGD Turbo.

GFX Boost

This item allows you to enable or disable GFX Boost.

PAVC

This item enables/disables Protected Audio Video Control. Select <Disabled>, <LITE Mode> or <SERPENT Mode>.

DVMT Pre-Allocated

This item selects DVMT 5.0 Pre-Allocated (Fixed) Graphics Memory size used by the Internal Graphics Device. . Select <64M>, <96M>, <128M>, <160M>, <192M>, <224M>, <256M>, <288M>, <320M>, <352M>, <384M>, <416M>, <448M>, <480M> or <512M>.

DVMT Total Gfx Mem

This item selects DVMT5.0 Total Graphic Memory size used by the Internal Graphics Device. Select <128MB>, <256MB> or <Max>.

Aperture Size

This item selects the Aperture Size. Select <128MB>, <256MB> or <512MB>.

4.4.2 South Bridge

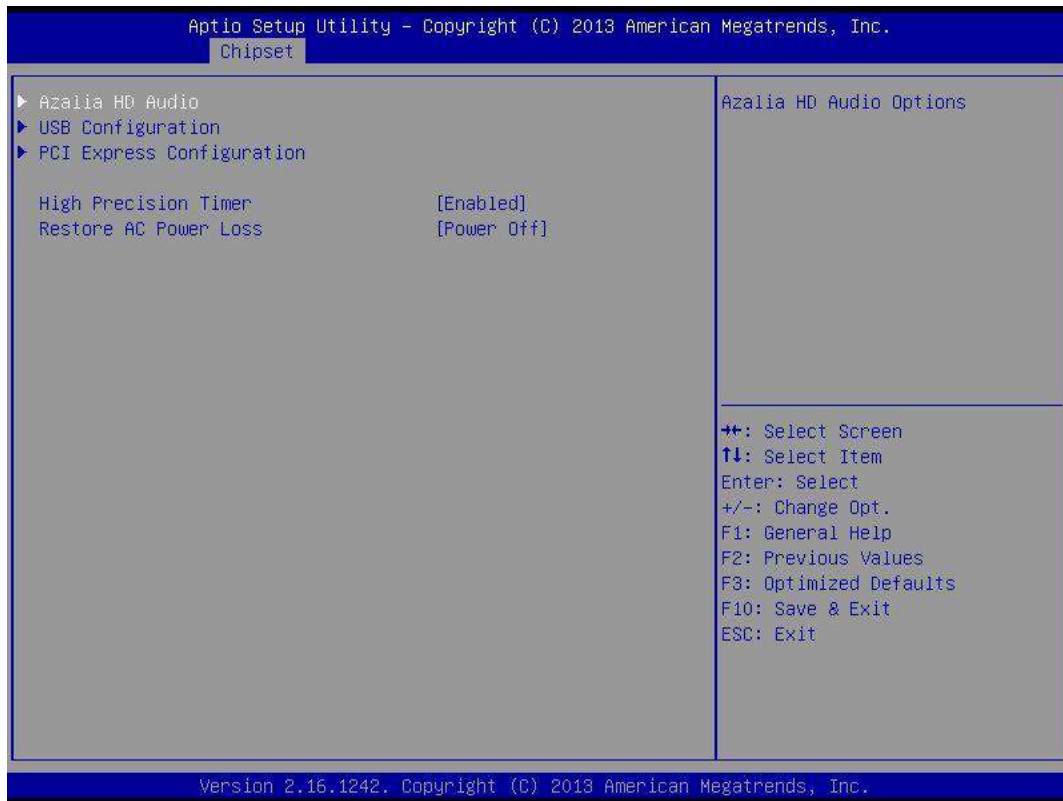

■ Azalia HD Audio

Control detection of the Azaliadevice.

Audio Controller

Enabled: Azalia will be unconditionally enabled.

Disabled: Azalia will be unconditionally disabled.

■ USB Configuration

XHCI Mode

This item allows you to enable or disable the USB XHCI controller.

USB 2.0 (EHCI) Support

This item allows you to enable or disable the USB EHCI support.

■ PCI Express Configuration

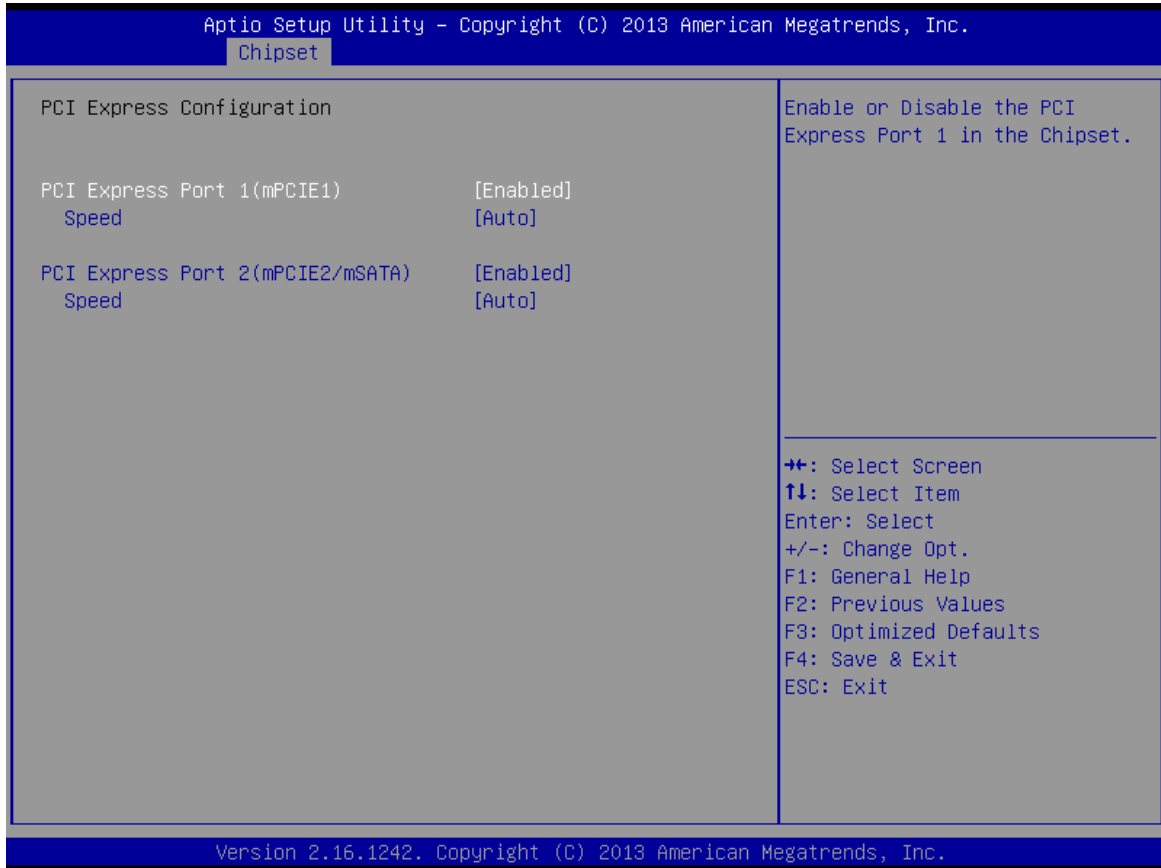

PCI Express Port 1 (mPCIIE1)

This item allows you to enable or disable PCI Express Port 1 (mPCIIE1) in the Chipset.

Speed

Change the PCIe Port Speed. Select <AUTO> ,<Gen 2> or <Gen 1>

PCI Express Port 2 (mPCIIE2/mSATA)

This item allows you to enable or disable PCI Express Port 2 (mPCIIE2/mSATA) in the Chipset.

Speed

Change the PCIe Port Speed. Select <AUTO> ,<Gen 2> or <Gen 1>

■ High Precision Timer

Enable or disable High Precision Event Timer (HPET) in the operating system.

■ Restore AC Power Loss

This item specifies whether your system will reboot after a power failure or interrupt occurs. Available settings are:

Power Off: Leave the computer in the power off state.

Power On: Leave the computer in the power on state.

Last State: Restore the system to the previous status before power failure or interrupt occurred.

4.5 Security

Security menu allow you to change administrator password and user password settings.

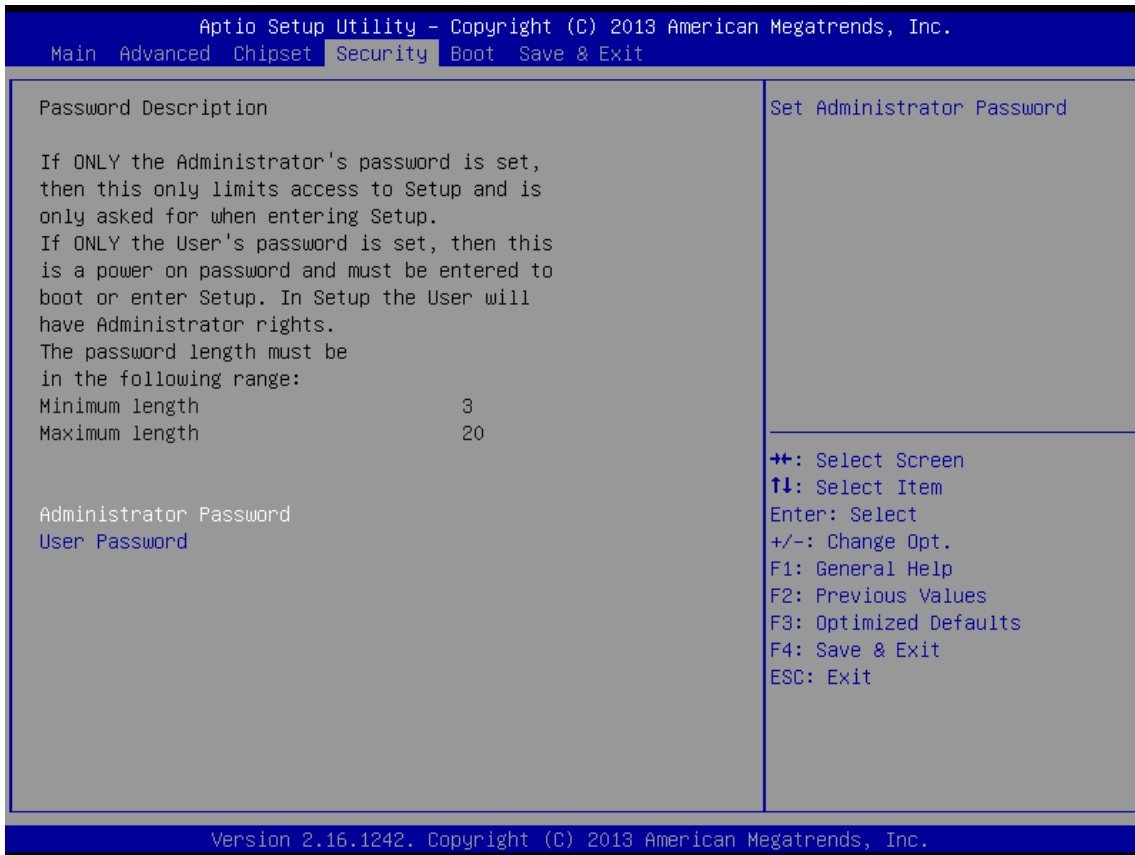

4.5.1 Administrator Password

This item allows you to set Administrator Password.

4.5.2 User Password

This item allows you to set User Password.

4.6 Boot

This menu allows you to setup the system boot options.

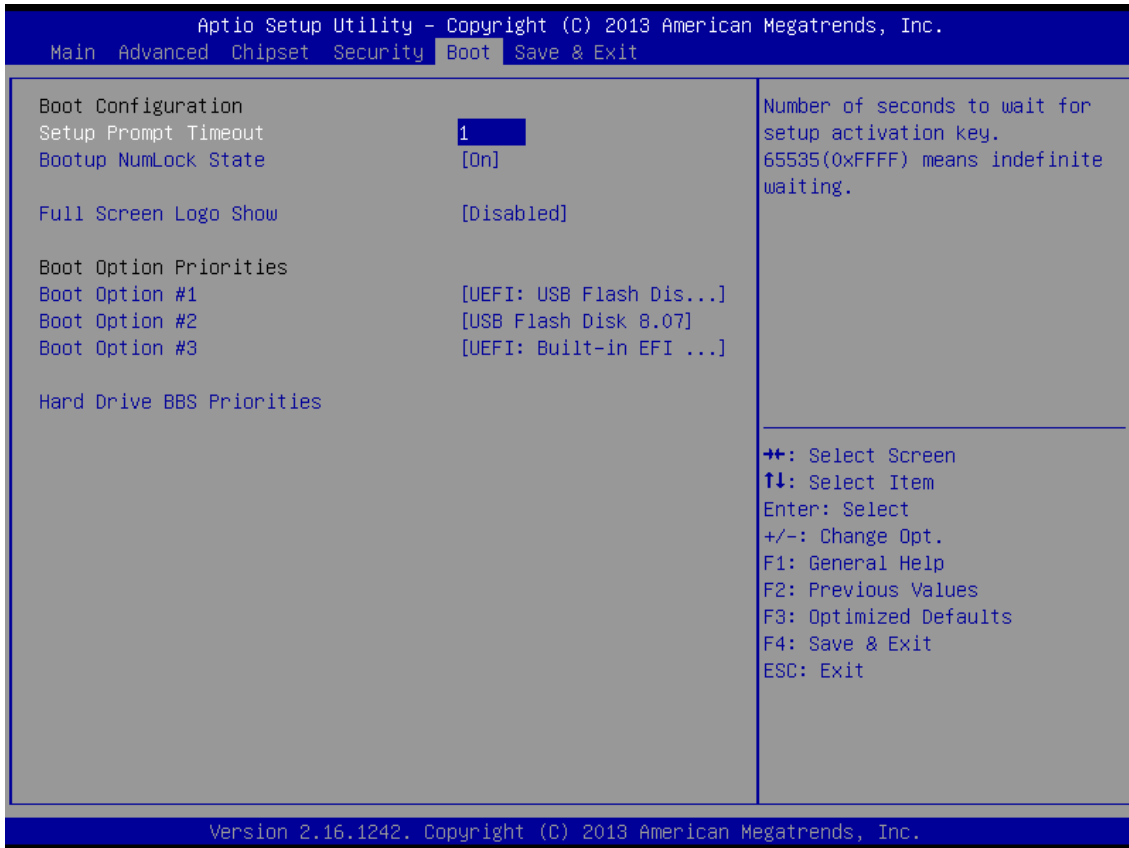

4.6.1 Setup Prompt Timeout

This item sets number of seconds to wait for setup activation key.

4.6.2 Bootup NumLock State

This item selects the keyboard NumLock state. Select <On> or <Off>.

4.6.3 Full Screen Logo Show

This item allows you to enable or disable Full Screen Logo Show function.

4.6.4 Boot Option Priorities

The items specify the boot device priority sequence from the available devices. The number of device items that appears on the screen depends on the number of devices installed in the system.

4.7 Save & Exit

This setting allows you to configure the boot settings.

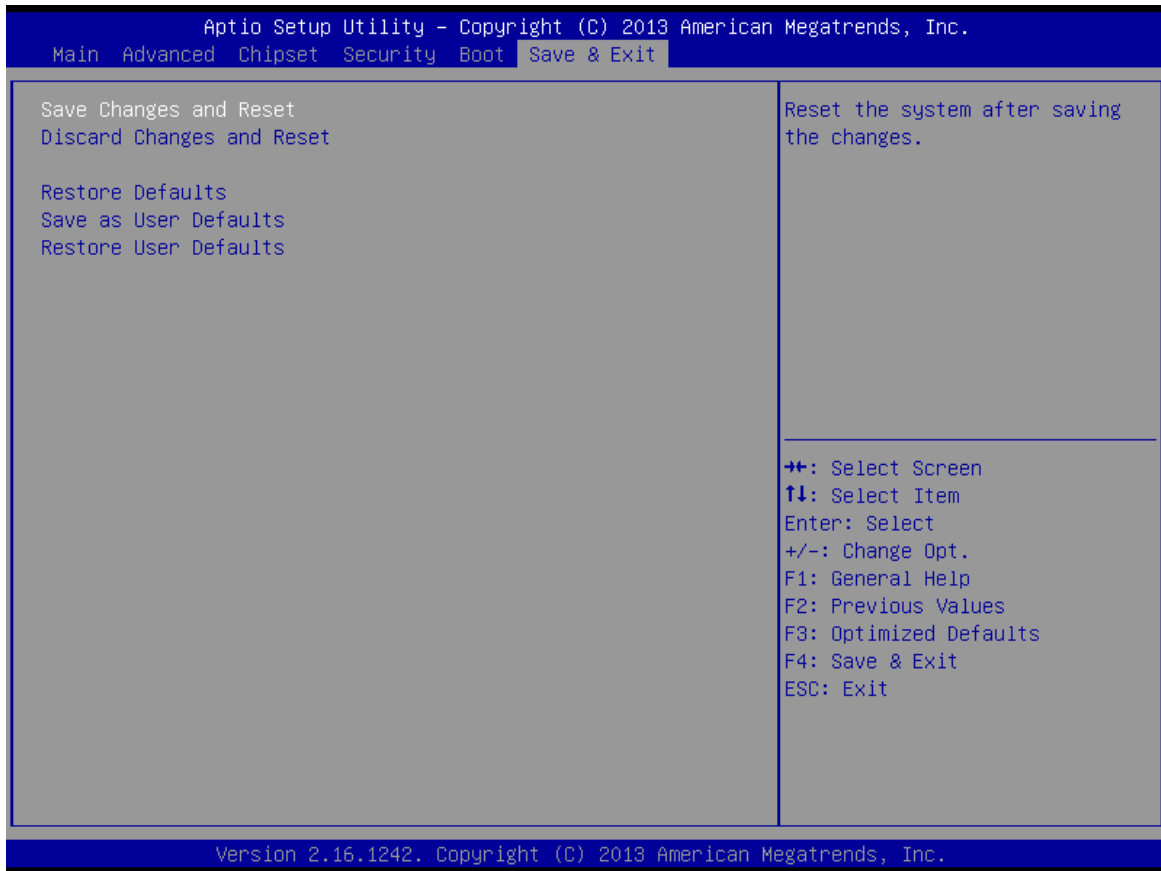

4.7.1 Save Changes and Reset

This item allows you reset the system after saving the changes.

4.7.2 Discard Changes and Reset

Select this option to quit Setup without making any permanent changes to the system configuration.

4.7.3 Restore Defaults

This selection allows you to reload the BIOS when problem occurs during system booting sequence. These configurations are factory settings optimized for this system.

4.7.4 Save as User Defaults

When users have completed system configuration, select this option to save changes as user defaults without exit BIOS setup menu.

4.7.5 Restore User Defaults

Use this item to restore defaults to all the setup options.

Appendix

WDT & GPIO

This appendix provides the sample codes of WDT (Watch Dog Timer) and GPIO (General Purpose Input/ Output).

WDT Sample Code

WDT Setting

```
// IO Address 0xA16 is time value
// IO Address 0xA15 is WDT enable and configuration
Example, Set 0xA16=0x03, 0xA15=0x31, it will reset after 3 seconds
```

```
#define TimePort          0xA16
#define TimeEnablePort    0xA15
```

```
WriteByte (TimePort,0x03)
WriteByte (TimeEnablePort,0x31)
```

Watchdog Timer Configuration Register 1 – base address + 05h

Bit	Name	R/W	Reset	Default	Description
7	Reserved	R	-	0	Reserved
6	WDTMOUT_STS	R/W	5VSB	0	If watchdog timeout event occurred, this bit will be set to 1. Write a 1 to this bit will clear it to 0.
5	WD_EN	R/W	5VSB	0	If this bit is set to 1, this counting of watchdog time is enabled.
4	WD_PULSE	R/W	5VSB	0	Select output mode (0: level, 1: pulse) of RSTOUT# by setting this bit.
3	WD_UNIT	R/W	5VSB	0	Select time unit (0: 1 sec, 1: 60 sec) of watchdog timer by setting this bit.
2	WD_HACTIVE	R/W	5VSB	0	Select output polarity of RSTOUT# (1: high active, 0: low active) by setting this bit.
1-0	WD_PSWIDTH	R/W	5VSB	0	Select output pulse width of RSTOUT# 0: 1 ms 1: 25 ms 2: 125 ms 3: 5 sec

Watchdog Timer Configuration Register 2 – base address + 06h

Bit	Name	R/W	Reset	Default	Description
7-0	WD_TIME	R/W	5VSB	0	Time of watchdog timer

GPIO Sample Code

GPIO Setting

IO_DO4	I/O 0xA02h Bit3
IO_DO3	I/O 0xA02h Bit2
IO_DO2	I/O 0xA02h Bit1
IO_DO1	I/O 0xA02h Bit0
IO_DI4	I/O 0xA03h Bit7
IO_DI3	I/O 0xA03h Bit6
IO_DI2	I/O 0xA03h Bit5
IO_DI1	I/O 0xA03h Bit4

```
#define GPI_ADDR 0xA03
#define GPO_ADDR 0xA02h
```

- // 0xA03h is Pin Status(default 0xF5)(at IO_DI1~ IO_DI4)
ByteData = ReadByte (GPI_ADDR) //Read current Pin Status
- //Offset 0xA02h default setting is 0xFF (output pin set to output high) (at IO_DO1~ IO_DO4)
ByteData = 0x0F //set IO_DO1~ IO_DO4 to high
WriteByte (GPO_ADDR, ByteData)

