

USER'S MANUAL

VCO-6131E-4M2

Superior Fanless Embedded System



Table of Contents

Prefaces	04
Revision	04
Disclaimer	04
Copyright Notice	04
Trademarks Acknowledgment	04
Environmental Protection Announcement	04
Safety Precautions	05
Technical Support and Assistance	06
Conventions Used in this Manual	06
Package Contents	07
Ordering Information	07
Optional Accessory	07
Chapter 1 Product Introductions	08
1.1 Overview	09
1.1.1 Key Feature	09
1.2 Hardware Specification	10
1.3 System I/O	11
1.4 Mechanical Dimension	13
Chapter 2 Switches and Connectors	14
2.1 Switch and connector Locations	15
2.1.1 Top View	15
2.1.2 Bottom View	16
2.2 Connector / Switch Definition	17
2.3 I/O Interface Descriptions.....	18
Chapter 3 System Setup	53
3.1 Set torque force to 3.5 kgf-cm to execute all the screwing and unscrewing	54
3.2 Removing chassis bottom cover	54
3.3 Disconnecting expansion module from computing module.....	56
3.4 Removing chassis top cover	57
3.5 Install HDD/SSD on the internal SATA bay.....	58
3.6 Installing HDD on removable SATA HDD bay.....	60
3.7 Installing SODIMM.....	62
3.8 Installing CPU.....	63
3.9 Installing Mini PCIe card / mSATA.....	68
3.10 Installing M.2 2280 NVMe SSD	69
3.11 Installing WiFi Module.....	70
3.12 Installing Mini PCIe card / 4GLTE.....	73
3.13 Installing antenna.....	74
3.14 Installing graphic Card.....	76
3.15 AC Adapter with 4P terminal block	77
3.16 AC Adapter with 4P terminal block	78

Chapter 4	BIOS Setup	90
4.1	BIOS Introduction	91
4.2	Main Setup	92
4.3	Advanced Setup	93
4.3.1	Connectivity Configuration	94
4.3.2	CPU Configuration	95
4.3.3	PCH-FW Configuration	96
4.3.4	SATA and RST Configuration	97
4.3.5	RST (UEFI RAID) Configuration	98
4.3.6	Trusted Computing	100
4.3.7	ACPI Settings	101
4.3.8	Super IO Configuration	102
4.3.9	Hardware Monitor	109
4.3.10	Serial Port Console Redirection	111
4.3.11	Network Stack Configuration	112
4.3.12	CSM Configuration	113
4.3.13	USB Configuration	114
4.4	Chipset	115
4.4.1	System Agent (SA) Configuration	115
4.4.2	PCH-IO Configuration	119
4.5	Security	124
4.6	Boot	127
4.7	Save & Exit	128
Appendix	WDT & GPIO	129
	WDT Sample Code	130
	GPIO Sample Code	131

Prefaces

Revision

Revision	Description	Date
1.0	Manual Released	2021/01/10

Disclaimer

All specifications and information in this User's Manual are believed to be accurate and up to date. C&T Solution Inc. does not guarantee that the contents herein are complete, true, accurate or non-misleading. The information in this document is subject to change without notice and does not represent a commitment on the part of C&T Solution Inc.

C&T Solution Inc. disclaims all warranties, express or implied, including, without limitation, those of merchantability, fitness for a particular purpose with respect to contents of this User's Manual. Users must take full responsibility for the application of the product.

Copyright Notice

All rights reserved. No part of this manual may be reproduced or transmitted in any form or by any means, electronic or mechanical, including photocopying, recording, or information storage and retrieval systems, without the prior written permission of C&T Solution Inc. Copyright © C&T Solution Inc.

Trademarks Acknowledgment

Intel®, Celeron® and Pentium® are trademarks of Intel Corporation.

Windows® is registered trademark of Microsoft Corporation.

AMI is trademark of American Megatrend Inc.

IBM, XT, AT, PS/2 and Personal System/2 are trademarks of International Business Machines Corporation

All other products and trademarks mentioned in this manual are trademarks of their respective owners.

Environmental Protection Announcement

Do not dispose this electronic device into the trash while discarding. Please recycle to minimize pollution and ensure environment protection.

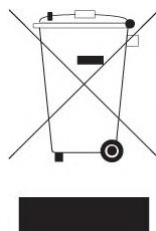

Safety Precautions

Before installing and using the equipment, please read the following precautions:

- Put this equipment on a reliable surface during installation. Dropping it or letting it fall could cause damage.
- The power outlet shall be installed near the equipment and shall be easily accessible.
- Turn off the system power and disconnect the power cord from its source before making any installation. Be sure both the system and the external devices are turned OFF. Sudden surge
- of power could ruin sensitive components. Make sure the equipment is properly grounded.
- When the power is connected, never open the equipment. The equipment should be opened only by qualified service personnel.
- Make sure the voltage of the power source is correct before connecting the equipment to the power outlet.
- Disconnect this equipment from the power before cleaning. Use a damp cloth. Do not use liquid or spray detergents for cleaning.
- Avoid the dusty, humidity and temperature extremes.
- Do not place heavy objects on the equipment.
- If the equipment is not used for long time, disconnect it from the power to avoid being damaged by transient over-voltage.
- The storage temperature shall be above -30°C and below 85°C .
- The computer is provided with a battery-powered real-time clock circuit. There is a danger of explosion if incorrectly replaced. Replace only with the same or equivalent type recommended by the manufacturer.
- If one of the following situation arises, get the equipment checked by service personnel:
 - The power cord or plug is damaged.
 - Liquid has penetrated into the equipment.
 - The equipment has been exposed to moisture.
 - The equipment does not work well or it cannot work according the user's manual.
 - The equipment has been dropped and damaged.
 - The equipment has obvious signs of breakage.

Technical Support and Assistance

1. Visit the C&T Solution Inc website at <https://www.candtsolution.com> where you can find the latest information about the product.
2. Contact your distributor, our technical support team or sales representative for technical support if you need additional assistance. Please have following information ready before you call:
 - Model name and serial number
 - Description of your peripheral attachments
 - Description of your software (operating system, version, application software, etc.)
 - A complete description of the problem
 - The exact wording of any error messages

Conventions Used in this Manual

**WARNING**

This indication alerts operators to an operation that, if not strictly observed, may result in severe injury.

**CAUTION**

This indication alerts operators to an operation that, if not strictly observed, may result in safety hazards to personnel or damage to equipment.

**NOTE**

This indication provides additional information to complete a task easily.

Package Contents

Before installation, please ensure all the items listed in the following table are included in the package.

Item	Description	Q'ty
1	VCO-6131-4M2 Series Fanless Embedded System	1
2	Utility DVD Driver	1
3	Wall Mount Kit	1
4	Accessory Kit	1

Ordering Information

Model No.	Product Description
VCO-6131E-4M2	Superior AI Edge Computing System with LGA-1151 socket for Intel® CFL-R S Processor

Optional Accessories

Model No.	Product Description
1-E09A22801	Adapter AC/DC 24V/11.67A 280W with 3pin Terminal Block Plug 5.0mm Pitch
1-E09A22102	Adapter AC/DC 24V 9.2A 220W with 3-pin Terminal Block Plug 5.0mm Pitch
SFICBL022	Power Cord, 3-pin US Type, 180cm
1-TPCD00002	Power Cord, European Type, 180cm
1-TPCD00001	Power Cord, 3-pin UK Type, 180cm

Chapter 1

Product Introductions

1.1 Overview

The GPU series adopts 9th Gen. Intel® Core™ i7-9700E (4.4GHz, 8 Cores) / i5-9700E (4.2GHz, 6 Cores) / i3-9100E (3.7GHz, 4 Core) / i7-9700TE (3.8GHz, 8 Cores) / i5-9500TE (3.6GHz, 6 Cores) / i3-9100TE (3.2GHz, 4 Cores) or 8th Gen. Intel® Core™ i7-8700T (4.0GHz, 6 Cores) / i5-8500T (3.5GHz, 6 Cores) / i3-8100T (3.1GHz, 4 Cores) or Pentium® G5400T (3.1GHz, Dual Core) / Celeron® G4900T (2.9GHz, Dual Core) Desktop processor (LGA 1151) which promises breakthrough performance and power efficiency over previous micro-architectures for high performance graphics, dramatic high-resolution video playback, outstanding system performance and responsiveness, and stronger security. It is designed with customers in mind to deliver an excellent system performance, higher reliability and robustness in a compact construction.

C&T GPU Computing System is your great solution for Machine Vision, Embedded System, Traffic Vision, Telemedicine, Intelligent Control, Deep Learning, Artificial Intelligence, Voice Reorganization and any graphics performance driven Industry 4.0/IIoT applications.

VCO-6131E-4M2



1.1.1 Key Features

- Support 8th / 9th Gen. Intel® CFL-R S Processor (LGA 1151, 65W/35W TDP)
- Intel® Q370 chipset
- 2x DDR4 2400/2666Hz SODIMM. Max. up to 64GB
- Triple Independent Display by 1x DVI-I and 2x DisplayPort
- 2x Intel® GbE supporting Wake-on-LAN and PXE
- 2x Full-size mini PCIe (shared by 1x mSATA), 1x PCIe x16, and 4x M.2 (NVMe PCIe x2), 2x SIM socket
- 4x 2.5" SATA HDD bay with RAID 0, 1, 5, 10 support, 1x mSATA (shared by 1x Mini PCIe)
- 1x M.2 (M Key, PCIe x4, 2280, Support NVMe), 1x M.2 (E Key, PCIe x2, 2230, USB 2.0, Support CNVi)
- 6x RS-232/422/485 (4x internal)
- 4x USB 3.2 Gen 2 (10 Gbps), 5x USB 3.2 Gen 1 (5 Gbps, internal), 1x USB 3.0 header (internal)
- 8x DI + 8x DO with isolation
- 9 to 48VDC Wide Range Power Input Supporting AT/ATX Mode
- Wide Operating Temperature (-25°C to 60°C)
- TPM 2.0 Supported

1.2 Hardware Specification

System

Processor	Support 8 th /9 th Gen Intel® CFL-R S Processor (LGA 1151, 65W/35W TDP) Intel® Core™ i7-9700E, 8 Cores, 12MB cache, up to 4.4 GHz Intel® Core™ i5-9500E, 6 Cores, 9MB Cache, up to 4.2 GHz Intel® Core™ i3-9100E, 4 Core, 6MB Cache, 3.7 GHz Intel® Core™ i7-9700TE, 8 Cores, 12MB cache, up to 3.8 GHz Intel® Core™ i5-9500TE, 6 Cores, 9MB Cache, up to 3.6 GHz Intel® Core™ i3-9100TE, 4 Core, 6MB Cache, 3.2 GHz Intel® Core™ i7-8700T, 6 Cores, 12MB cache, up to 4.0 GHz Intel® Core™ i5-8500T, 6 Cores, 9MB Cache, up to 3.5 GHz Intel® Core™ i3-8100T, 4 Cores, 6MB Cache, 3.1 GHz Intel® Pentium® G5400T, 2 Cores, 4MB Cache, up to 3.1 GHz Intel® Celeron® G4900T, 2 Cores, 2MB Cache, up to 2.9 GHz
System Chipset	Intel® Q370 Express Chipset
LAN Chipset	GbE1: Intel I219LM (Support Wake-on-LAN and PXE) GbE2: Intel I210-AT (Support Wake-on-LAN and PXE)
Audio Code	Realtek ALC888S
System Memory	2x 260-Pin DDR4 2400/2666MHz SODIMM. Max. up to 64GB (Un-buffered and Non-ECC)
BIOS	AMI 256Mbit SPI BIOS
Watchdog	Software Programmable Supports 1~255 sec. System Reset
TPM	TPM 2.0
Display	
VGA	Yes (by optional split cable)
DVI	1x DVI-I, support resolution 1920 x 1200
Display Port	2x DisplayPort, support resolution 4096 x 2304
Multiple Display	Triple Display
Storage	
SSD/HDD	2x Internal 2.5" SATA HDD Bay (support H=9mm), 2x Removable 2.5" SATA HDD Bay (support H=9mm, hot-swappable) Support RAID 0, 1, 5, 10
mSATA	1x mSATA (Shared by 1x Mini PCI Express)
M.2	1x M.2 (M Key, PCIe x4, 2280, Support NVMe), 1x M.2 (E Key, PCIe x2, 2230, USB 2.0, Support CNVi)
NVMe	4x M.2 PCIe x2, 2280 (hot-swappable)
SIM Socket	2x Internal SIM socket
Expansion	
Mini PCI Express	2x Full-size Mini PCIe (1x shared by 1x mSATA) 1x PCIe x4 (1-lane)
PCI Express	1x PCIe x16 (8-lane) for GPU card 1x Slimline (8-lane) for 4x M.2 PCIe x2
Card Dimension	312mm(L) x 112mm(H)

I/O

COM	2x RS-232/422/485, 2x RS-232/422/485 (internal)
USB	4x USB 3.2 Gen 2 (10 Gbps), 5x USB 3.2 Gen 1 (5 Gbps, internal), 1x USB 3.0 header (internal)
LAN	2x RJ45
DIO	8 in / 8 out (Isolated)
Universal I/O Bracket	1x Universal I/O Bracket (By mini PCIe interface)
Others	4x WiFi Antenna Holes 1x Power Switch, 1x AT/ATX Switch, 1x Remote Power On/Off 1x PC/Car Mode Switch 1x Delay Time Switch 1x Removable CMOS Battery (internal)

Operating System

Windows	Windows 10
Linux	Linux kernel 5.X

Power

Power Mode	AT, ATX
Power Supply Voltage	9~48VDC
Power Ignition Sensing	Power Ignition Management
Power Connector	3-pin Terminal Block ; 4-pin Terminal Block
Power Adaptor	Optional AC/DC 24V, 220W/280W Optional AC/DC 24V, 280W for GPU
Power Protection	OVP (Over Voltage Protection); OCP (Over Current Protection) Reserve Protection

Environment

Operating Temp.	-25°C to 60°C (65W / 35W CPU)
Storage Temp.	-30°C to 85°C
Relative Humidity	10% to 95% (non-condensing)
Vibration	With SSD: 3 Grms, 5 - 500 Hz, 0.5 hr/axis With HDD: 1 Grms, 5 - 500 Hz, 0.5 hr/axis
Shock	With SSD: 20G, half sine, 11ms
Standards / Certification	CE, FCC Class A

Physical

Construction	Extruded Aluminum with Heavy Duty Metal
Dimension	157 (W) x 340 (D) x 240 (H) mm
Weight	9.5 kg
Mounting	Wall Mounting

1.3 System I/O

Front Panel

ATX power on/off switch

Press to power-on or power-off the system

USB 3.2 Gen 2 port (10 Gbps)

Used to connect USB device

COM port

COM1 & COM2, Support RS232/422/485 serial device

Antenna hole

Used to connect an antenna for optional Mini-PCIe WiFi module

LAN Port

Used to connect the system to a local area network

DC IN

Used to plug a DC power input with terminal block

DisplayPort

Used to connect a DisplayPort monitor

DVI-I port

Used to connect a DVI monitor or connect optional split cable for dual display mode

Digital I/O

Terminal Block The Digital I/O terminal block supports 4 digital input and 4 digital output\

Universal Bracket

2x Universal I/O Bracket (By mini PCIe interface)

M.2 Slot

Used to connect M.2 device for storage
4x M.2 PCIe x2, 2280 (hot-swappable)

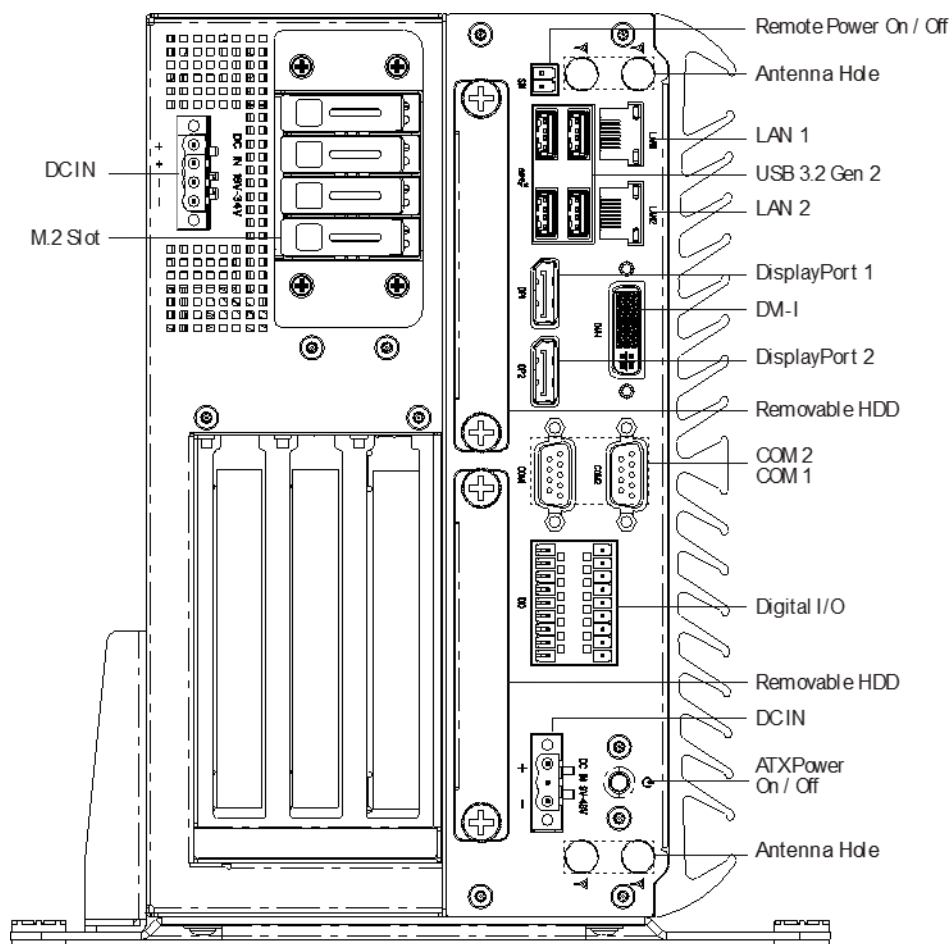

1.3 System I/O

Top Panel

Universal I/O Bracket

Used to customized I/O output

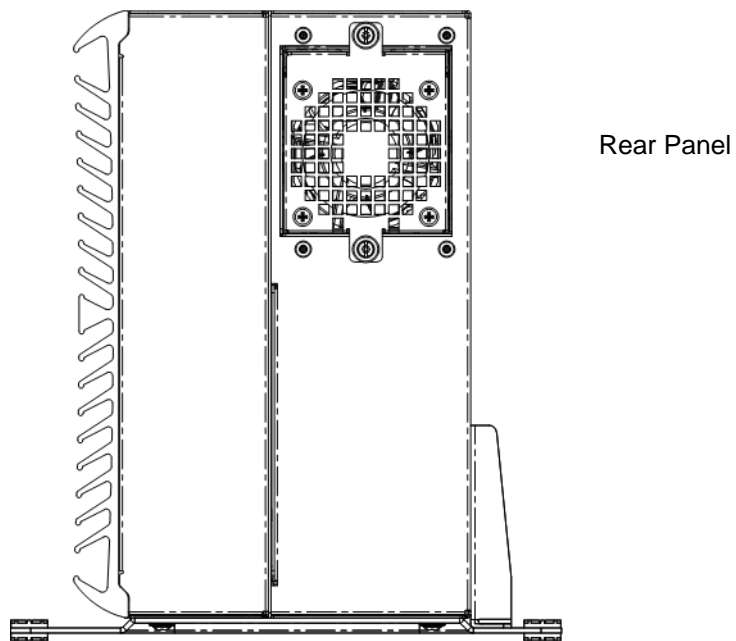
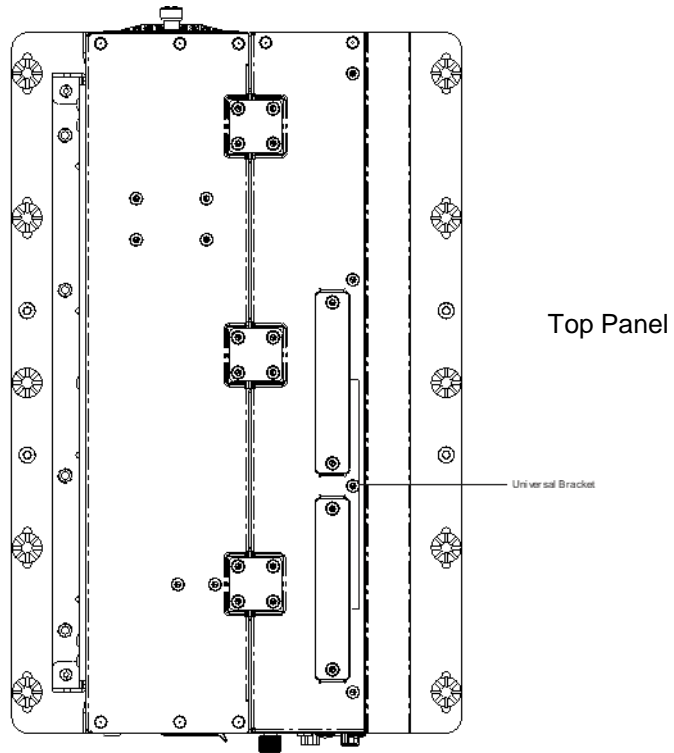

1.4 Mechanical Dimensions

Unit: mm

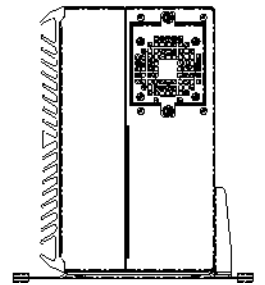
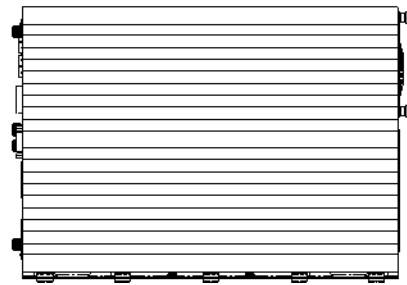
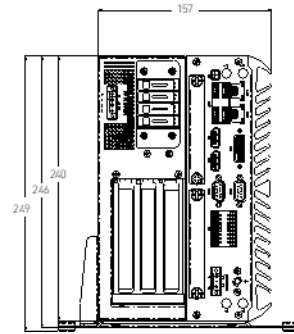
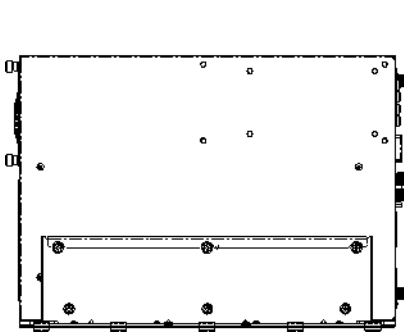
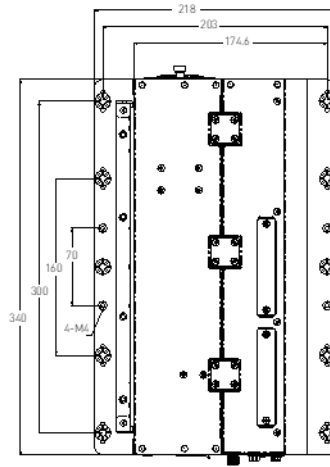

Chapter 2

Switches and Connectors

2.1 Switch and Connector Locations

2.1.1 Top View

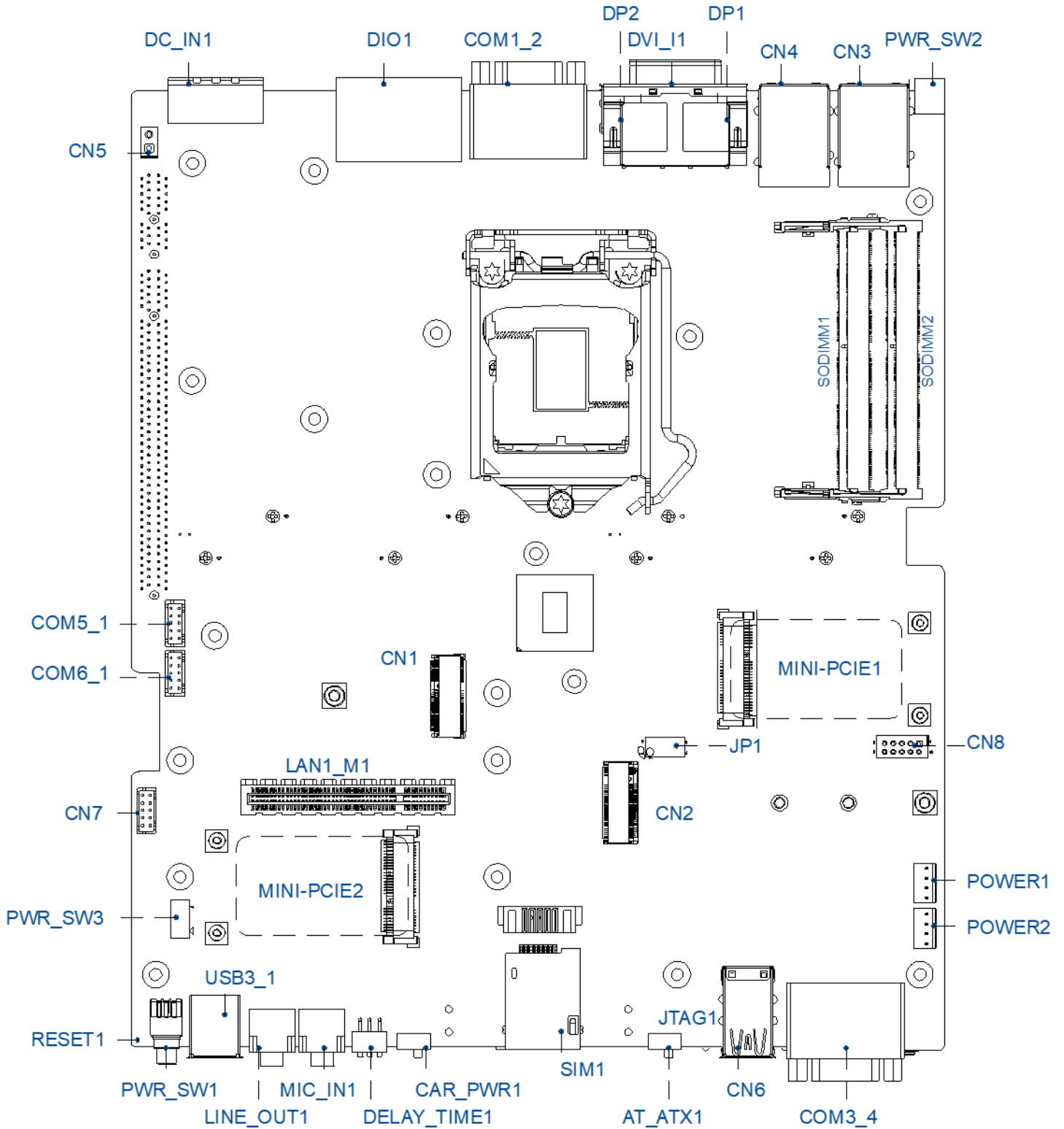

2.1.2 Bottom View

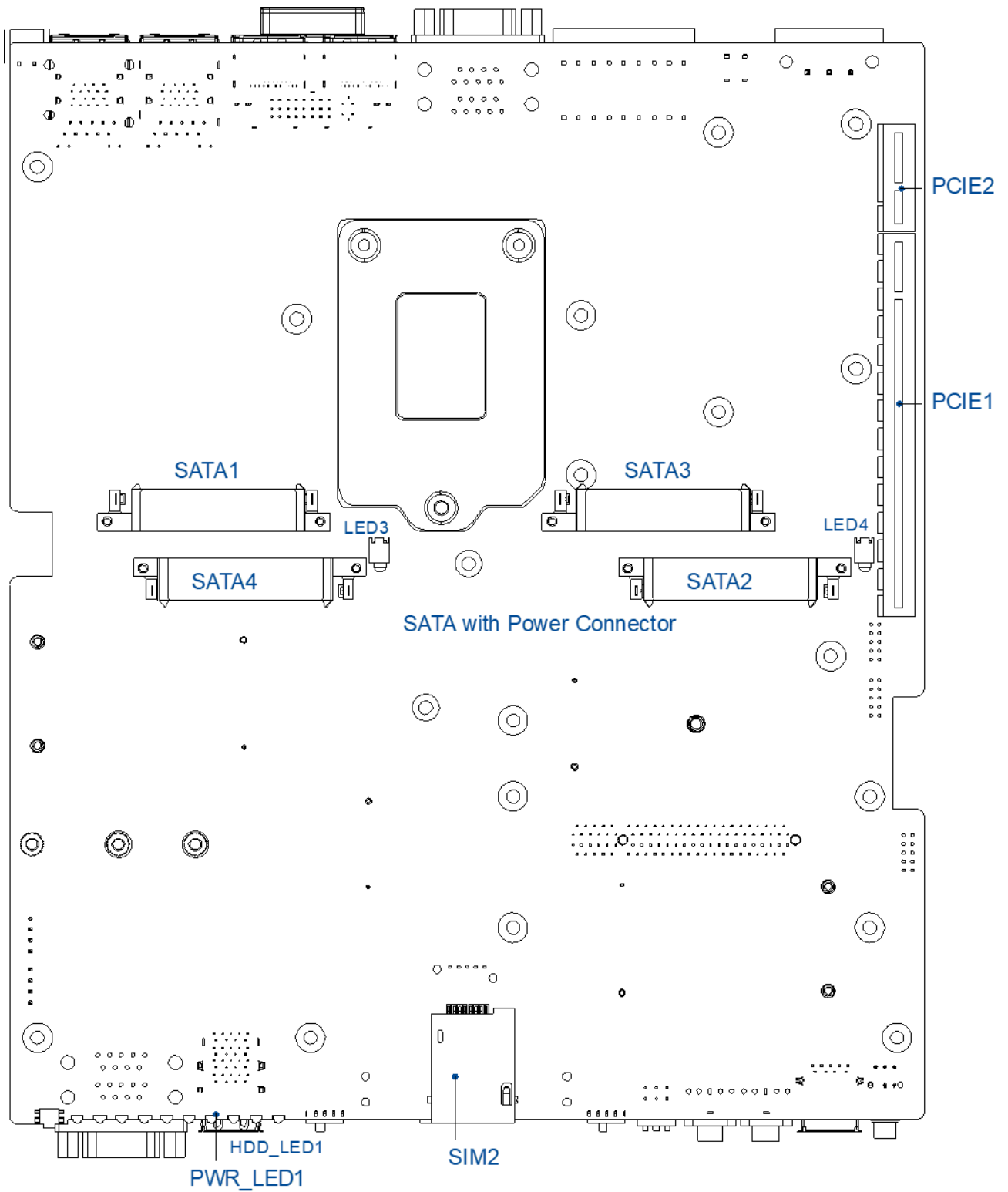

2.2 Connector / Switch Definition

List of Connector / Switch

Connector Location	Definition
AT_ATX1	AT / ATX Power Mode Switch
PWR_SW1	Power Switch
RESET1	Reset Switch
USB	USB 3.2 Gen 2 、 USB 3.2 Gen 1 、 USB2.0
SIM1, SIM2	SIM Card Socket
COM3_4, COM1_2	RS232 / RS422 / RS485 Connector
COM5_1, COM6_1	RS232 / RS422 / RS485 Connector
DC_IN1	3-pin DC 9~48V Power Input Connector
DVI_I1	DVI-I Connector
MIC_IN1	Mic-in Jack
DIO1	8DI / 8DO Connector
PWR_SW2, PWR_SW3	Remote Power Switch
CN1	M.2 E Key Socket
CN2	M.2 M Key Socket
MINIPCIE1, MINIPCIE2	Mini PCI-Express Socket
CN3, CN4	LAN and USB3.1 GEN 2 Ports
SATA1, SATA2, SATA3, SATA4	SATA with Power Connector
POWER1, POWER2	Power Connector
PCIE	PCI-Express X1 Slot, PCI-Express X8 Slot, PCI-Express X16 Slot
PWR_LED1	Power LED Status
HDD_LED1	HDD Access LED Status
WDT_LED1	Watchdog LED Status
GPIO_LED1	GPIO LED Status
CAR_PWR1	CAR mode / PC mode select
DELAY_TIME1	CAR mode delay time setting

2.3 I/O Interface Descriptions

2.3.1 LPC Debug Con

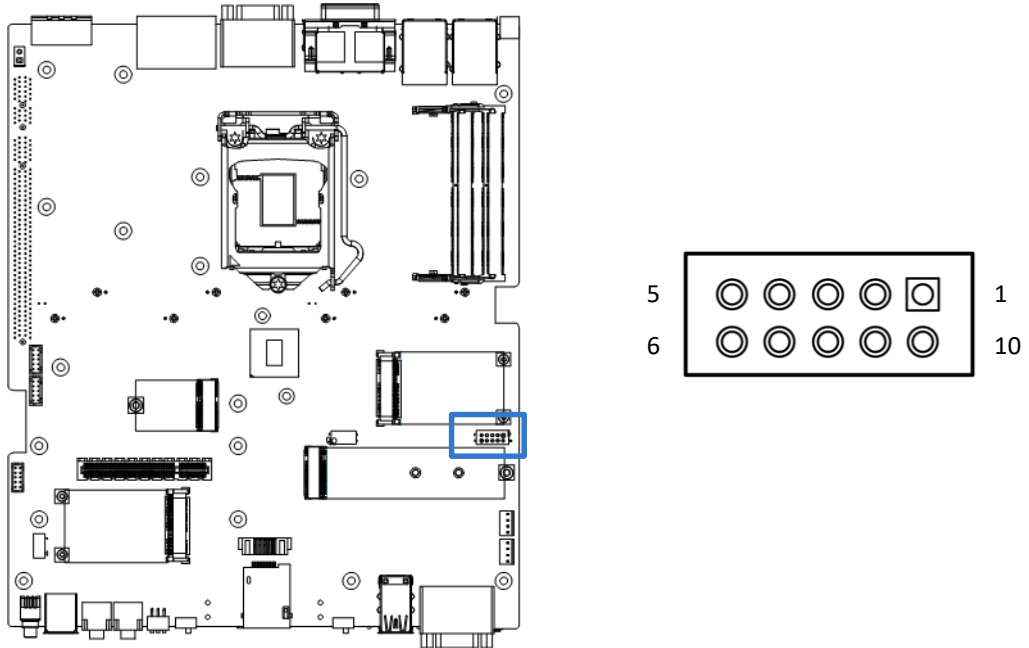

CN8

Pin	Signal	Pin	Signal
1	+3.3V	10	LPC_AD3
2	NC	9	LPC_AD2
3	Reset	8	LPC_AD1
4	LPC_FRAME-L	7	LPC_AD0
5	Clock	6	GND

2.3 I/O Interface Descriptions

2.3.2 Power Con

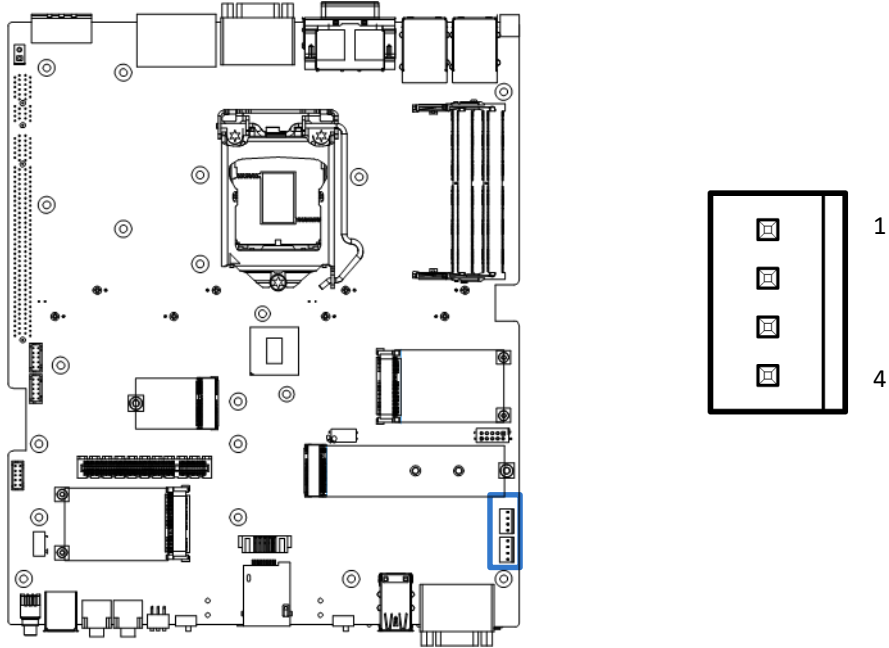

POWER1

Pin	Signal
1	+5V
2	GND
3	GND
4	+12V

2.3 I/O Interface Descriptions

2.3.3 DC IN/IGN IN (+9V ~ +48V)

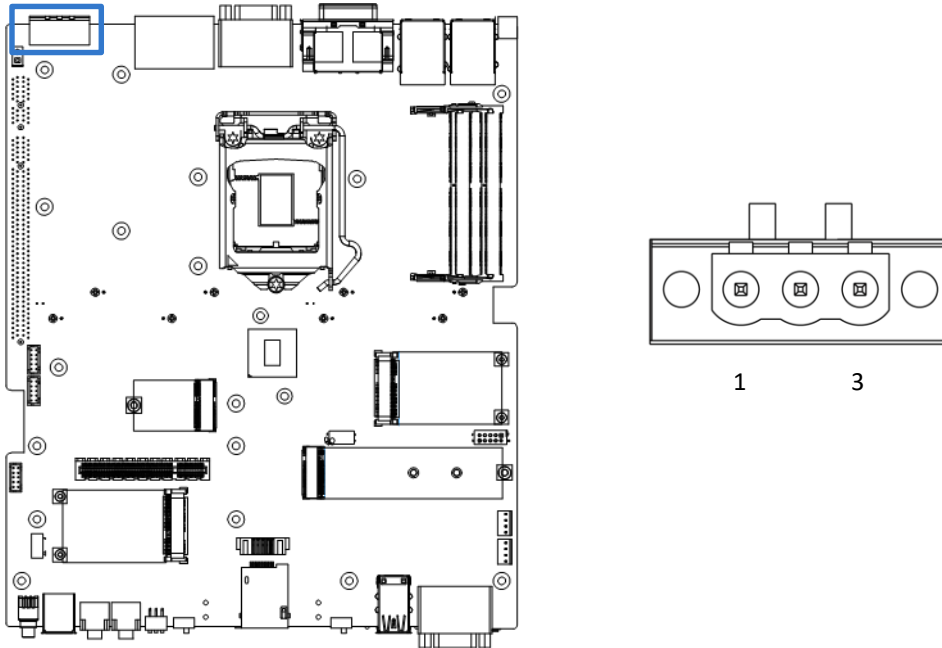

DC_IN1

Pin	Signal
1	+DC_IN
2	IGN_SENSE
3	GND

2.3 I/O Interface Descriptions

2.3.4 COM Con

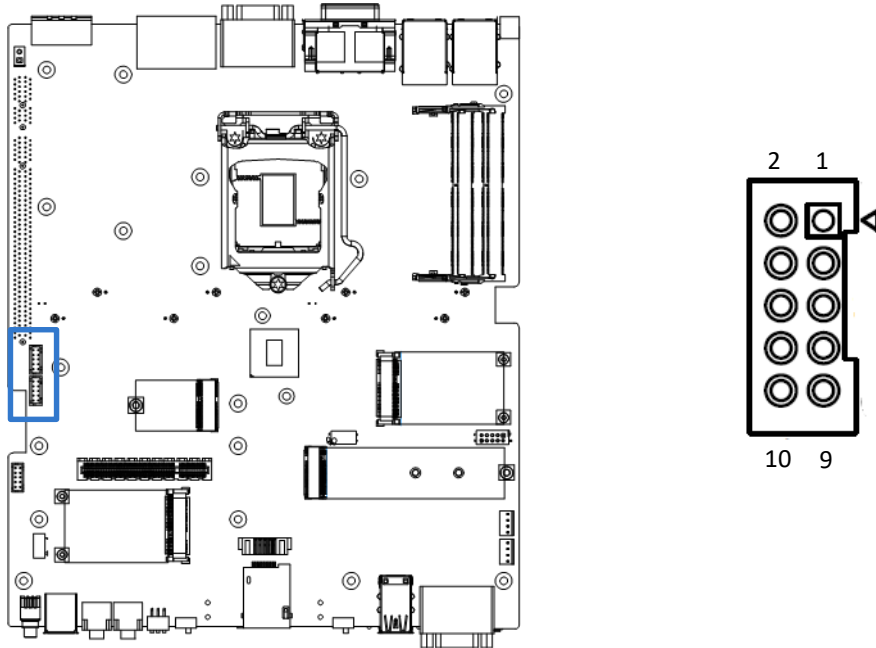

COM5_1 , COM6_1

Pin	Signal	Pin	Signal
1	DCD#	2	DSR#
3	RXD	4	RTS#
5	TXD	6	CTS#
7	DTR#	8	RI#
9	GND	10	NC

RS232 / RS422 / RS485 Connector 2x5 10-pin box header, 2.0mm pitch

Pin	RS232 Definition	RS422 / 485 Full Duplex Definition	RS485 Half Duplex Definition
1	DCD#	TX-	DATA-
2	DSR#		
3	RxD	TX+	DATA+
4	RTS#		
5	TxD	RX+	
6	CTS#		
7	DTR#	RX-	
8	RI#		
9	GND	GND	GND
10	NC	NC	NC

2.3 I/O Interface Descriptions

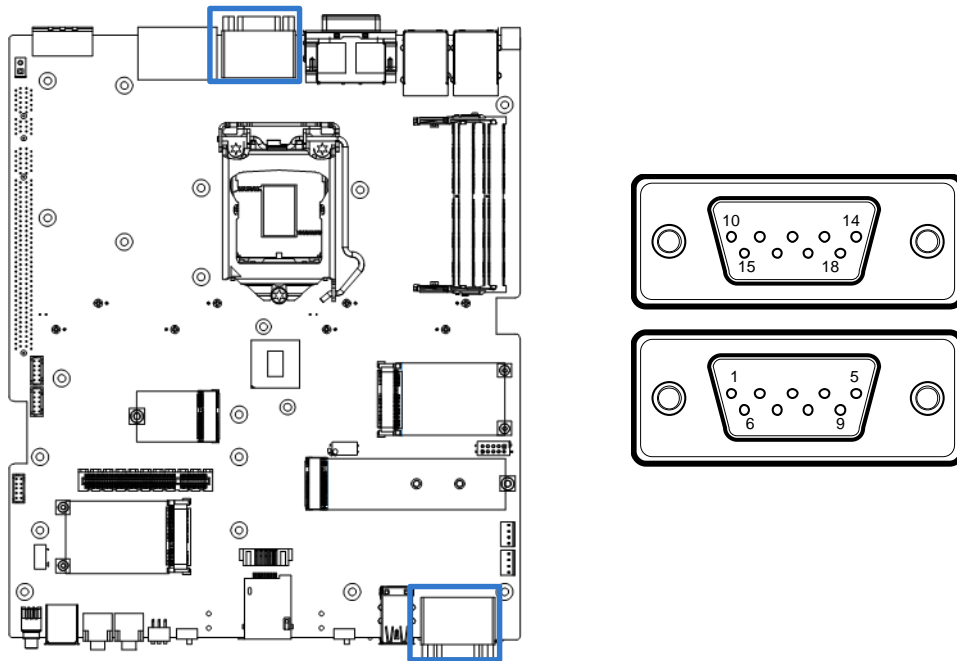

COM1_2 , COM3_4

RS232 / RS422 / RS485 Connector Type: 9-pin D-Sub

Pin	RS232 Definition	RS422 / 485 Full Duplex Definition	RS485 Half Duplex Definition
1(10)	DCD#	TX-	DATA-
2(11)	RxD	TX+	DATA+
3(12)	TxD	RX+	
4(13)	DTR#	RX-	
5(14)	GND	GND	GND
6(15)	DSR#		
7(16)	RTS#		
8(17)	CTS#		
9(18)	RI#		

2.3 I/O Interface Descriptions

2.3.5 SF100 SPI Con

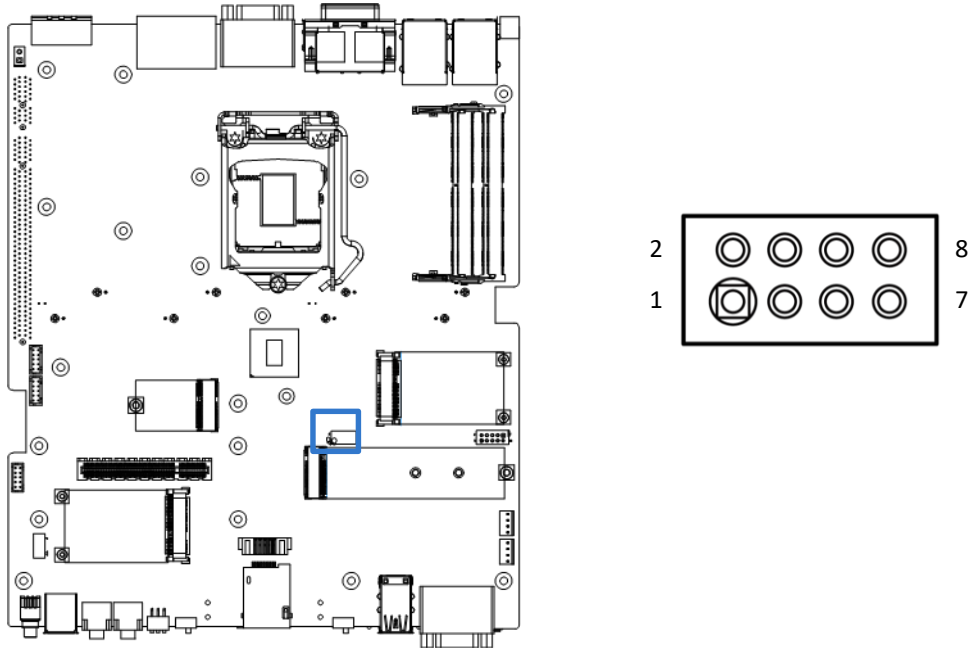

JP1

Pin	Signal	Pin	Signal
1	Power (3V)	2	GND
3	CS#	4	CLK
5	MISO	6	MOSI
7	NC	8	SPI_GATE#

2.3 I/O Interface Descriptions

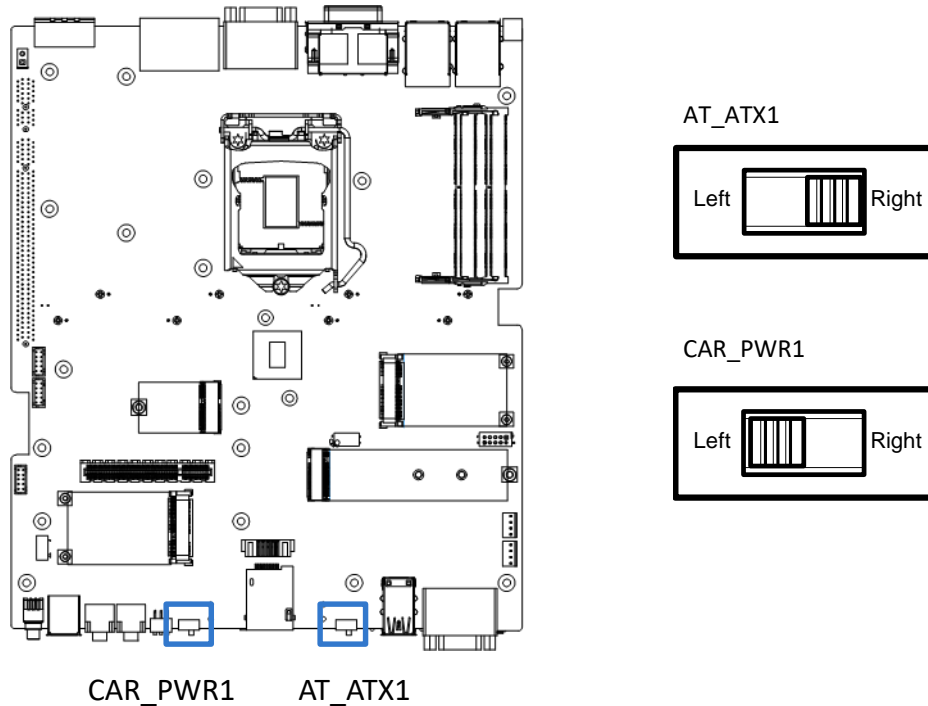

AT_ATX1: AT / ATX Power Mode Switch

Switch	Definition
1-2 (Left)	ATX Power Mode (Default)
2-3 (Right)	AT Power Mode

CAR_PWR1: PC / Car Mode Switch

Switch	Definition
1-2 (Left)	Power Mode (Default)
2-3 (Right)	Power Ignition Mode

2.3 I/O Interface Descriptions

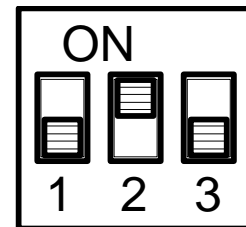
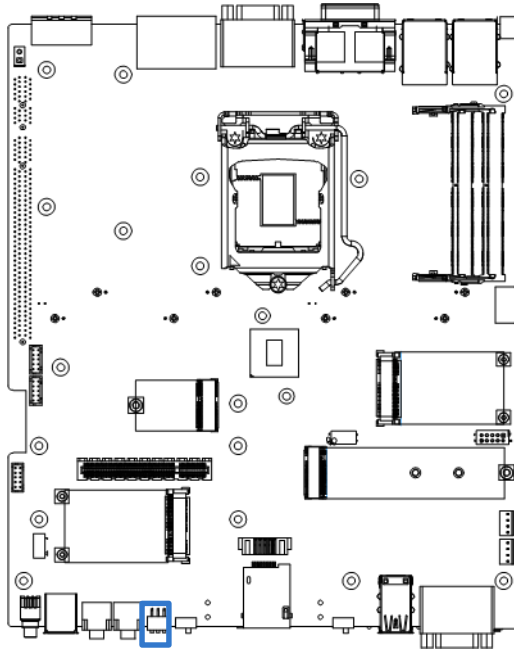

DELAY_TIME1

Power off delay time setup Switch

Switch 1 / 2 / 3	Definition
ON / ON / ON	3 sec. (Default Shutdown Timer by O.S)
ON / ON / OFF	1 min.
ON / OFF / ON	5 min.
ON / OFF / OFF	10 min.
OFF / ON / ON	30 min.
OFF / ON / OFF	1 hour
OFF / OFF / ON	2 hour

2.3 I/O Interface Descriptions

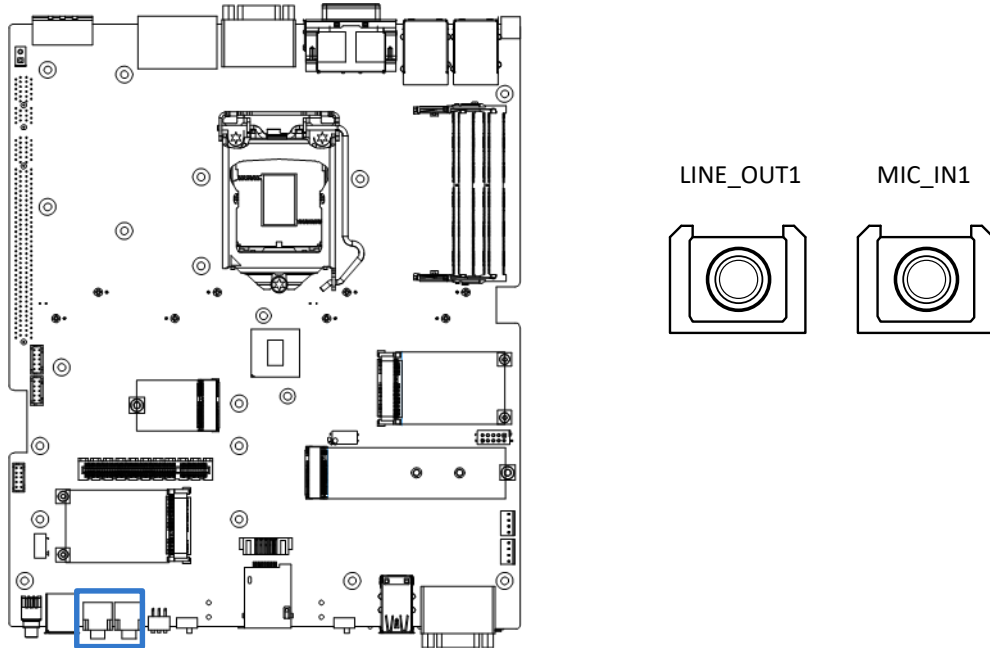

LINE_OUT1 :

Line-out Jack (Green) Connector Type: 5-pin Phone Jack

Pin	Definition
1	GND
2	OUT_R
3	GND
4	GND
5	OUT_L

MIC_IN1 :

Microphone Jack (Pink) Connector Type: 5-pin Phone Jack

Pin	Definition
1	GND
2	MIC_R
3	GND
4	GND
5	MIC_L

2.3 I/O Interface Descriptions

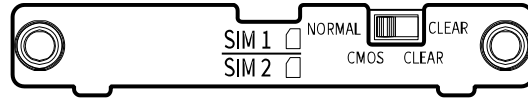

CLR_CMOS1: Clear BIOS Switch

Switch	Definition
1-2 (Left)	Normal Status (Default)
2-3 (Right)	Clear BIOS

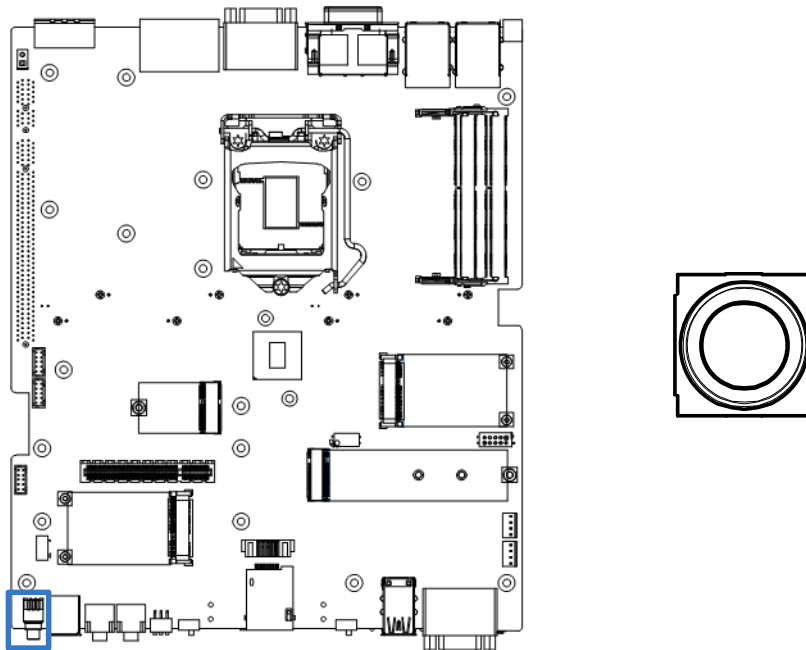

PWR_SW1: Power Button

Pin	Definition	Pin	Definition
1	NC	4	GND
2	Power Button	5	NC
3	NC	6	GND

2.3 I/O Interface Descriptions

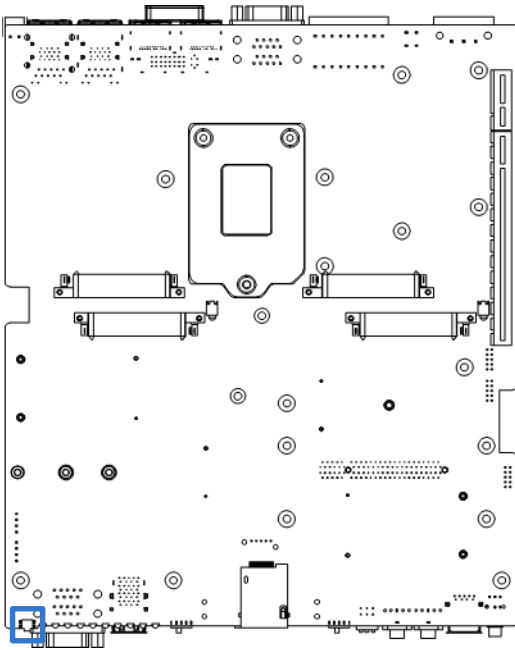

RESET1 : Reset Button

Pin	Definition
1,2	RESET
3,4	GND

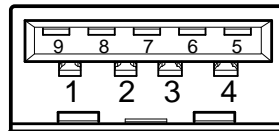
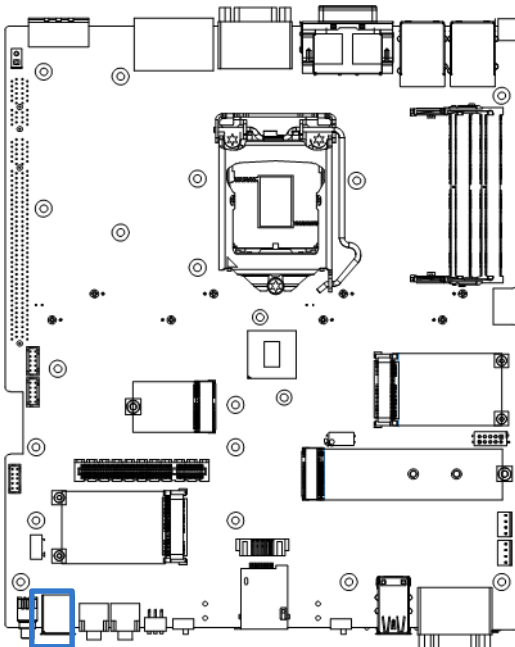

USB3_1 : USB3.1 Connector, Type A

Pin	Definition	Pin	Definition
1	+5V	6	USB3_RX+
2	USB2_D-	7	GND
3	USB2_D+	8	USB3_TX-
4	GND	9	USB3_TX+
5	USB3_RX-		

2.3 I/O Interface Descriptions

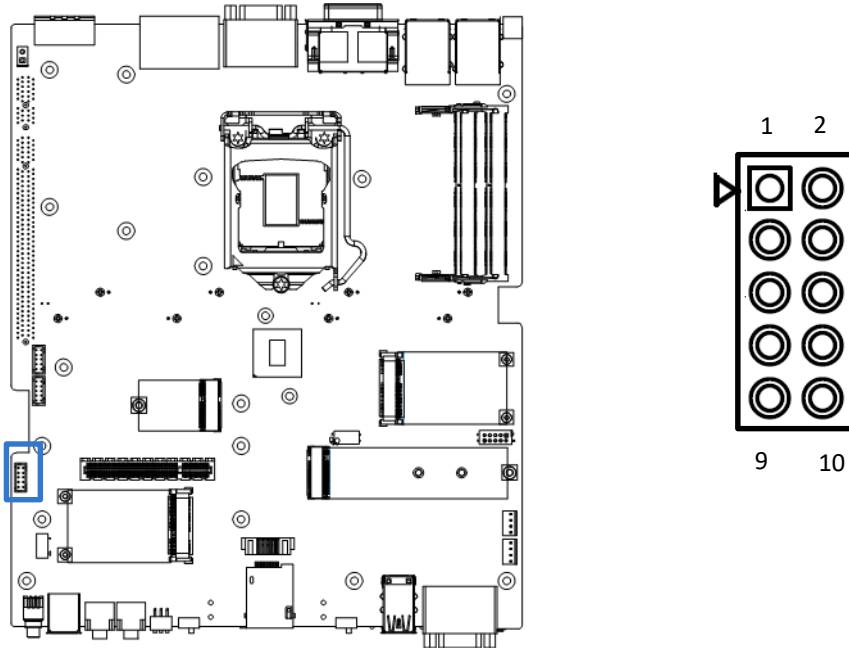

CN7 : USB3.0 Connector 2x5 9-pin header, 2.0mm pitch

Pin	Definition	Pin	Definition
1	+5V	2	USB3_TX-
3	USB2_D-	4	USB3_TX+
5	USB2_D+	6	GND
7	GND	8	USB3_RX-
		10	USB3_RX+

2.3 I/O Interface Descriptions

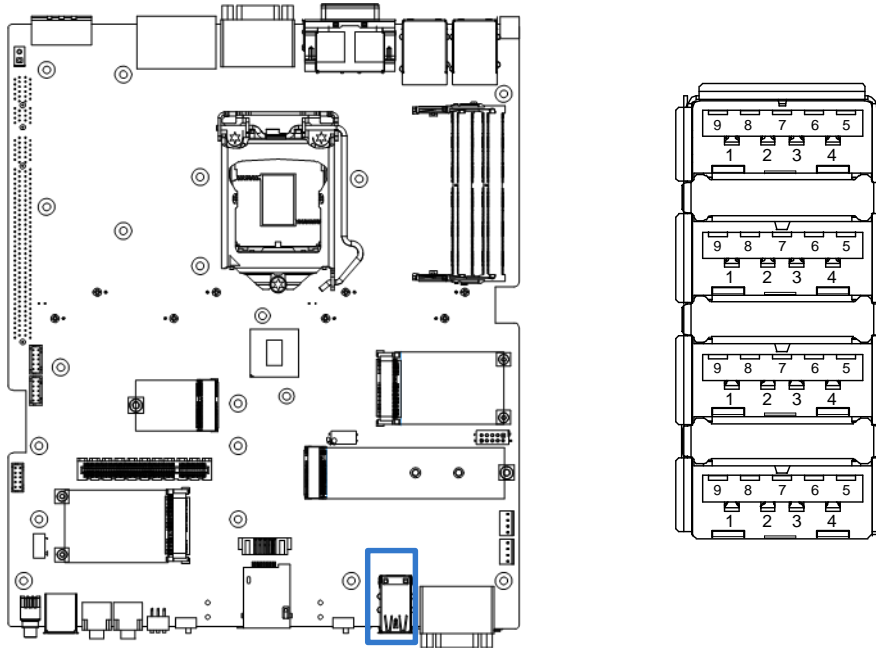

CN6 : USB3.1 Connector, Type A x 4

Pin	Definition	Pin	Definition
1	+5V	6	USB3_RX+
2	USB2_D-	7	GND
3	USB2_D+	8	USB3_TX-
4	GND	9	USB3_TX+
5	USB3_RX-		

2.3 I/O Interface Descriptions

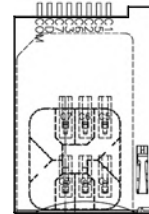
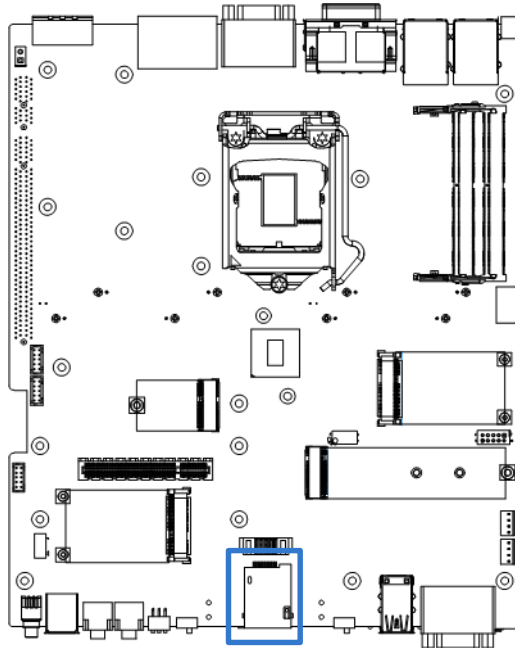

SIM1 :
Top side SIM Card Socket

SIM2 :
Bottom side SIM Card Socket

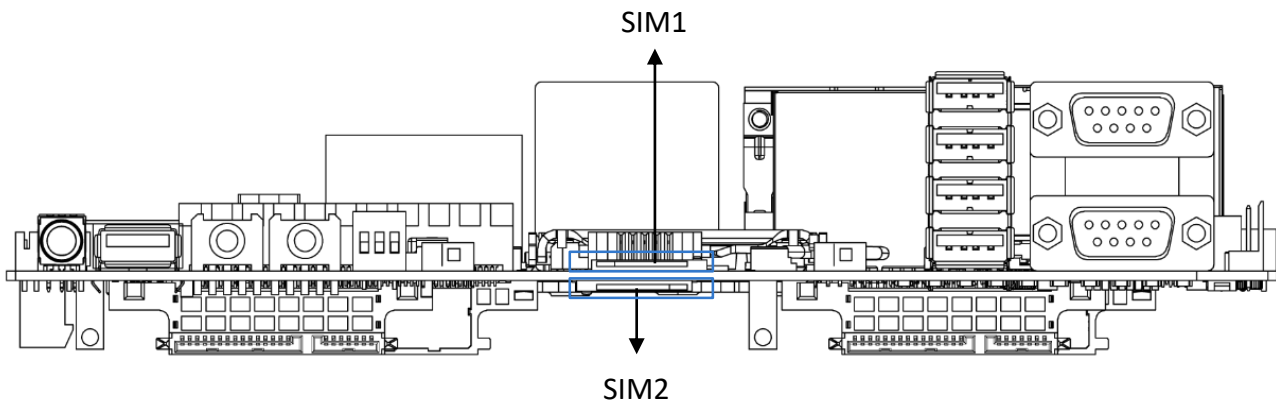

Pin	Definition	Pin	Definition
C1	UIM_PWR	C6	UIM_VPP
C2	UIM_RESET	C7	UIM_DATA
C3	UIM_CLK	CD	NC
C5	GND	COM	GND

2.3 I/O Interface Descriptions

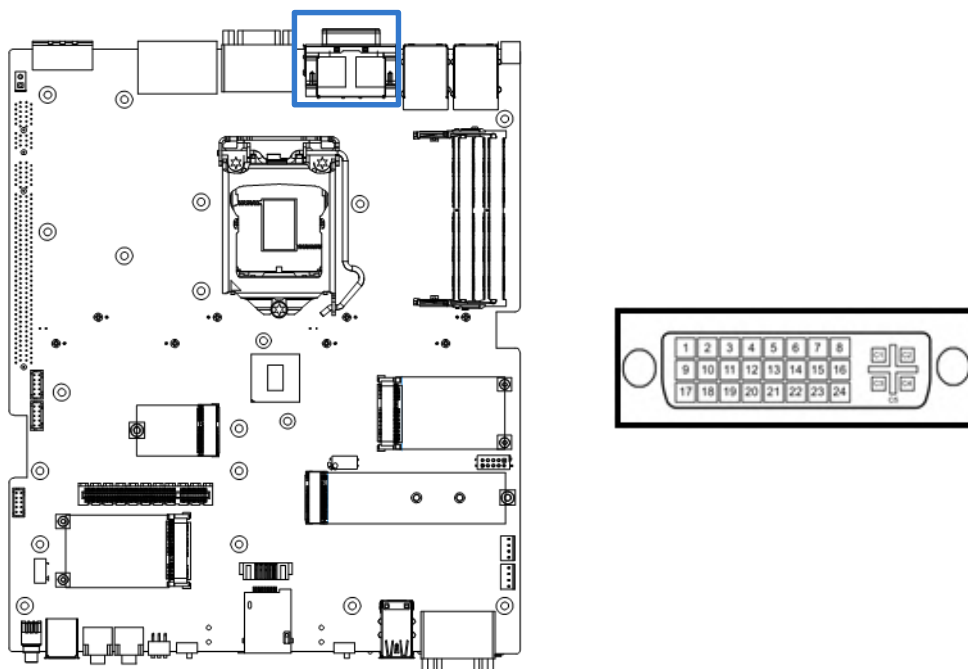

DVI_I1: DVI-I Connector

Pin	Definition	Pin	Definition
1	DVI_TX2-	16	DVI Hot Plug Detect
2	DVI_TX2+	17	DVI_TX0-
3	GND	18	DVI_TX0+
4	NC	19	GND
5	NC	20	VGA_DDC_CLOCK
6	DVI_DDC_CLOCK	21	VGA_DDC_DATA
7	DVI_DDC_DATA	22	GND
8	VGA_VSYNC	23	DVI_TXCLK+
9	DVI_TX1-	24	DVI_TXCLK-
10	DVI_TX1+	C1	VGA_RED
11	GND	C2	VGA_GREEN
12	NC	C3	VGA_BLUE
13	NC	C4	VGA_HSYNC
14	+5V	C5	GND
15	GND		

2.3 I/O Interface Descriptions

DP1 DP2 : Display Port Connector

Pin	Definition	Pin	Definition
1	DP_LANE0_P	11	GND
2	GND	12	DP_LANE3_N
3	DP_LANE0_N	13	GND
4	DP_LANE1_P	14	GND
5	GND	15	DP_AUX_P
6	DP_LANE1_N	16	GND
7	DP_LANE2_P	17	DP_AUX_N
8	GND	18	DP_HPD
9	DP_LANE2_N	19	GND
10	DP_LANE3_P	20	+3.3V

2.3 I/O Interface Descriptions

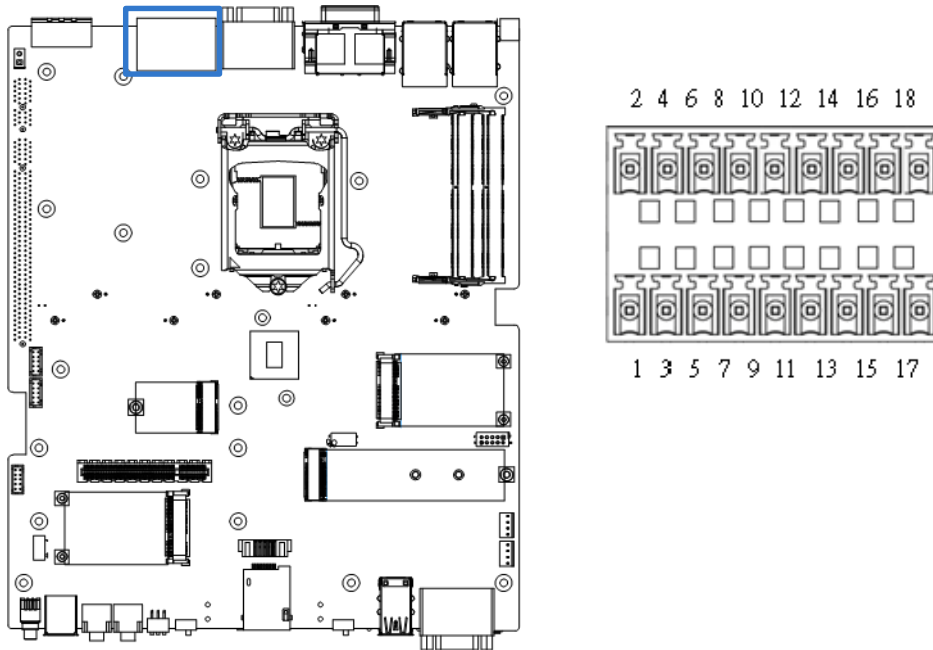

DIO : Digital Input / Output Connector Type: Terminal Block 2x9 18-pin, 3.5mm pitch

Pin	Definition	Pin	Definition
1	DIN1	2	DOUT1
3	DIN2	4	DOUT2
5	DIN3	6	DOUT3
7	DIN4	8	DOUT4
9	DIN5	10	DOUT5
11	DIN6	12	DOUT6
13	DIN7	14	DOUT7
15	DIN8	16	DOUT8
17	DC power input (+5V~+24V)	18	GND

2.3 I/O Interface Descriptions

Reference Input Circuit

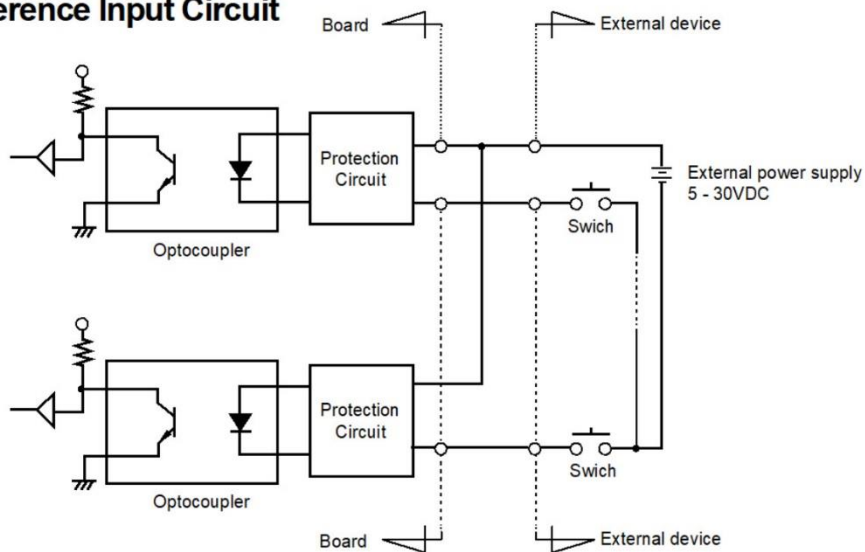

External Output Circuit

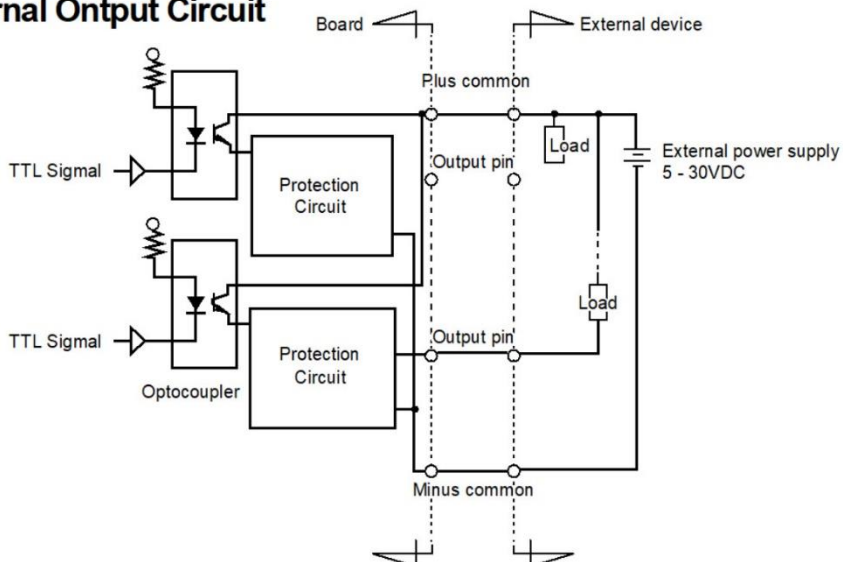

Digital Input Wurung

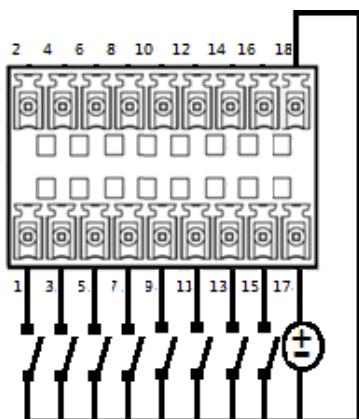

Digital Output Wurung

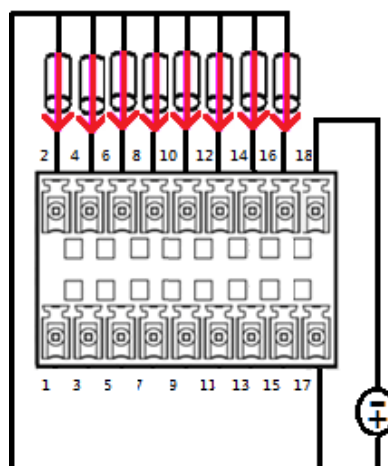

2.3 I/O Interface Descriptions

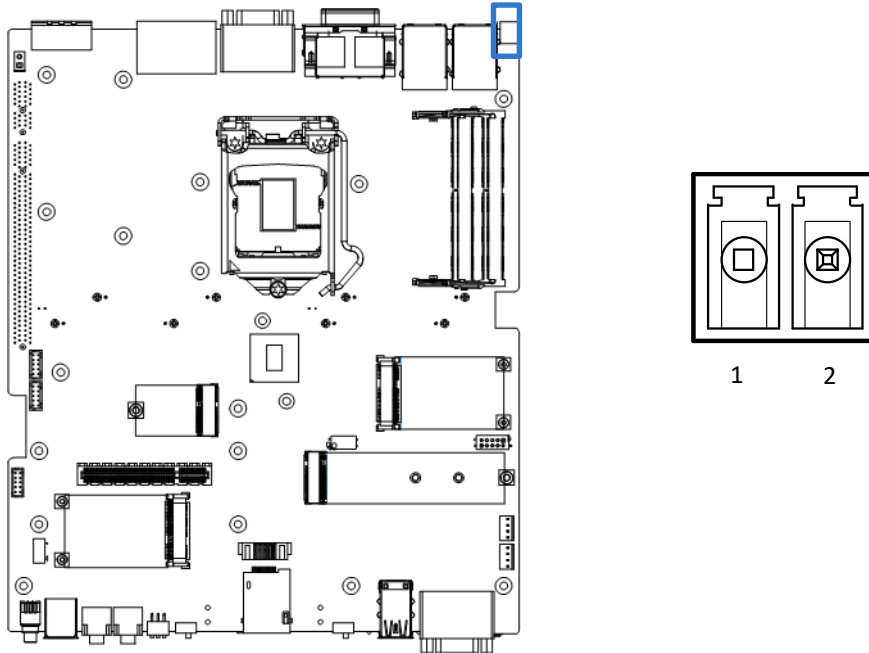

PWR_SW2 : Remote Power Switch Type: Terminal Block 1x2 2-pin, 3.5mm pitch

Pin	Definition
1	Power Button
2	GND

2.3 I/O Interface Descriptions

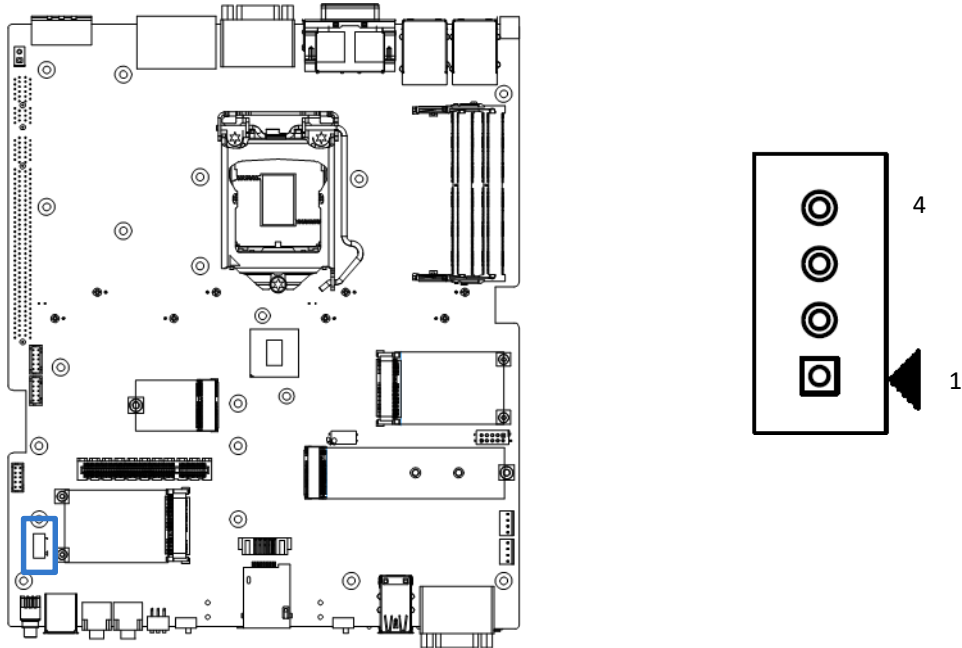

PWR_SW3 : Remote Power Switch 1x4 pin box header, 2.0mm pitch

Pin	Definition
1	Power Button
2	PWR_LED
3	HDD_LED
4	GND

2.3 I/O Interface Descriptions

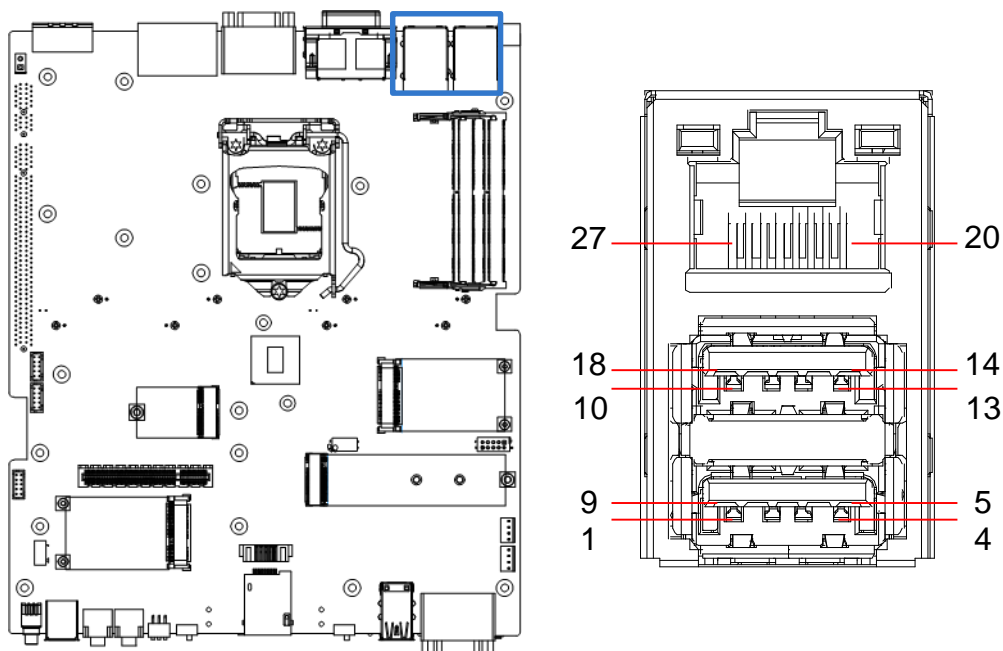

CN3 CN4 : LAN and USB3.1 GEN 2 Ports

Connector Type:RJ45 port with LEDs and dual USB3.1 ports

Pin	Definition	Pin	Definition	Pin	Definition
1	+5V	10	+5V	20	LAN1_MDI0P
2	USB2_D1-	11	USB2_D2-	21	LAN1_MDI0N
3	USB2_D1+	12	USB2_D2+	22	LAN1_MDI1P
4	GND	13	GND	23	LAN1_MDI2P
5	USB3_RX1-	14	USB3_RX2-	24	LAN1_MDI2N
6	USB3_RX1+	15	USB3_RX2+	25	LAN1_MDI1N
7	GND	16	GND	26	LAN1_MDI3P
8	USB3_TX1-	17	USB3_TX2-	27	LAN1_MDI3N
9	USB3_TX1+	18	USB3_TX2+		

2.3 I/O Interface Descriptions

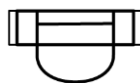
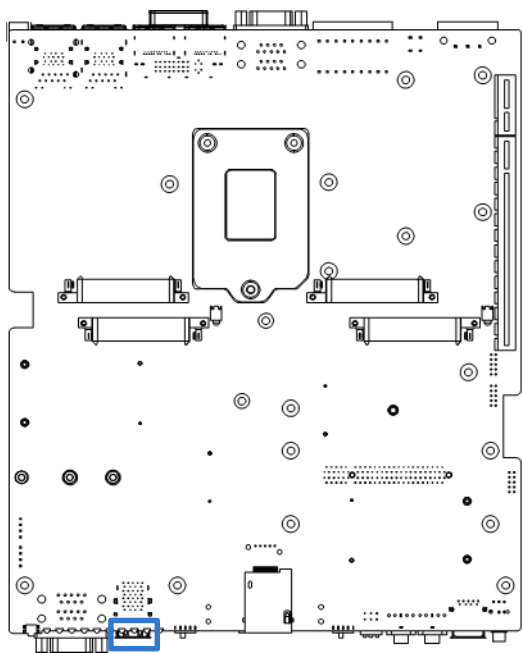

Act LED Status	Definition
Blinking Yellow	Data Activity
Off	No Activity



Link LED Status	Definition
Steady Orange	1Gbps Network Link
Steady Green	100Mbps Network Link
Off	10Mbps Network Link

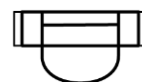
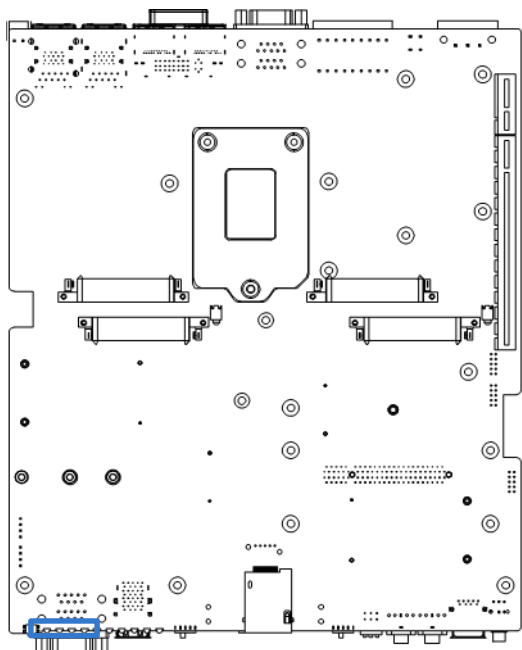

PWR_LED1: Power LED Status

Pin	Definition
1	POWER LED+
2	POWER LED-



HDD_LED1: HDD Access LED Status

Pin	Definition
1	HDD LED+
2	HDD LED-

2.3 I/O Interface Descriptions

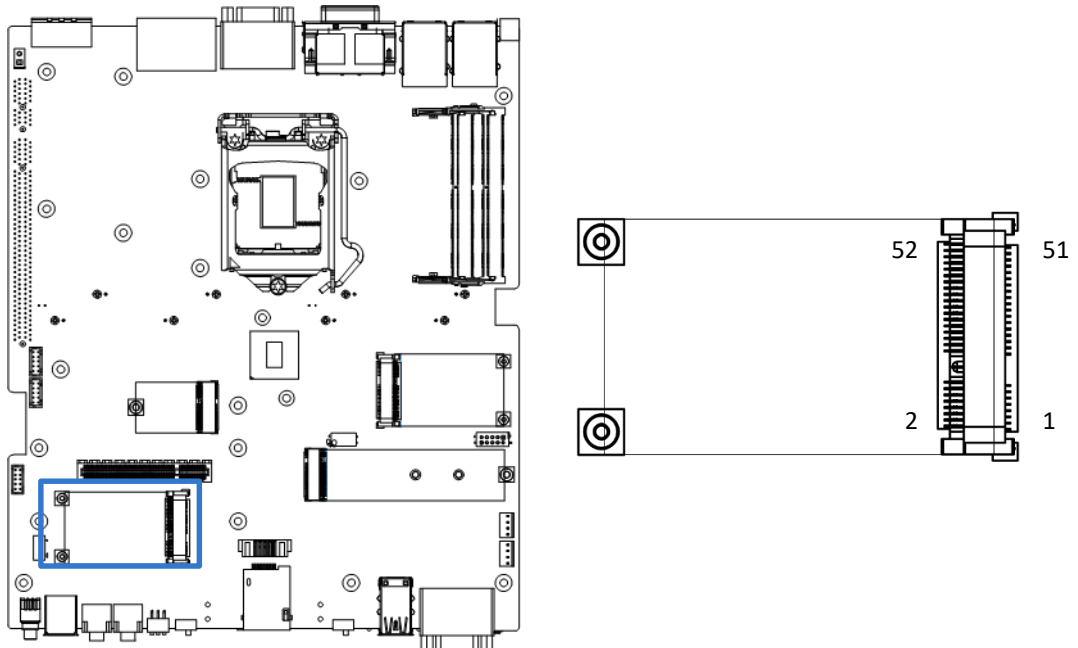

MINIPCIE2 : Mini PCI-Express Socket

Pin	Definition	Pin	Definition
1	WAKE#	2	+3.3V
3	NC	4	GND
5	NC	6	+1.5V
7	CLKREQ#	8	UIM_PWR
9	GND	10	UIM_DATA
11	REFCLK-	12	UIM_CLK
13	REFCLK+	14	UIM_RST
15	GND	16	UIM_VPP
17	NC	18	GND
19	NC	20	NC
21	GND	22	RESET#
23	RxN	24	+3.3VAUX
25	RxP	26	GND
27	GND	28	+1.5V
29	GND	30	SMB_CLK
31	TxN	32	SMB_DATA
33	TxP	34	GND
35	GND	36	USB2_D-
37	GND	38	USB2_D+
39	+3.3V	40	GND
41	+3.3V	42	NC
43	GND	44	NC
45	NC	46	NC
47	NC	48	+1.5V
49	NC	50	GND
51	NC	52	+3.3V

2.3 I/O Interface Descriptions

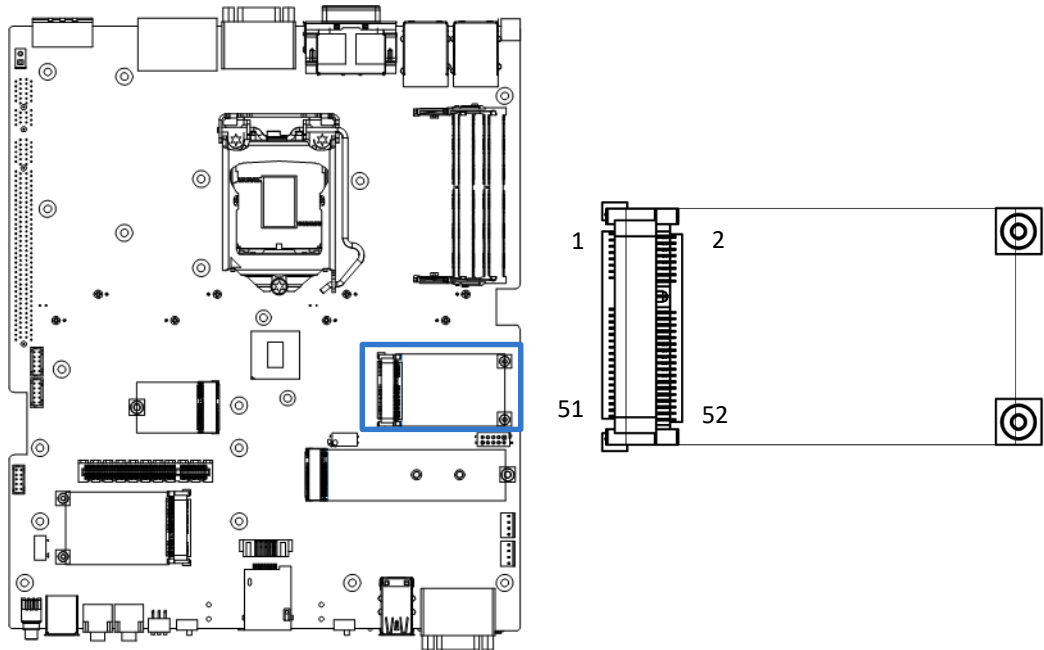

MINIPCIE1 : Mini PCI-Express / mSATA Socket

Pin	Definition	Pin	Definition
1	WAKE#	2	+3.3V
3	NC	4	GND
5	NC	6	+1.5V
7	CLKREQ#	8	UIM_PWR
9	GND	10	UIM_DATA
11	REFCLK-	12	UIM_CLK
13	REFCLK+	14	UIM_RST
15	GND	16	UIM_VPP
17	NC	18	GND
19	NC	20	NC
21	GND	22	RESET#
23	RxN	24	+3.3VAUX
25	RxP	26	GND
27	GND	28	+1.5V
29	GND	30	SMB_CLK
31	TxN	32	SMB_DATA
33	TxP	34	GND
35	GND	36	USB2_D-
37	GND	38	USB2_D+
39	+3.3V	40	GND
41	+3.3V	42	NC
43	GND	44	DEVS_LP
45	NC	46	NC
47	NC	48	+1.5V
49	NC	50	GND
51	PCIE_MSATA_SEL	52	+3.3V

2.3 I/O Interface Descriptions

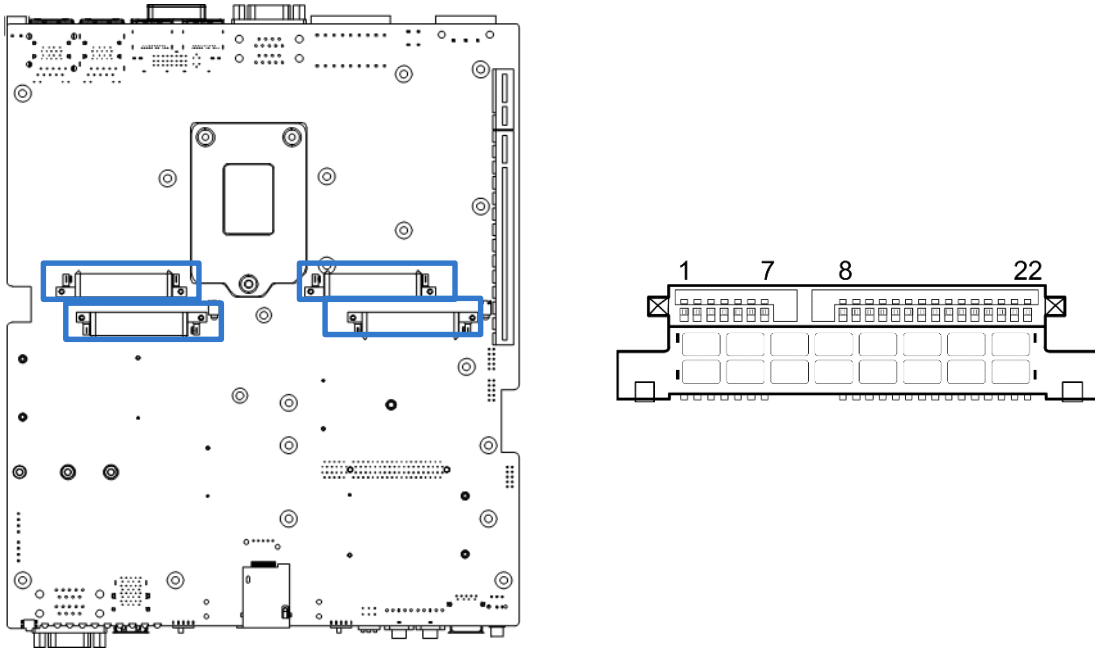

SATA with Power Connector

Pin	Definition	Pin	Definition
1	GND	12	GND
2	TxP	13	GND
3	TxN	14	+5V
4	GND	15	+5V
5	RxN	16	+5V
6	RxP	17	GND
7	GND	18	GND
8	NC	19	GND
9	NC	20	+12V
10	DEVSLP	21	+12V
11	GND	22	+12V

2.3 I/O Interface Descriptions

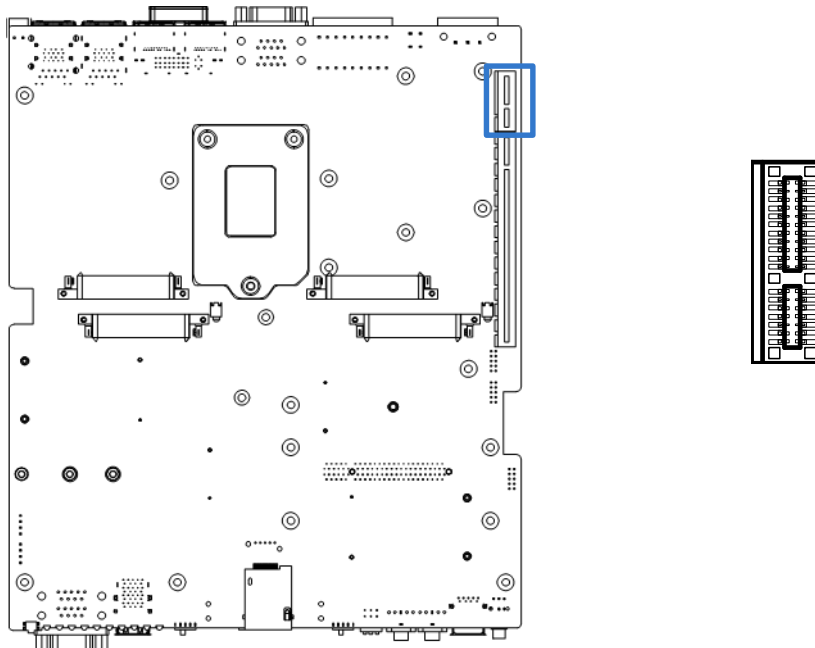

PCIE : PCI-Express x1 Slot

Pin	Definition	Pin	Definition
B1	+12V	A1	FAN_P4
B2	+12V	A2	+12V
B3	+12V	A3	+12V
B4	GND	A4	GND
B5	SMB_CLK	A5	NC
B6	SMB_DATA	A6	NC
B7	GND	A7	NC
B8	+3.3V	A8	NC
B9	NC	A9	+3.3V
B10	+3.3VAUX	A10	+3.3V
B11	WAKE#	A11	RESET#
B12	FAN_P3	A12	GND
B13	GND	A13	REFCLK+
B14	TxP0	A14	REFCLK-
B15	TxN0	A15	GND
B16	GND	A16	RxP0
B17	FAN_PER	A17	RxN0
B18	GND	A18	GND

2.3 I/O Interface Descriptions

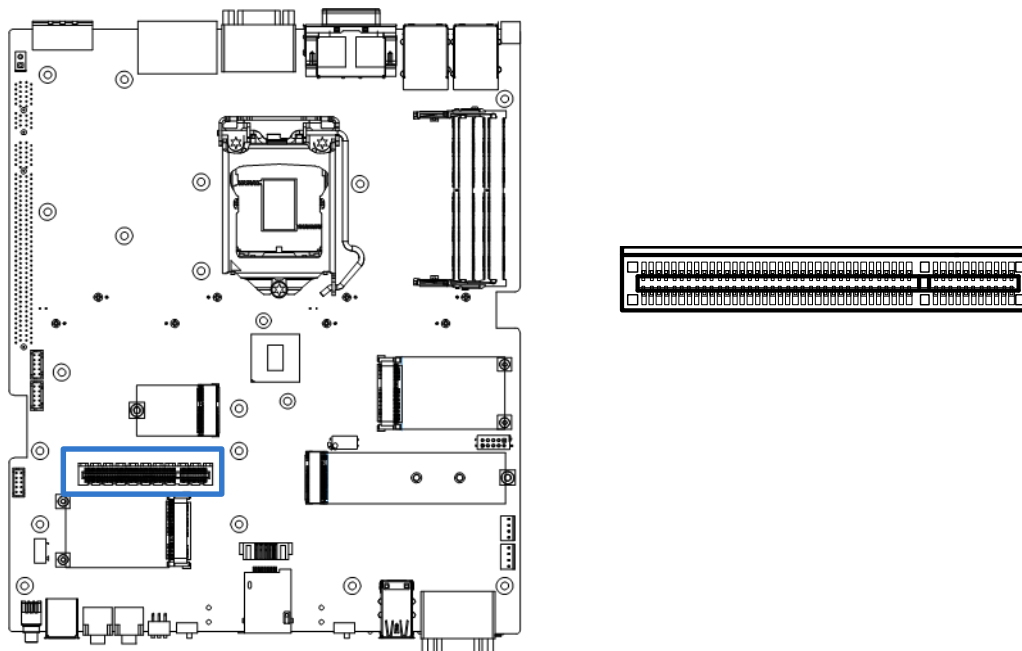

PCIE : PCI-Express x8 Slot

Pin	Definition	Pin	Definition
B1	+12V	A1	NC
B2	+12V	A2	+12V
B3	+12V	A3	+12V
B4	GND	A4	GND
B5	SMB_CLK	A5	NC
B6	SMB_DATA	A6	NC
B7	GND	A7	NC
B8	+3.3V	A8	NC
B9	NC	A9	+3.3V
B10	+3.3VAUX	A10	+3.3V
B11	WAKE#	A11	RESET#
B12	NC	A12	GND
B13	GND	A13	REFCLK+
B14	TxP0	A14	REFCLK-
B15	TxN0	A15	GND
B16	GND	A16	RxP0
B17	NC	A17	RxN0
B18	GND	A18	GND

2.3 I/O Interface Descriptions

PCIE : PCI-Express x8 Slot

Pin	Definition	Pin	Definition
B19	TxP1	A19	NC
B20	TxN1	A20	GND
B21	GND	A21	RxP1
B22	GND	A22	RxN1
B23	TxP2	A23	GND
B24	TxN2	A24	GND
B25	GND	A25	RxP2
B26	GND	A26	RxN2
B27	TxP3	A27	GND
B28	TxN3	A28	GND
B29	GND	A29	RxP3
B30	NC	A30	RxN3
B31	NC	A31	GND
B32	GND	A32	NC
B33	9_48VSB_IN	A33	9_48VSB_IN
B34	9_48VSB_IN	A34	9_48VSB_IN
B35	9_48VSB_IN	A35	9_48VSB_IN
B36	9_48VSB_IN	A36	9_48VSB_IN
B37	9_48VSB_IN	A37	9_48VSB_IN
B38	9_48VSB_IN	A38	9_48VSB_IN
B39	9_48VSB_IN	A39	9_48VSB_IN
B40	9_48VSB_IN	A40	9_48VSB_IN
B41	9_48VSB_IN	A41	9_48VSB_IN
B42	9_48VSB_IN	A42	9_48VSB_IN
B43	+3.3VAUX	A43	+5V
B44	+3.3VAUX	A44	+5V
B45	+3.3VAUX	A45	+1.5V
B46	+3.3VAUX	A46	+1.5V
B47	+1.0VAUX	A47	+1.0VAUX
B48	+1.0VAUX	A48	+1.0VAUX
B49	NC	A49	NC

2.3 I/O Interface Descriptions

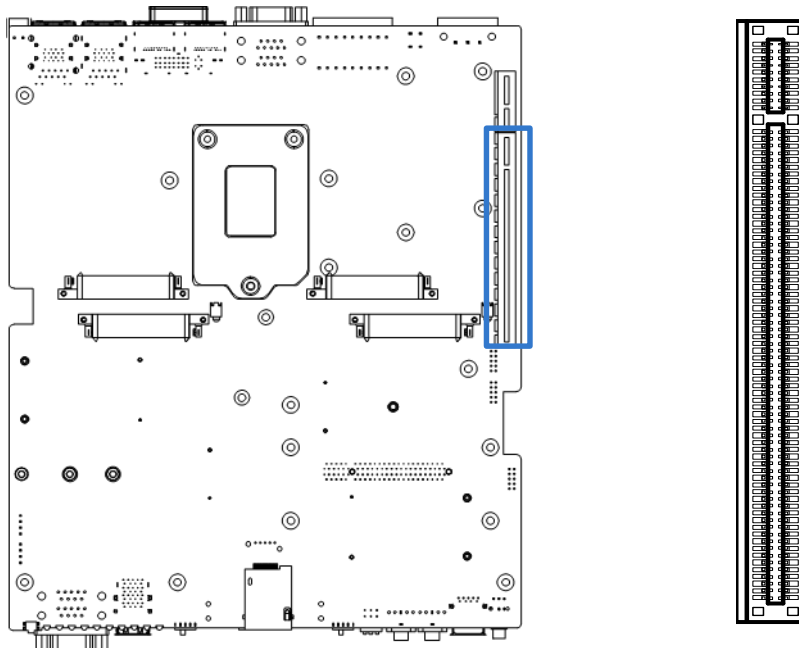

PCIE : PCI-Express x16 Slot

Pin	Definition	Pin	Definition
B1	+12V	A1	FAN_P4
B2	+12V	A2	+12V
B3	+12V	A3	+12V
B4	GND	A4	GND
B5	SMB_CLK	A5	NC
B6	SMB_DATA	A6	NC
B7	GND	A7	NC
B8	+3.3V	A8	NC
B9	NC	A9	+3.3V
B10	+3.3VAUX	A10	+3.3V
B11	WAKE#	A11	RESET#
B12	FAN_P3	A12	GND
B13	GND	A13	REFCLK+
B14	TxP0	A14	REFCLK-
B15	TxN0	A15	GND
B16	GND	A16	RxP0
B17	FAN_PWR	A17	RxN0
B18	GND	A18	GND

2.3 I/O Interface Descriptions

PCIE : PCI-Express x16 Slot

Pin	Definition	Pin	Definition
B19	TxP1	A19	NC
B20	TxN1	A20	GND
B21	GND	A21	RxP1
B22	GND	A22	RxN1
B23	TxP2	A23	GND
B24	TxN2	A24	GND
B25	GND	A25	RxP2
B26	GND	A26	RxN2
B27	TxP3	A27	GND
B28	TxN3	A28	GND
B29	GND	A29	RxP3
B30	NC	A30	RxN3
B31	S3	A31	GND
B32	GND	A32	CFG_5
B33	TxP4	A33	CFG_6
B34	TxN4	A34	GND
B35	GND	A35	RxP4
B36	GND	A36	RxN4
B37	TxP5	A37	GND
B38	TxN5	A38	GND
B39	GND	A39	RxP5
B40	GND	A40	RxN5
B41	TxP6	A41	GND
B42	TxN6	A42	GND
B43	GND	A43	RxP6
B44	GND	A44	RxN6
B45	TxP7	A45	GND
B46	TxN7	A46	GND
B47	GND	A47	RxP7
B48	NC	A48	RxN7
B49	GND	A49	GND
B50	TxP8	A50	NC

2.3 I/O Interface Descriptions

PCIE : PCI-Express x16 Slot

Pin	Definition	Pin	Definition
B51	TxN8	A51	GND
B52	GND	A52	RxP8
B53	GND	A53	RxN8
B54	TxP9	A54	GND
B55	TxN9	A55	GND
B56	GND	A56	RxP9
B57	GND	A57	RxN9
B58	TxP10	A58	GND
B59	TxN10	A59	GND
B60	GND	A60	RxP10
B61	GND	A61	RxN10
B62	TxP11	A62	GND
B63	TxN11	A63	GND
B64	GND	A64	RxP11
B65	GND	A65	RxN11
B66	TxP12	A66	GND
B67	TxN12	A67	GND
B68	GND	A68	RxP12
B69	GND	A69	RxN12
B70	TxP13	A70	GND
B71	TxN13	A71	GND
B72	GND	A72	RxP13
B73	GND	A73	RxN13
B74	TxP14	A74	GND
B75	TxN14	A75	GND
B76	GND	A76	RxP14
B77	GND	A77	RxN14
B78	TxP15	A78	GND
B79	TxN15	A79	GND
B80	GND	A80	RxP15
B81	NC	A81	RxN15
B82	NC	A82	GND

2.3 I/O Interface Descriptions

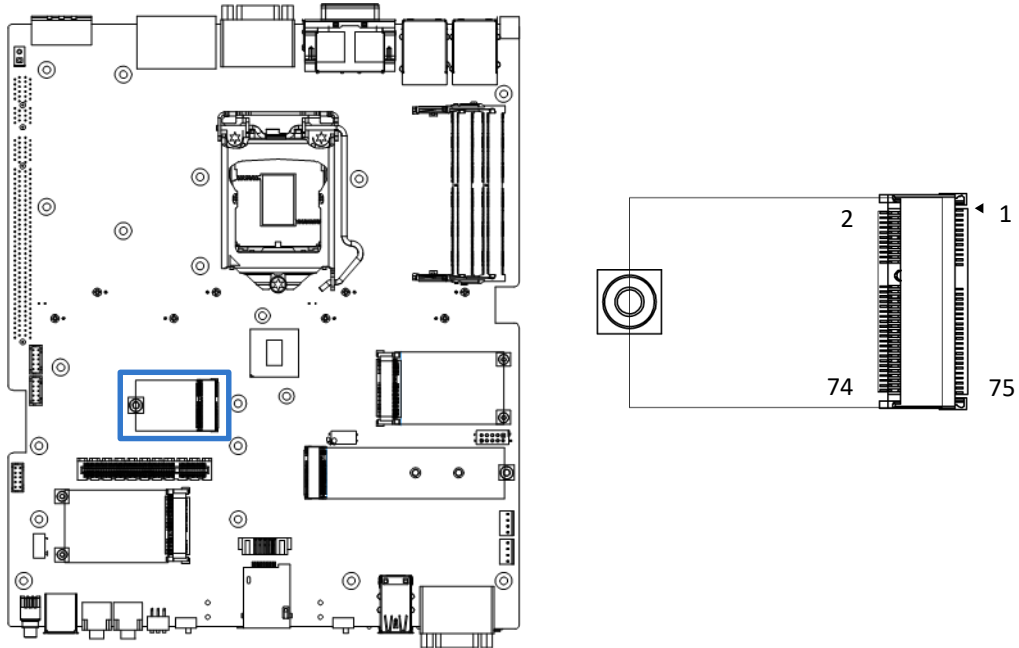

CN1 : M.2 E Key Socket

Pin	Definition	Pin	Definition
1	GND	2	+3.3VAUX
3	USB2_D+	4	+3.3VAUX
5	USB2_D-	6	LED1#
7	GND	8	NC
9	NC	10	NC
11	NC	12	NC
13	NC	14	NC
15	NC	16	LED2#
17	NC	18	GND
19	NC	20	NC
21	NC	22	NC
23	NC	32	NC
33	GND	34	NC
35	TxP0	36	NC
37	TxN0	38	NC
39	GND	40	NC
41	RxP0	42	NC
43	RxN0	44	NC

2.3 I/O Interface Descriptions

CN1 : M.2 E Key Socket

Pin	Definition	Pin	Definition
45	GND	46	NC
47	REFCLK0+	48	NC
49	REFCLK0-	50	SUSCLK
51	GND	52	PERST0#
53	NC	54	NC
55	WAKE0#	56	NC
57	GND	58	NC
59	TxP1	60	NC
61	TxN1	62	NC
63	GND	64	Pull Low
65	RxP1	66	PERST1#
67	RxN1	68	NC
69	GND	70	WAKE1#
71	REFCLK1+	72	+3.3VAUX
73	REFCLK1-	74	+3.3VAUX
75	GND		

2.3 I/O Interface Descriptions

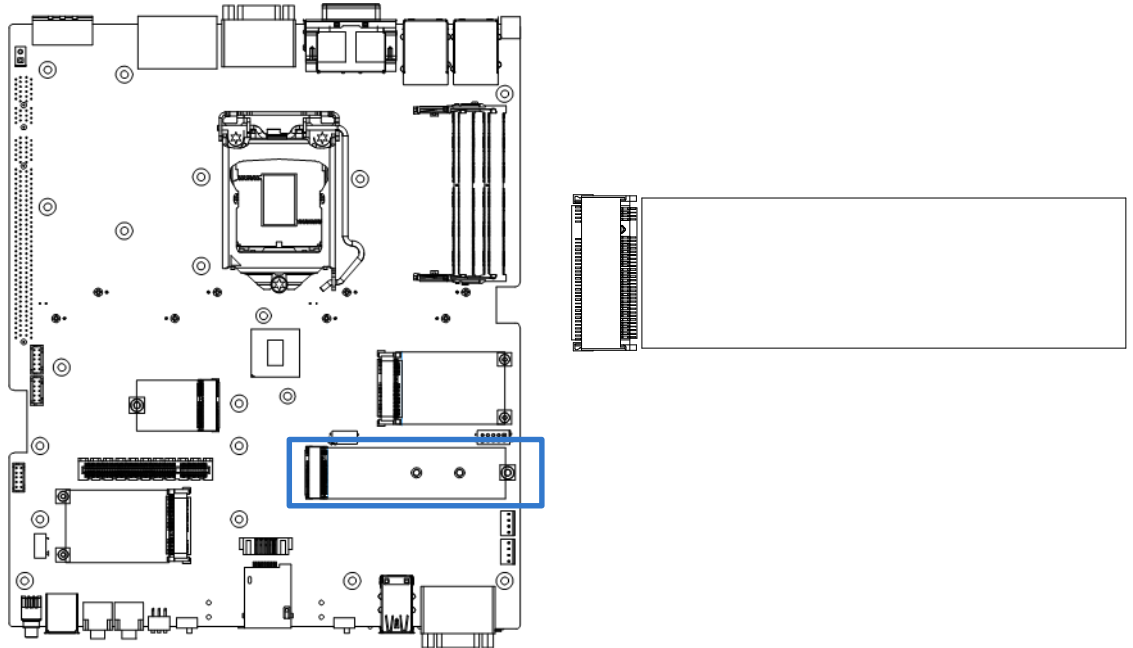

CN2 : M.2 M Key Socket

Pin	Definition	Pin	Definition
1	GND	2	+3.3V
3	GND	4	+3.3V
5	RxN3	6	NC
7	RxP3	8	NC
9	GND	10	LED#
11	TxN3	12	+3.3V
13	TxP3	14	+3.3V
15	GND	16	+3.3V
17	RxN2	18	+3.3V
19	RxP2	20	NC
21	GND	22	NC
23	TxN2	24	NC
25	TxP2	26	NC
27	GND	28	NC
29	RxN1	30	NC
31	RxP1	32	NC
33	GND	34	NC
35	TxN1	36	NC

2.3 I/O Interface Descriptions

CN2 : M.2 M Key Socket

Pin	Definition	Pin	Definition
37	TxP1	38	Pull Low
39	GND	40	NC
41	RxNO/SATA_B+	42	NC
43	RxPO/SATA_B-	44	NC
45	GND	46	NC
47	TxNO	48	NC
49	TxPO	50	PERST#
51	GND	52	Pull Hi
53	REFCLK-	54	WAKE#
55	REFCLK+	56	NC
57	GND	58	NC
67	NC	68	SUSCLK
69	PEDET	70	+3.3V
71	GND	72	+3.3V
73	GND	74	+3.3V
75	GND		

Chapter 3

System Setup

3.1 Set torque force to 3.5 kgf-cm to execute all the screwing and unscrewing.

3.2 Removing heat sink cover

**WARNING**

In order to prevent electric shock or system damage, before removing the chassis cover, must turn off power and disconnect the unit from power source.



1. Unscrew the 4 screws on the top side of computing module

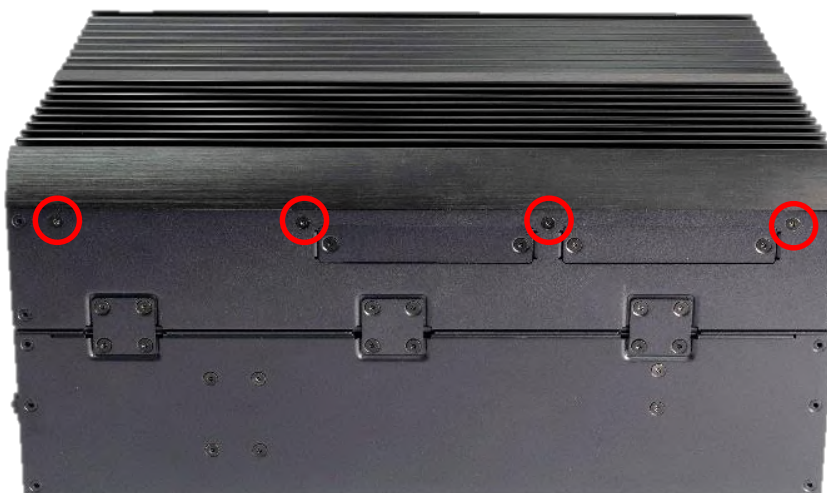

2. Unscrew the 4 screws on the bottom side.

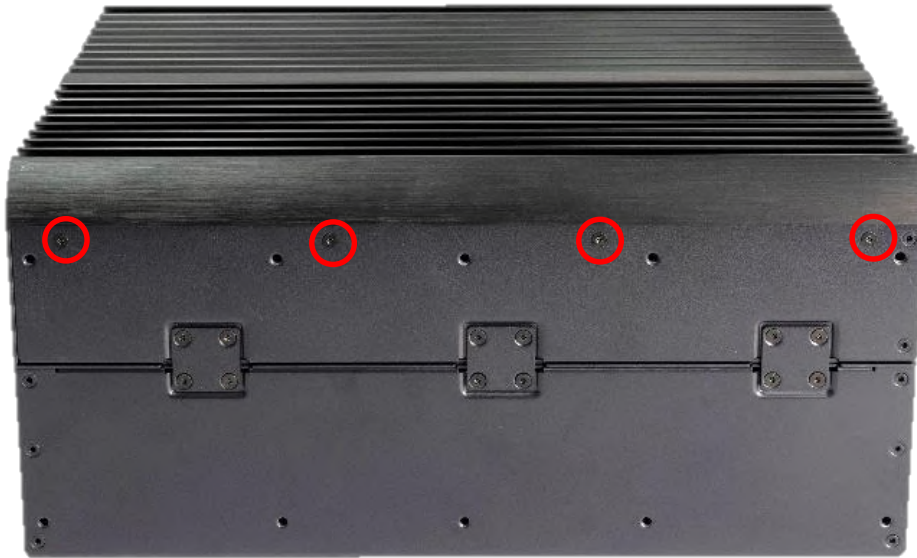

3. Now you can remove the heat sink cover.



3.3 Disconnecting expansion module from computing module

1. Remove the 3 connecting brackets on the top side of the system and the 3 brackets on the bottom side.



2. Now you can separate the expansion module from the computing module.



3.4 Removing chassis bottom cover

1. Unscrew the 6 screws highlighted below.

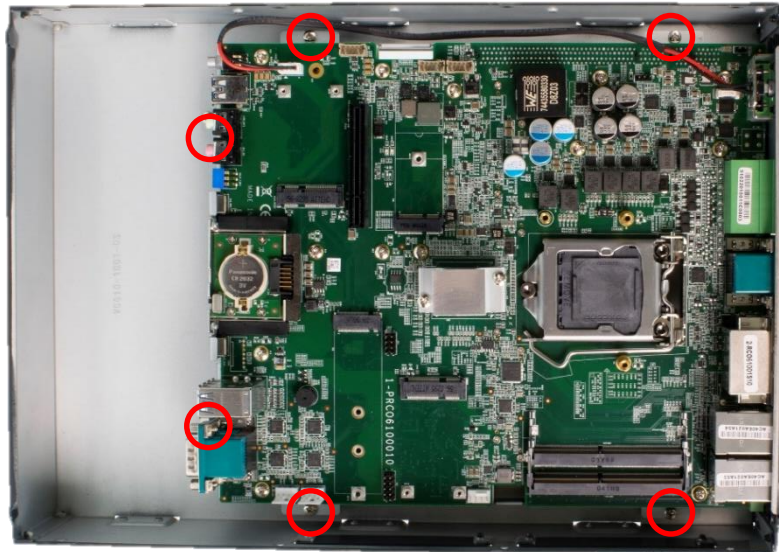

2. Unscrew 4 screws on the front side.



3. Hold the body of the system and lift it vertically away.

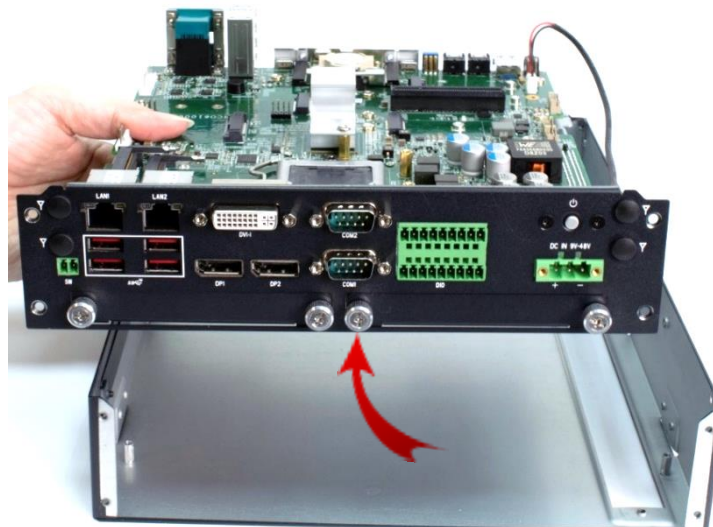

3.5 Install HDD/SSD on the internal SATA bay

1. Two internal SATA HDD/SSD bays are available for RCO-6100 series.

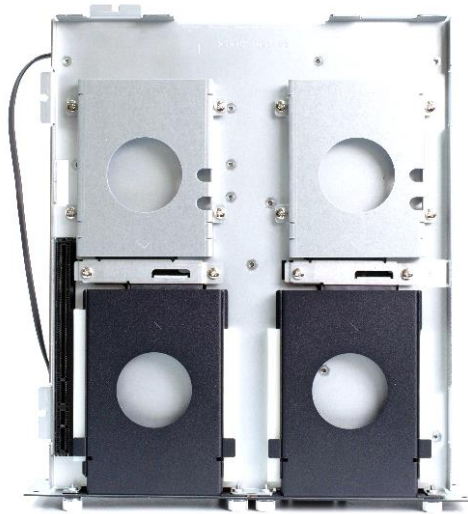

2. Unscrew the 4 screws (M3x5L) to remove the internal SATA HDD/SSD bay.

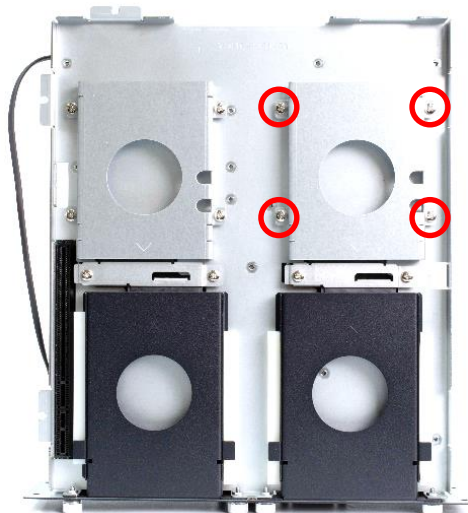

3. Lock the 2.5" HDD with HDD/SSD bracket using four screws (M3x4L).

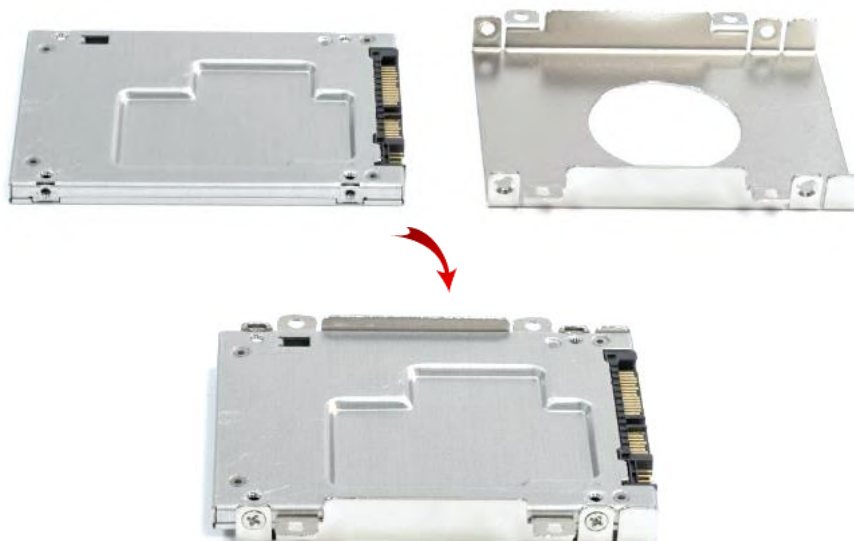

4. Install the HDD/SSD bracket following the direction below.

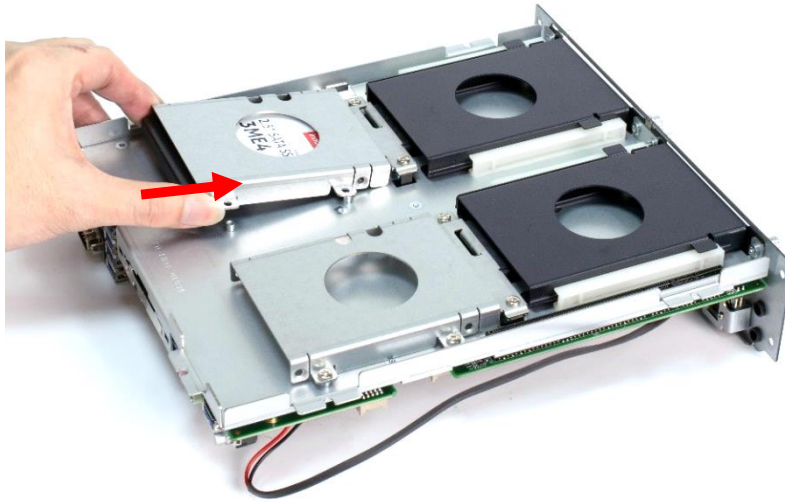

5. Fasten the 4 screws to lock the internal HDD/SSD bracket.

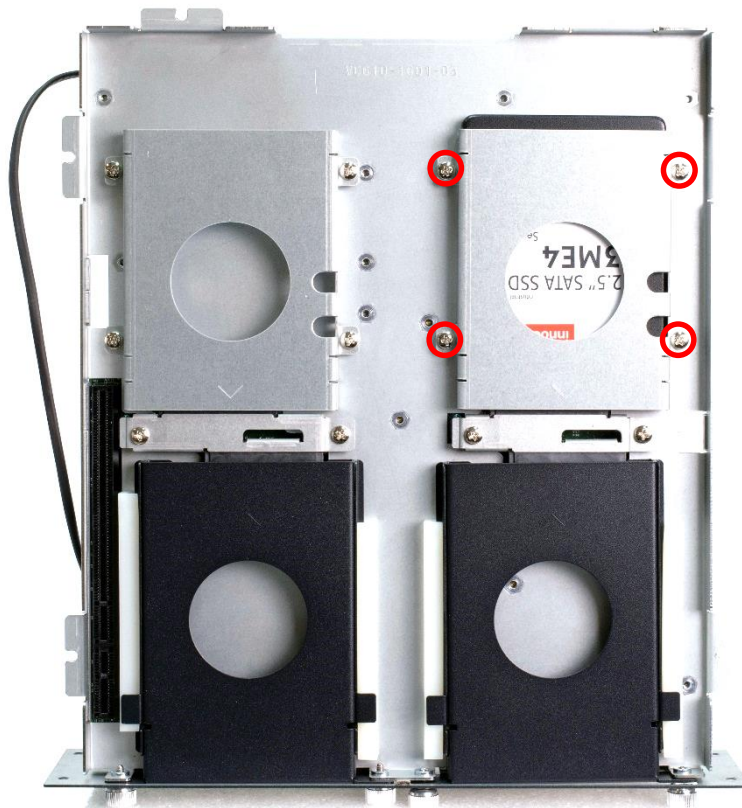

3.6 Installing HDD on removable SATA HDD bay

Two removable SATA HDD bays are available for VCO-6000 Series.

1. Unscrew the two sun screws circled below to take out the removable SATA HDD bay.

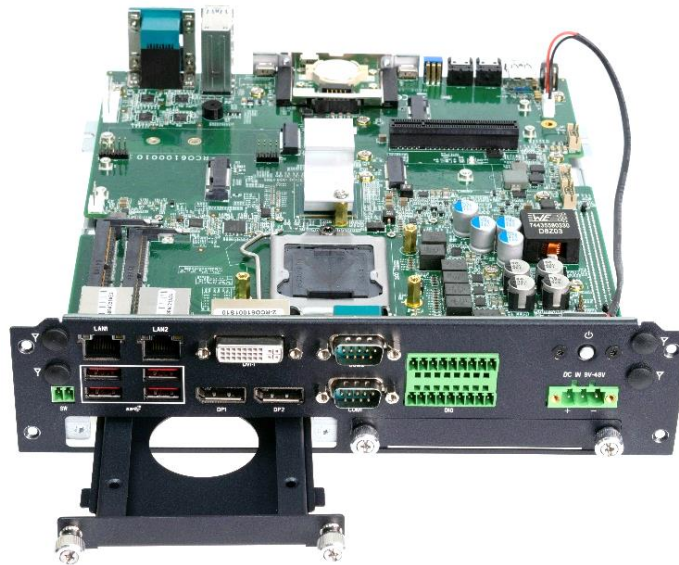
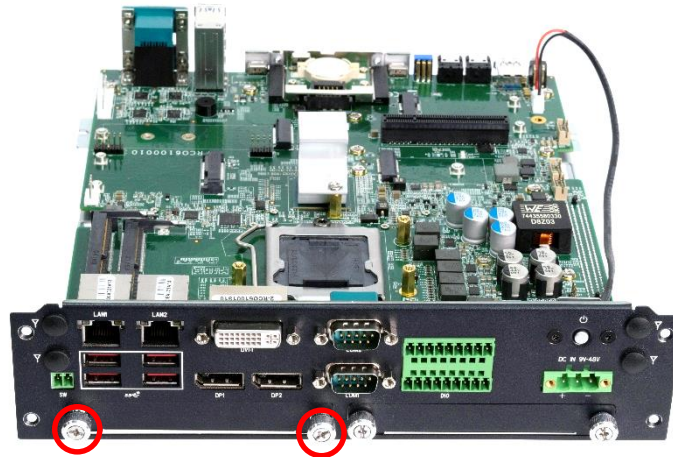

2. Lock the 2.5" HDD with HDD bracket using 4 screws.

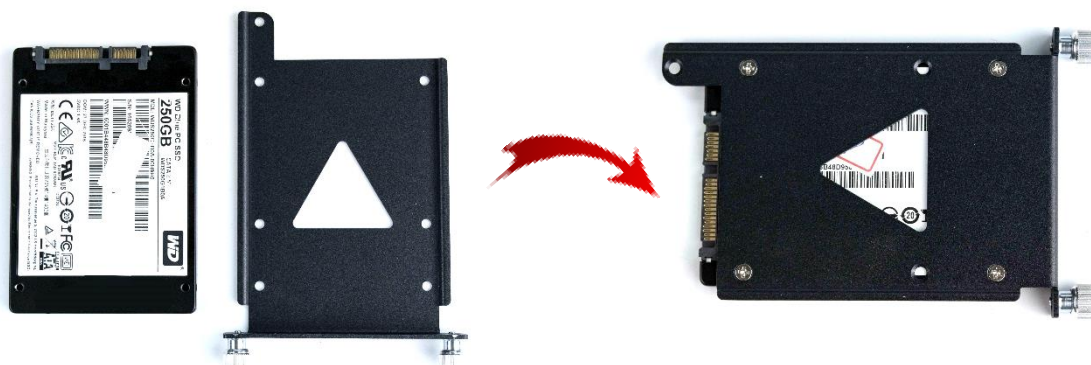

3. Slide the HDD bracket back and then fasten the sun screws.

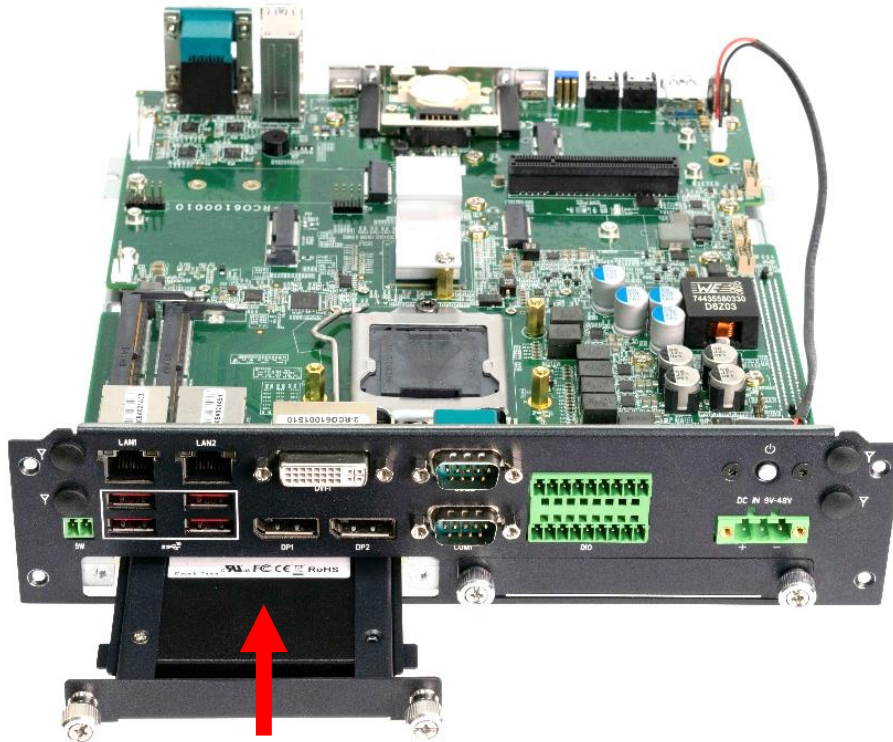

4. Installation complete



3.7 Installing SODIMM

1. Place the system body with SODIMM socket facing upward. Two SODIMM sockets are available for RCO-6100 series on the top side.

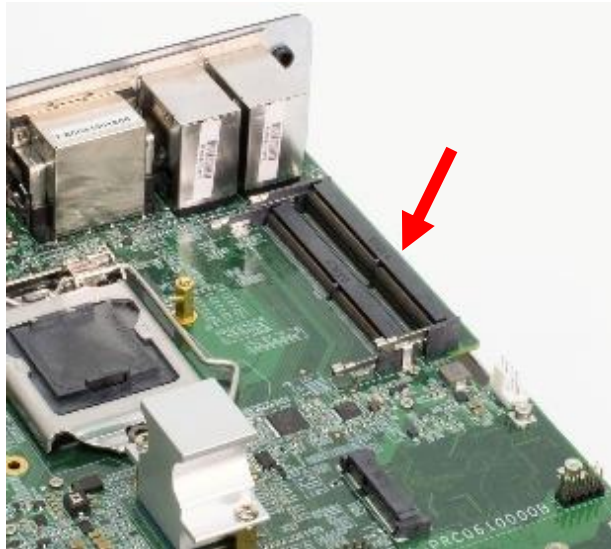

2. Insert memory module from 45 degree direction.



3. Press the memory module vertically downward until you hear the “click” sound. Make sure the memory module is firmly in place.

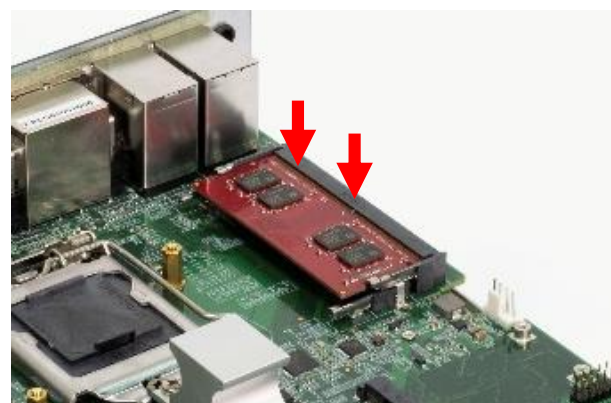

3.8 Installing CPU

1. Press down the CPU socket lever in order to open the socket cover.

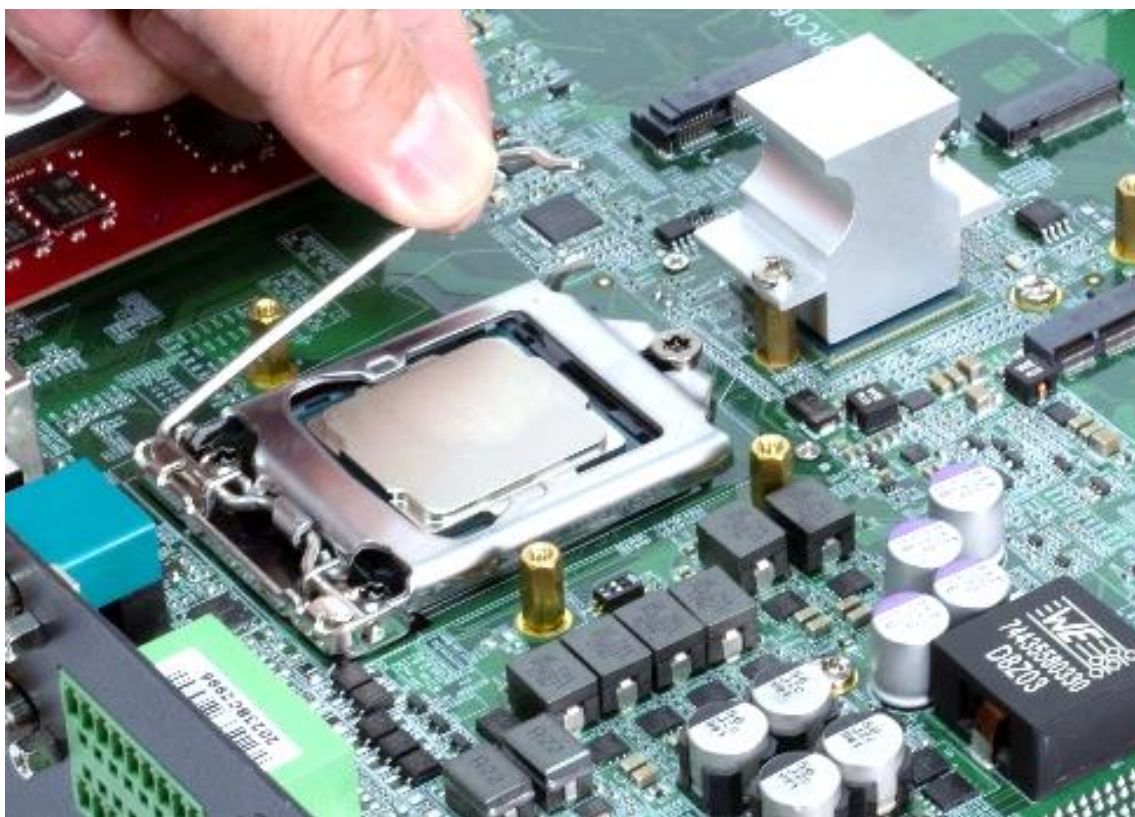

2. Remove the CPU protective cover.



3. Insert CPU gently.



4. Press down the lever again to hold the socket cover.



5. Paste thermal pad on the CPU.



6. Place the designated heat block onto the CPU with thermal pad.



7. Lock the heat block with three screws (M3x5L). Screw driver will be able to penetrate through the holes on the top in order to fasten the screws with copper stud.

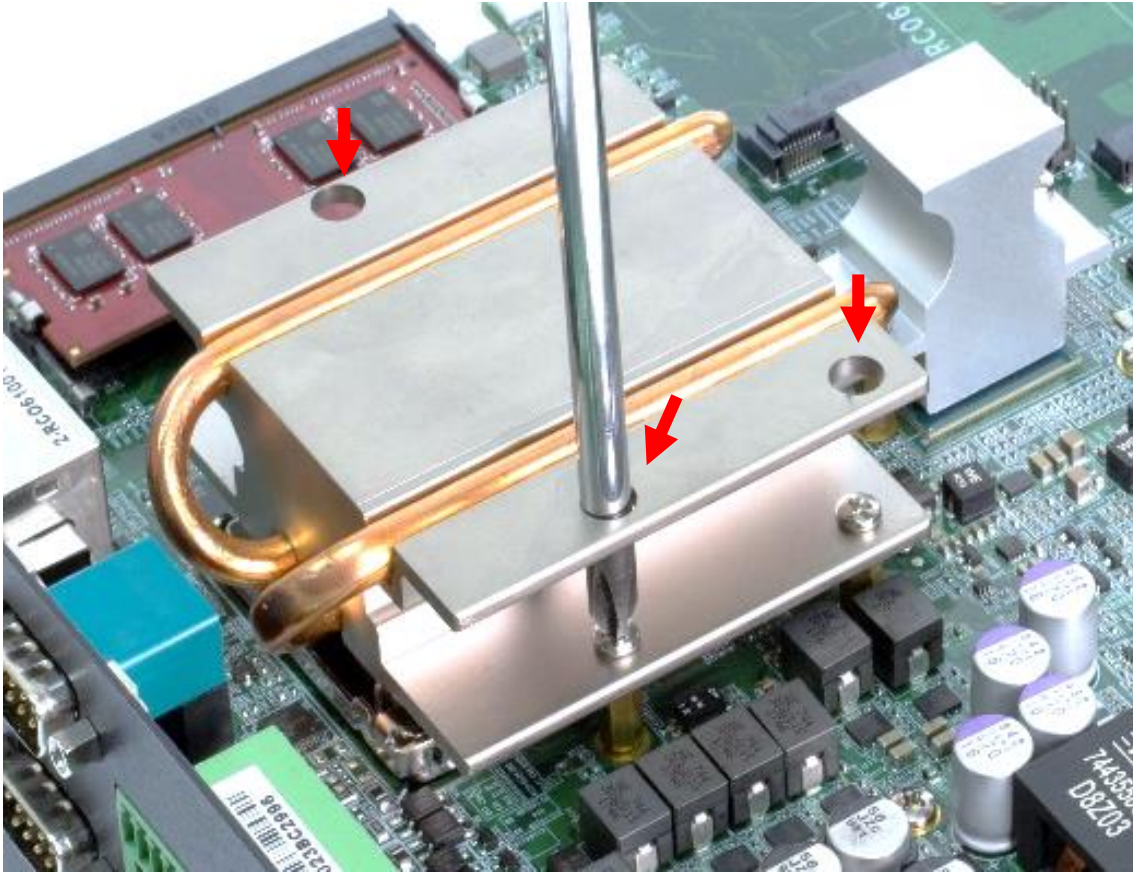

8. Paste the thermal pad onto the installed heat block.



9. Paste the thermal pad onto the installed heat block.



3.9 Installing Mini PCIe card / mSATA

The RCO-6100 series has two Mini PCIe slots, both of which are on the top. The MINI-PCI E1 on the top supports mSATA.

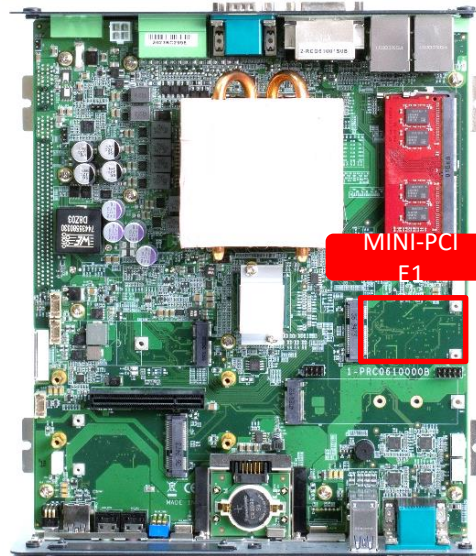

1. Insert Mini PCIe card from 45 degree direction.

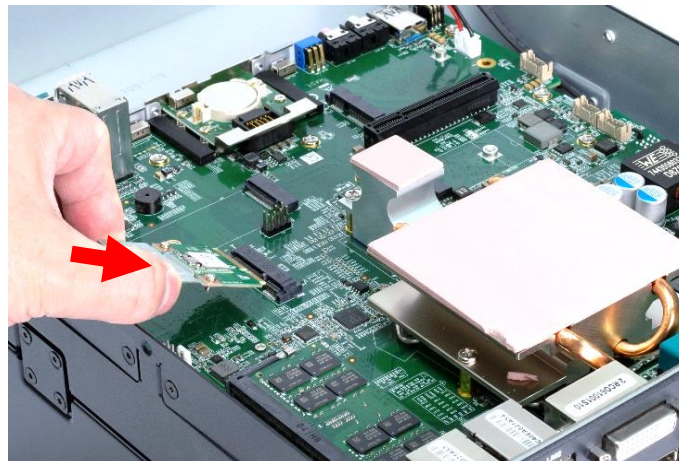

2. Press the Mini PCIe card down and lock it with two screws (M2x3.7L).

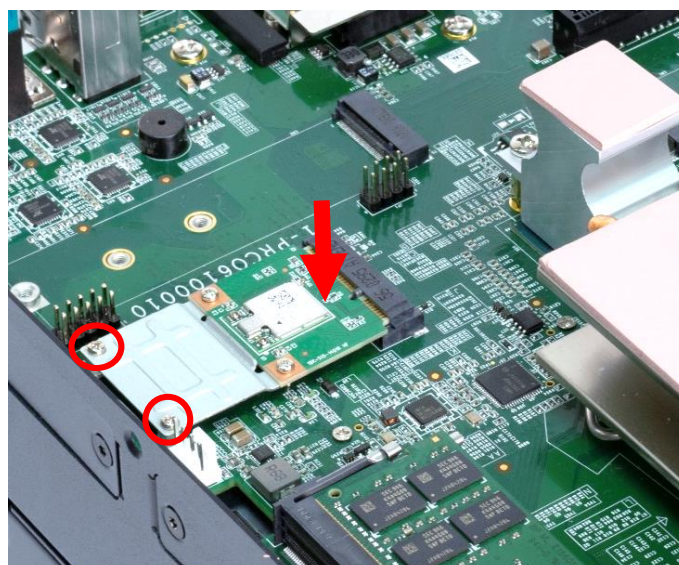

3.10 Installing M.2 2280 NVMe SSD

RCO-6100 series PCBA has an M.2 M key slot on the top, CN2 currently supports NVMe SSD applications

1. Insert M.2 M Key card from 45 degree direction.

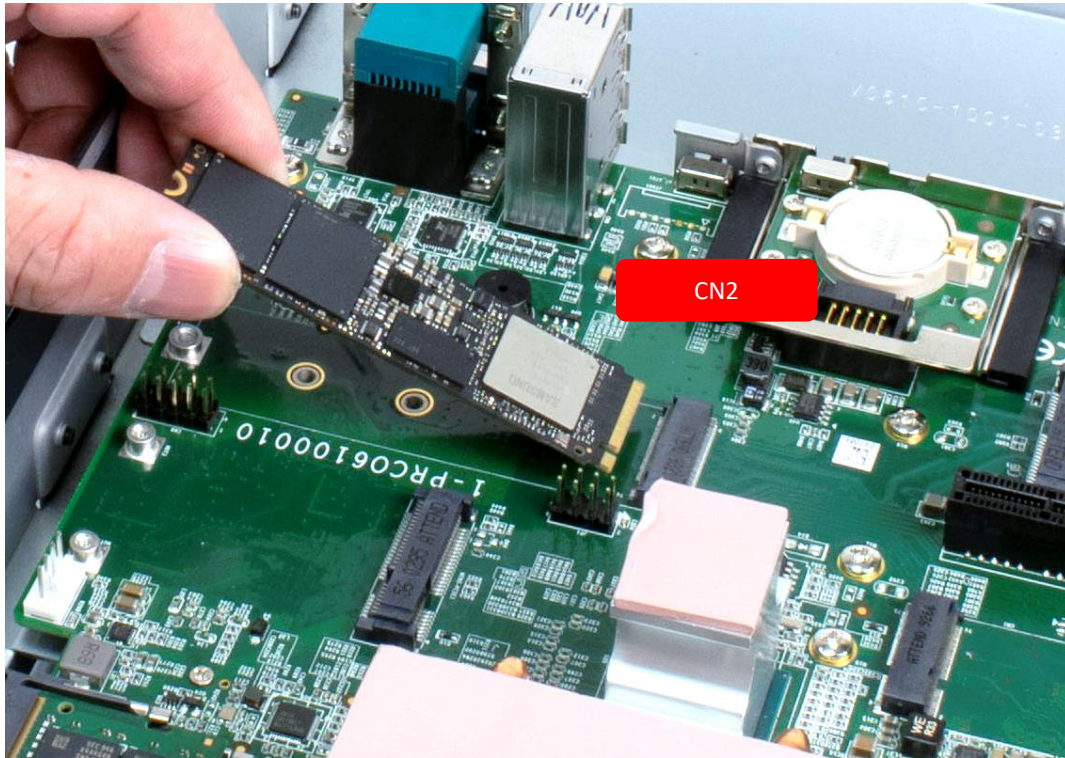

2. Press the M.2 M Key card down and lock it with one screw (M2x3.7L).

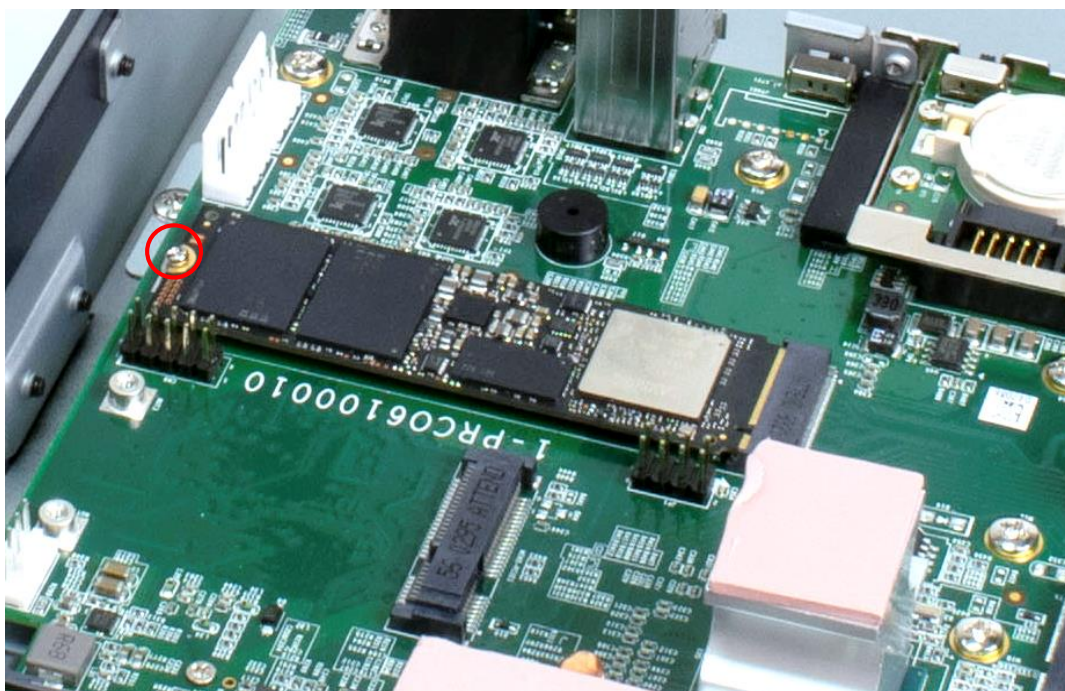

3.11 Installing WiFi Module

RCO-6100 series PCBA has an M.2 E key slot on the top, CN1 currently supports WiFi application

1. Insert M.2 E Key card from 45 degree direction.

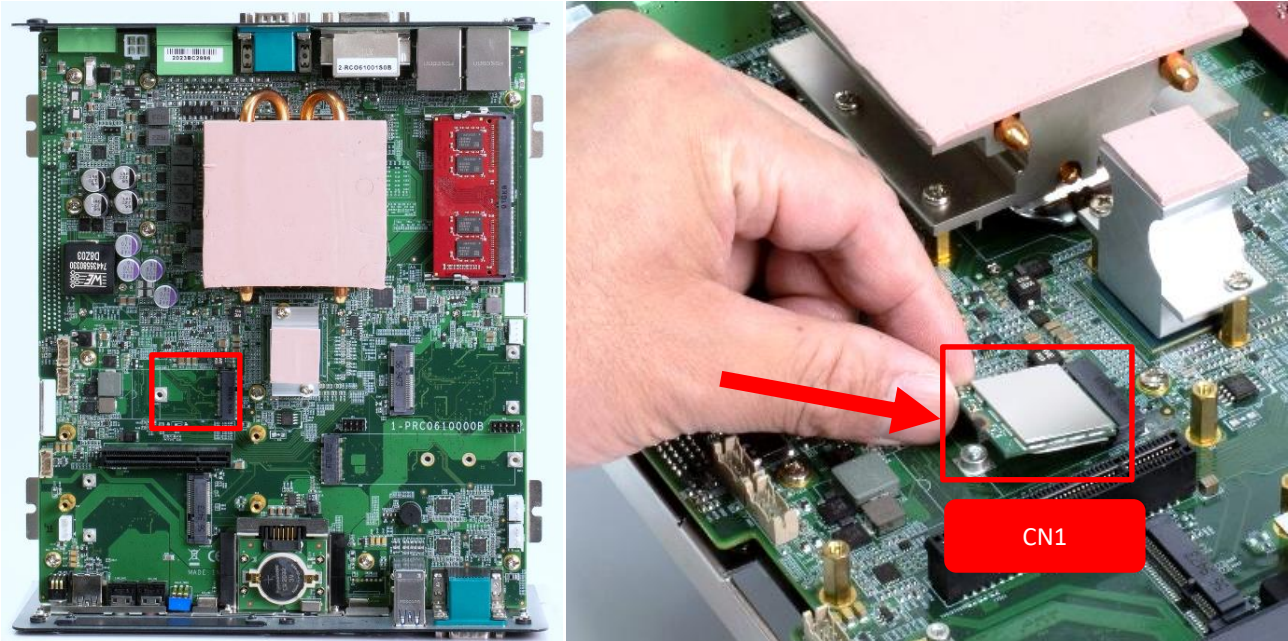

2. Press the M.2 E Key card down and lock it with one screw (M2x3.7L).

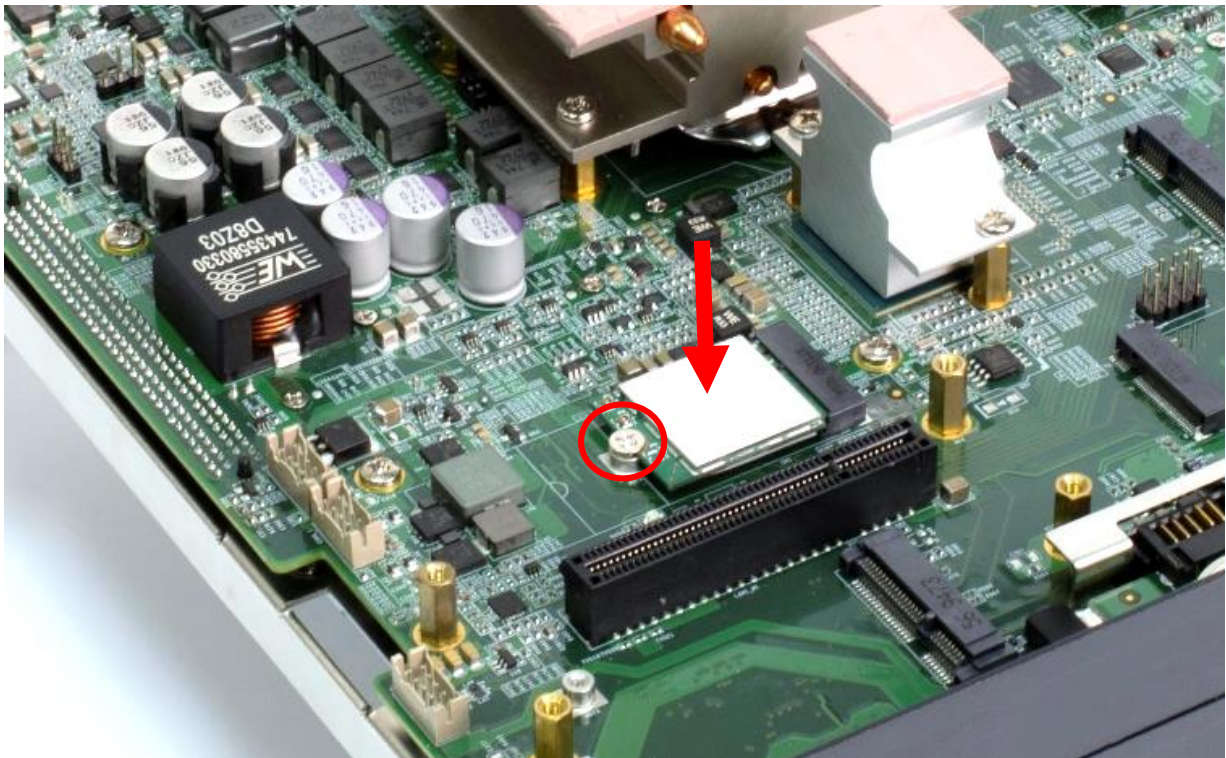

3. RCO-6100 series system has 4 antenna holes, remove antenna hole plug on the system panel.

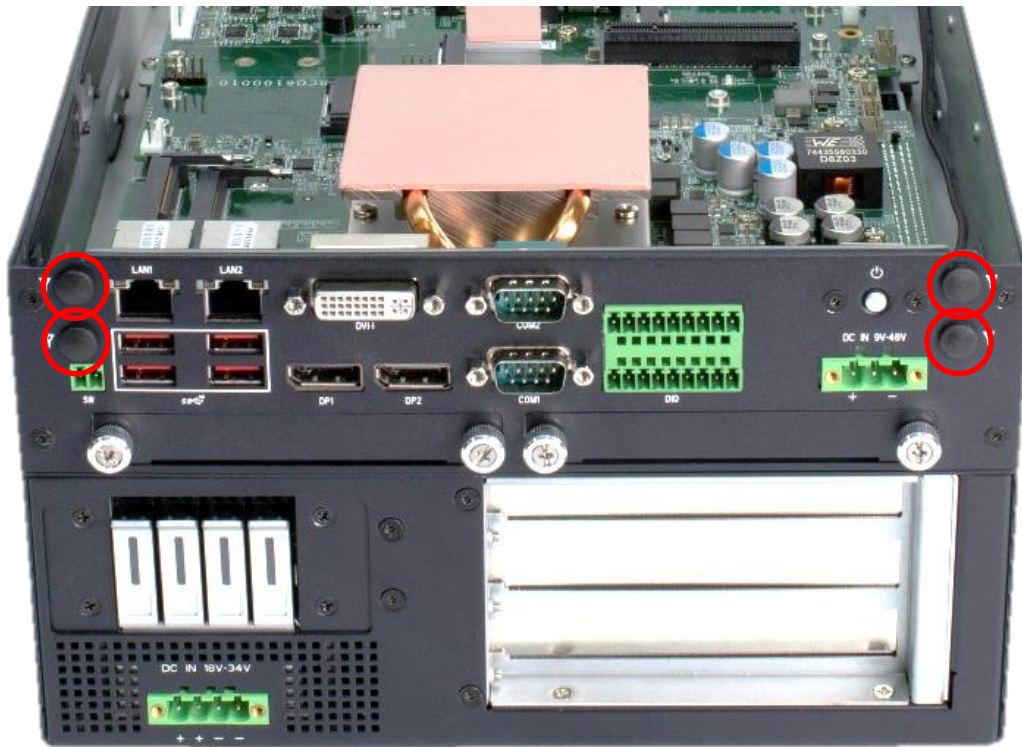

4. Have antenna jack penetrate through the hole, and fasten the nut with SMA jack.



5. Assemble the antenna and SMA jack together.

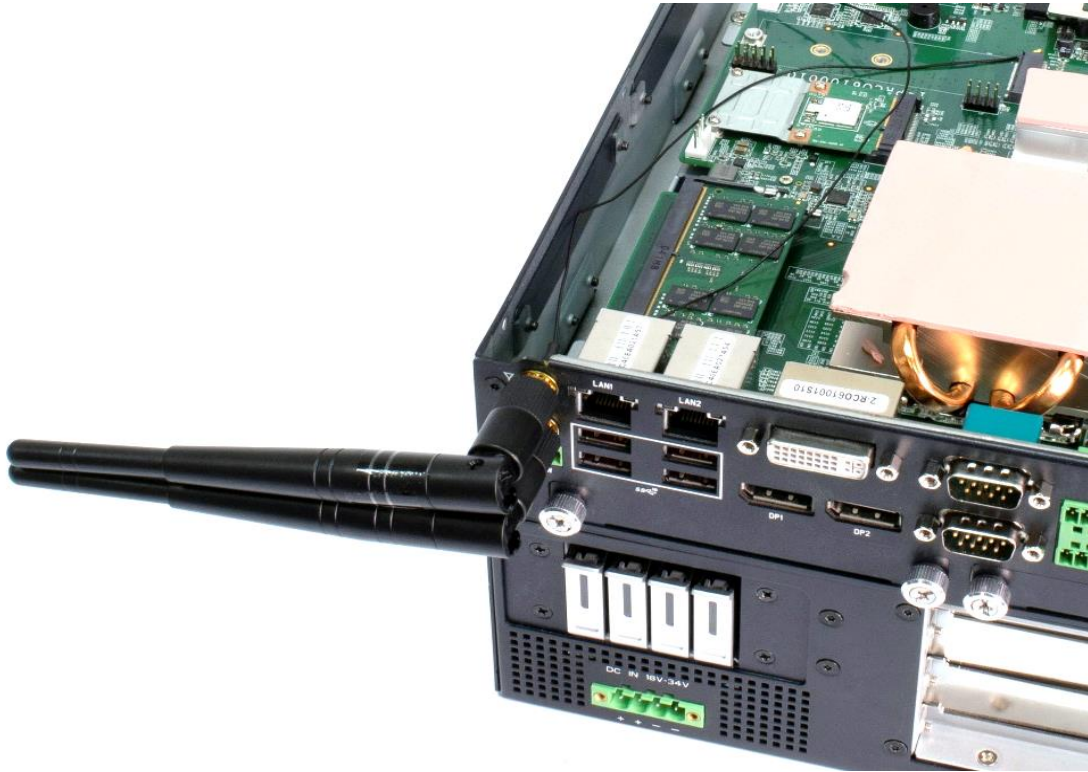

6. Attach the RF connector at the cable-end onto the communication module.

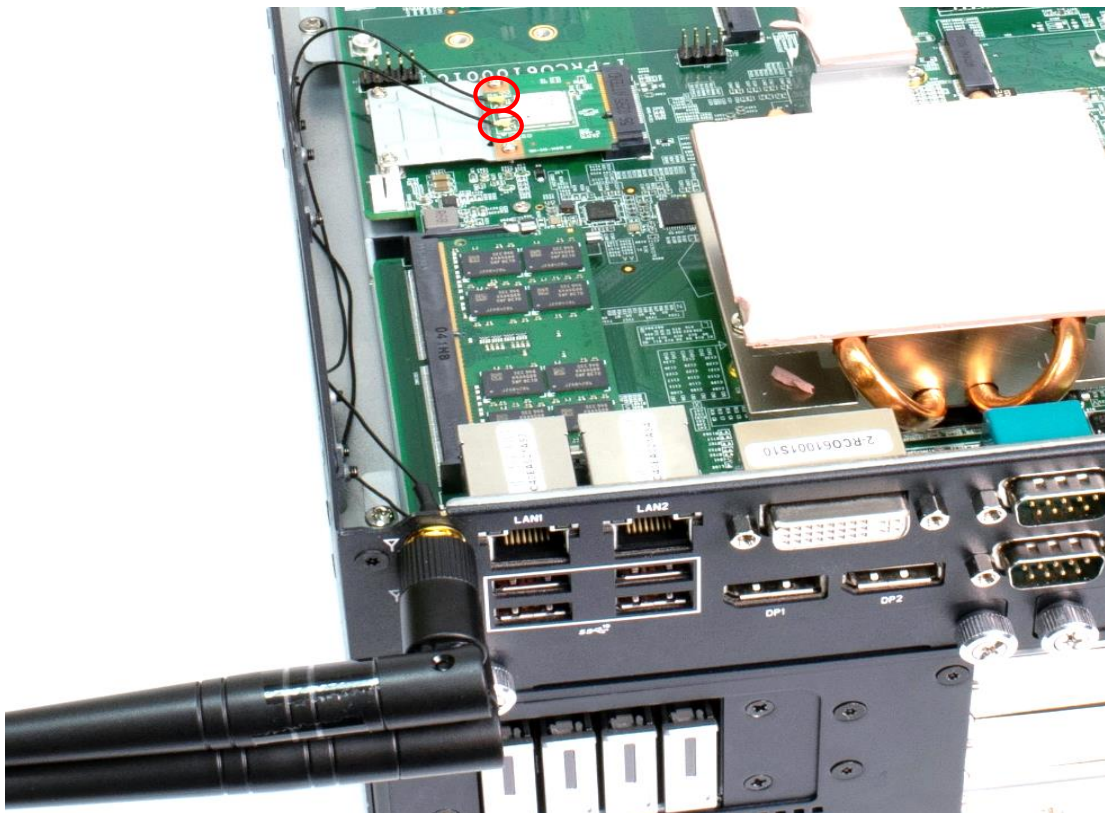

3.12 Installing Mini PCIe card / 4GLTE

RCO-6100 series PCBA has two Mini PCIe slots on the top, MINI-PCI E2 currently supports 4GLTE applications

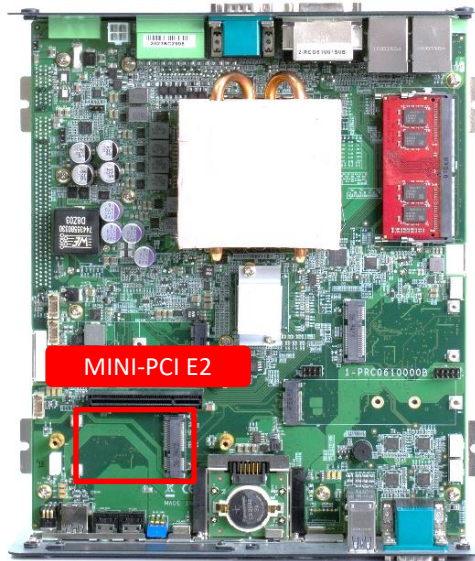

1. Insert Mini PCIe card from 45 degree direction.

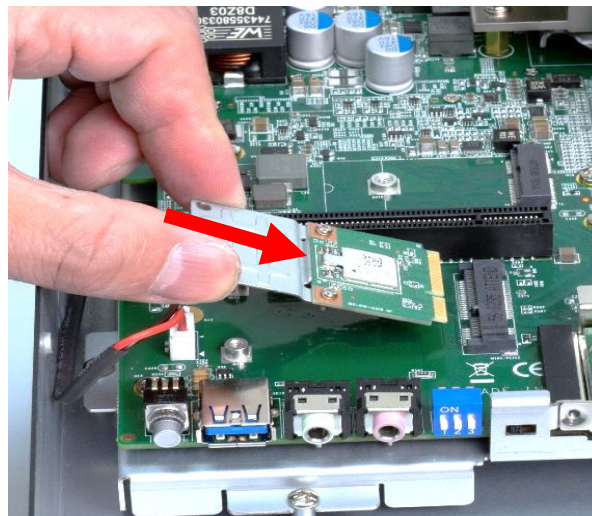

2. Press the Mini PCIe card down and lock it with two screws (M2x3.7L).

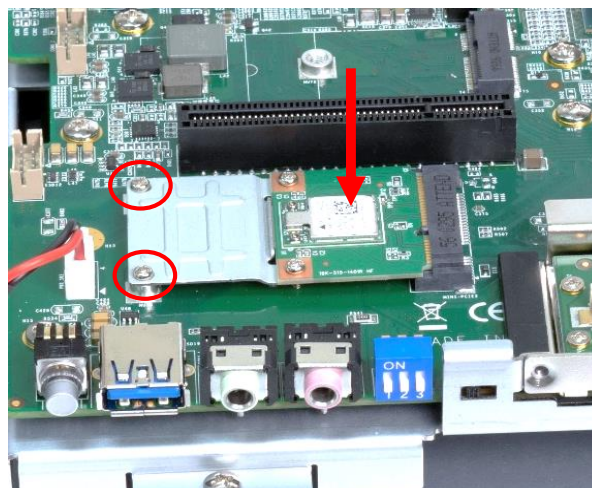

3.13 Installing antenna

1. Remove antenna hole cover on the system panel.

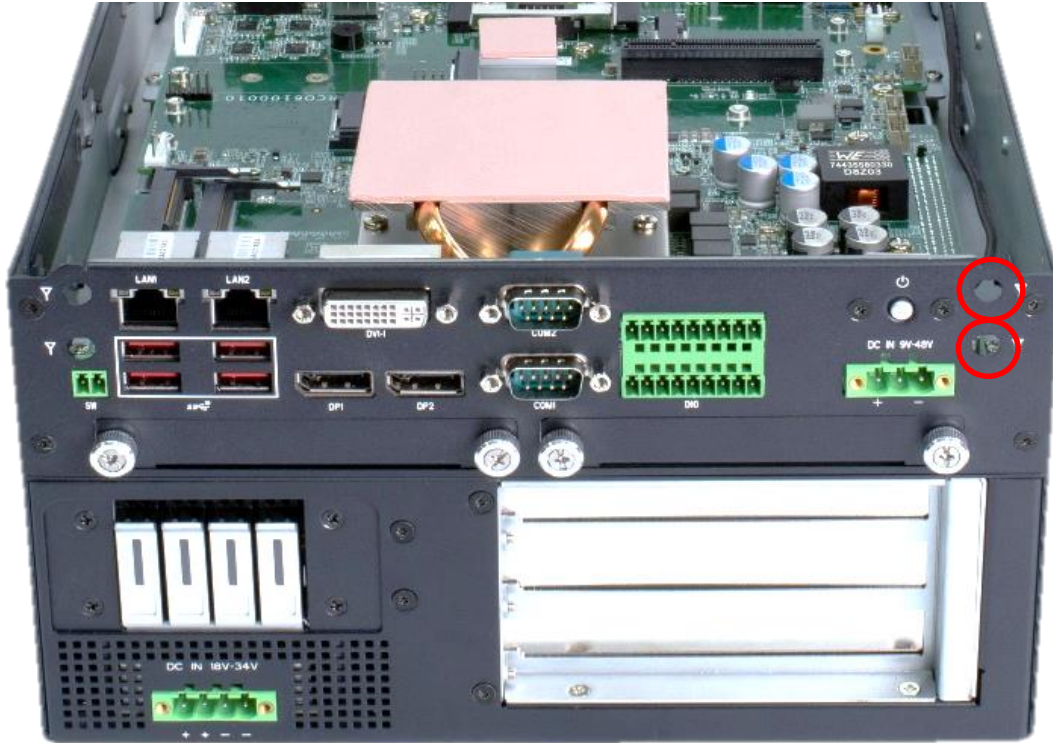

2. Have antenna jack penetrate through the hole, and fasten the nut with SMA jack



3. Assemble the antenna and SMA jack together.

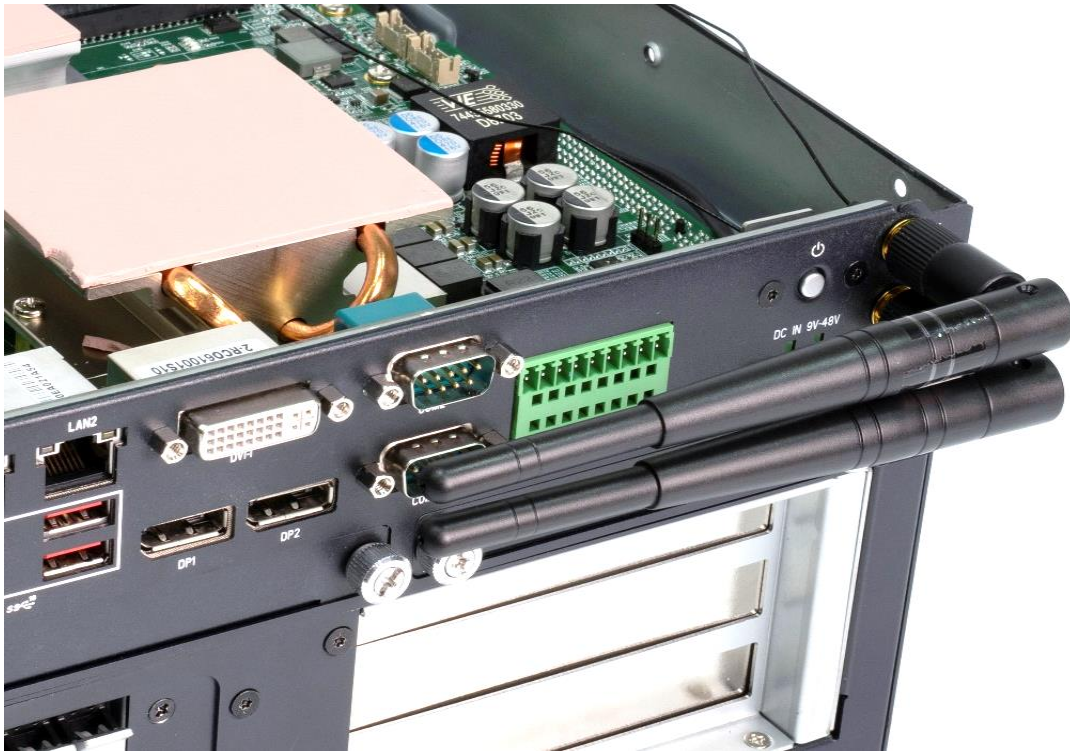

4. Attach the RF connector at the cable-end onto the communication module.

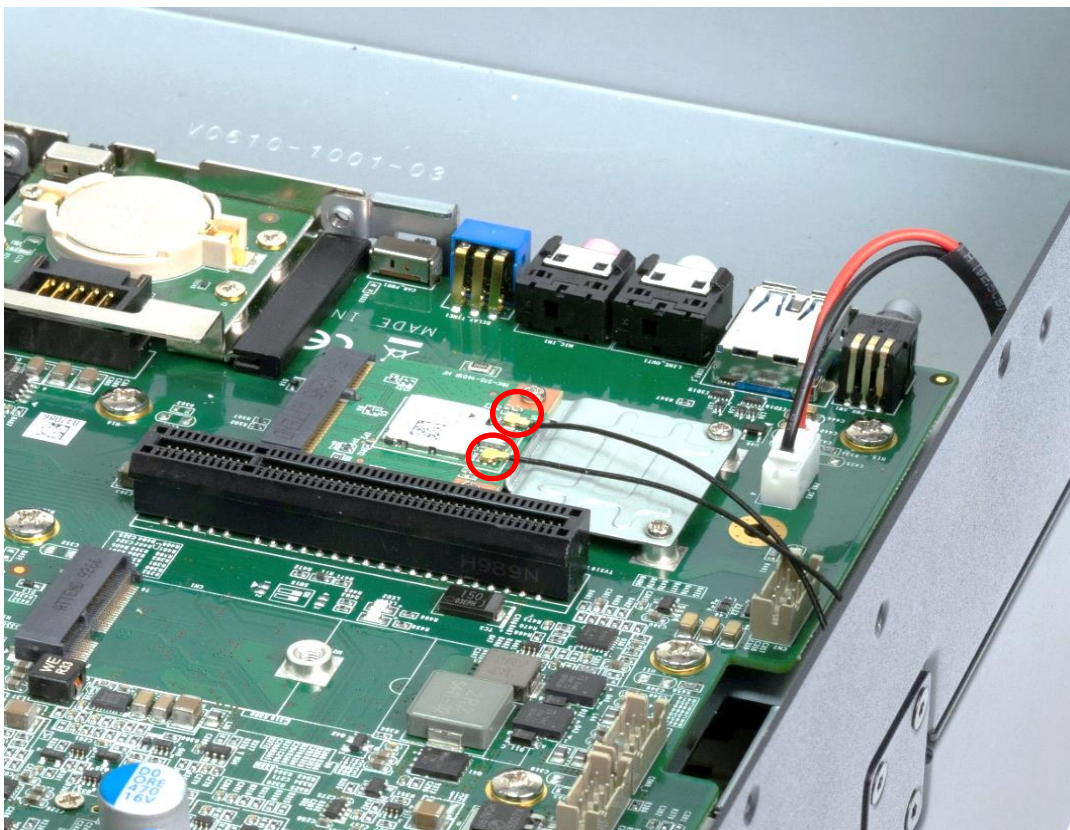

3.14 Installing graphic Card

1. Remove the 6 screws in the circle below.



2. Push the chassis cover following the below direction to open the expansion module.



3. Now you can remove the top cover.



4. Remove the 11 screws in the circle below



5. Now you can remove the graphic card expansion module.

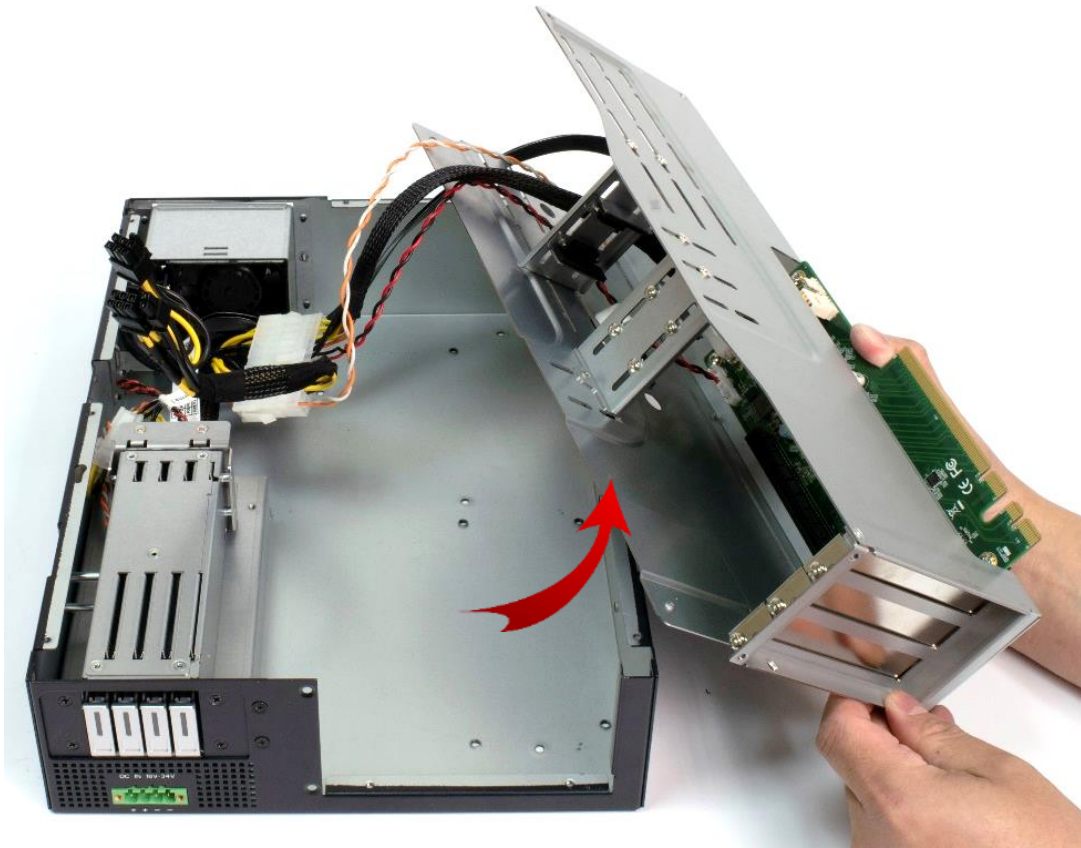

6. Remove the power cable.



7. Remove the SFF 8654 x8 cable.

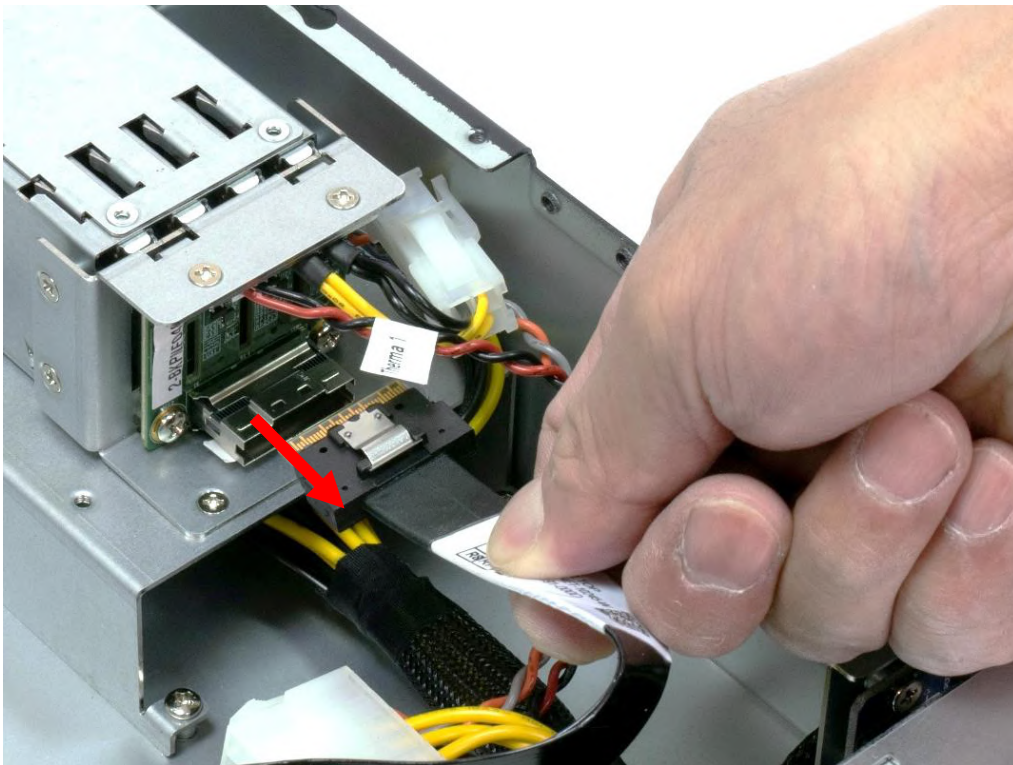
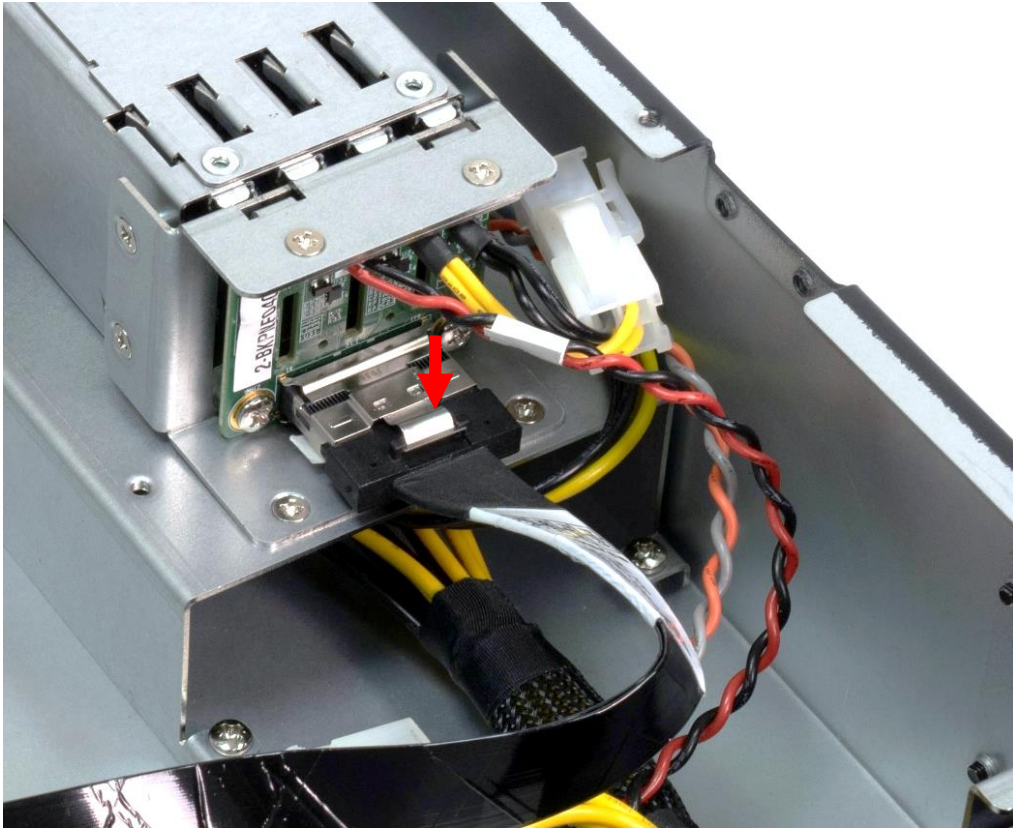

8. Unscrew the 5 screws highlighted below.

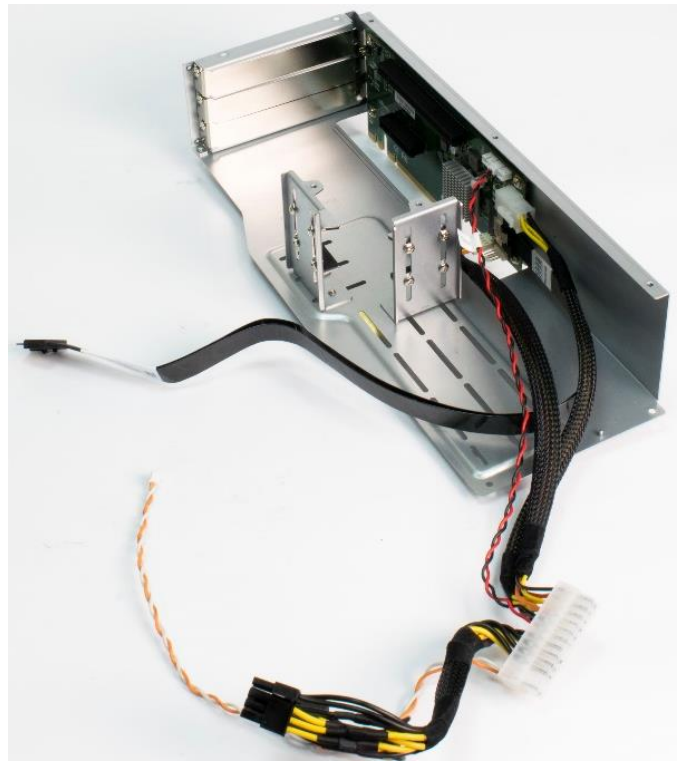
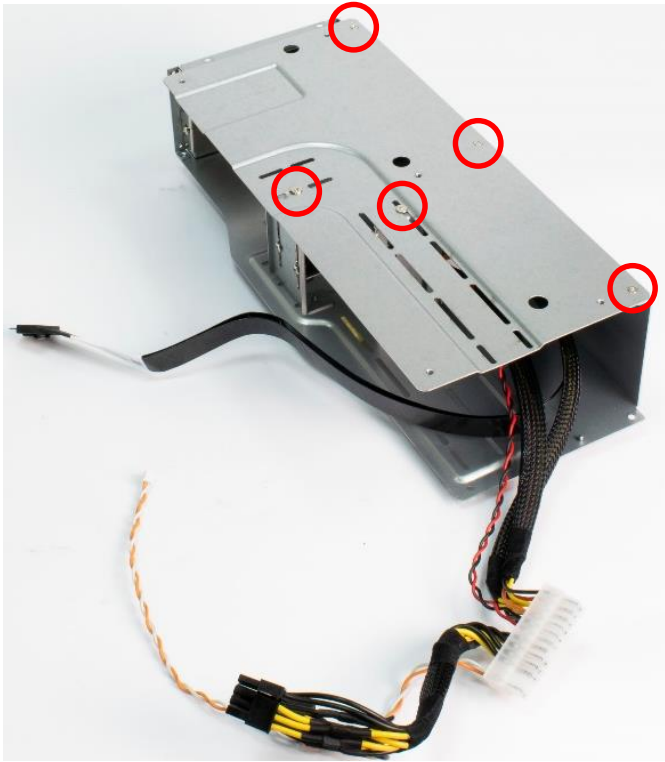

9. Unscrew the 4 screws highlighted below.

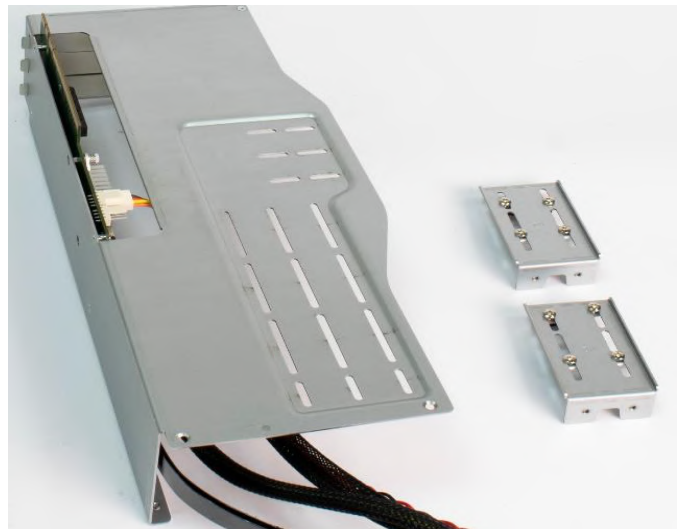
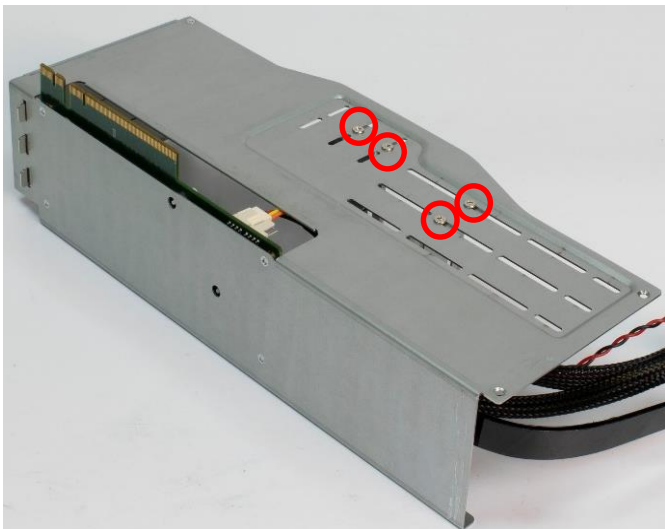

10. Unscrew the screw to remove the I/O shield.

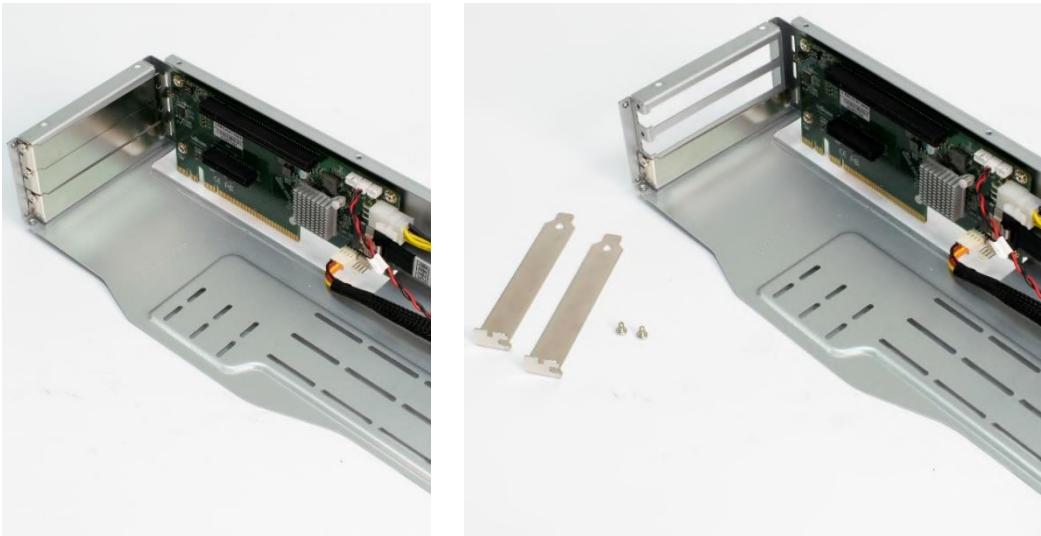

11. Install the graphic card according to the below direction and ensure the gold finger is inserted into the slot.

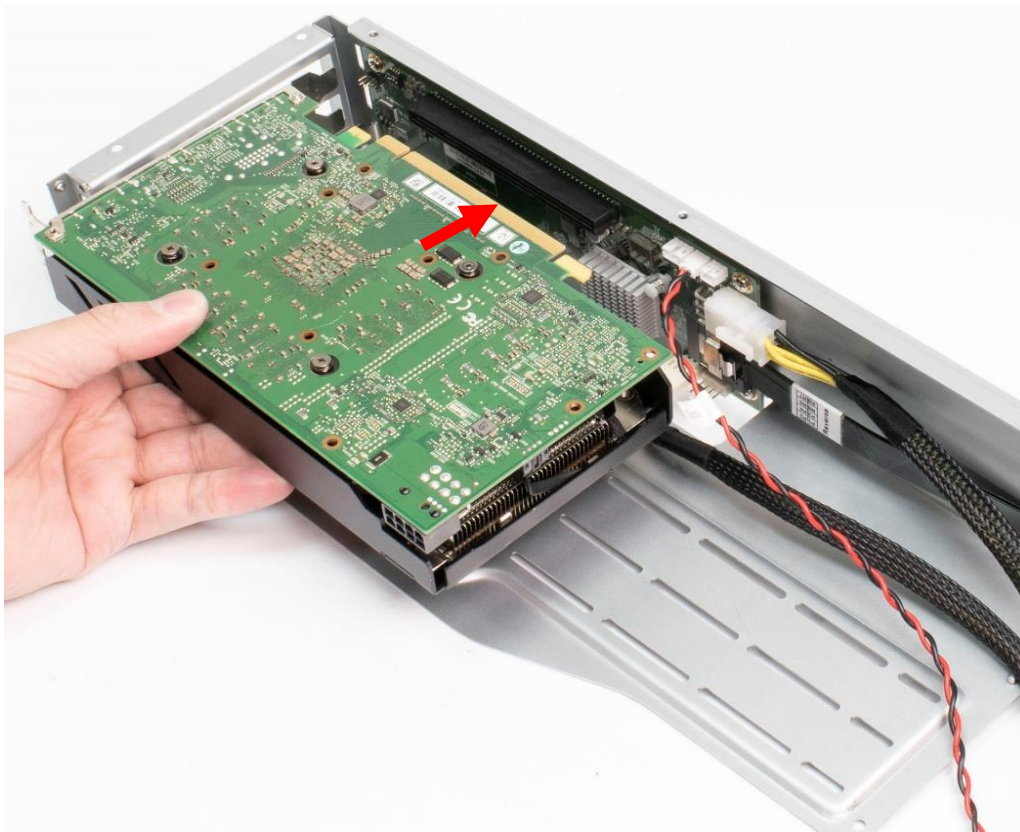

12. Install the screw back to secure the graphic card.

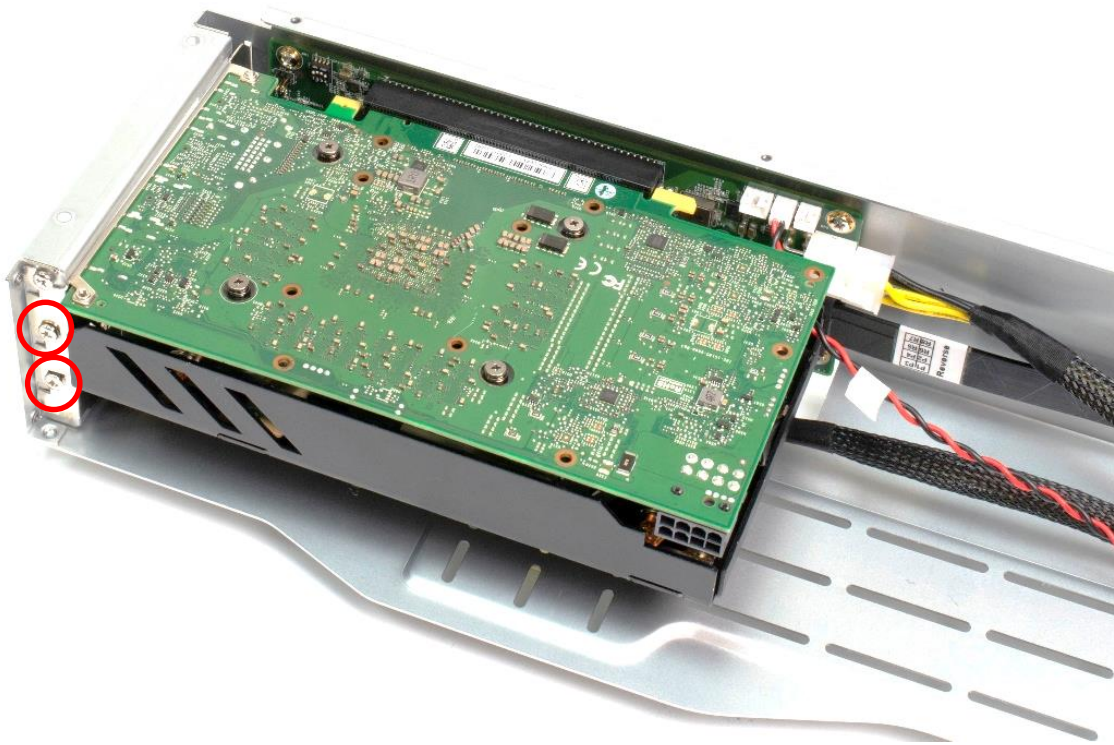

13. Insert power cable from the power board to the graphic card.



14. Adjust the arm until it holds the card firmly in place.



15. Then fasten the screw on the holder.

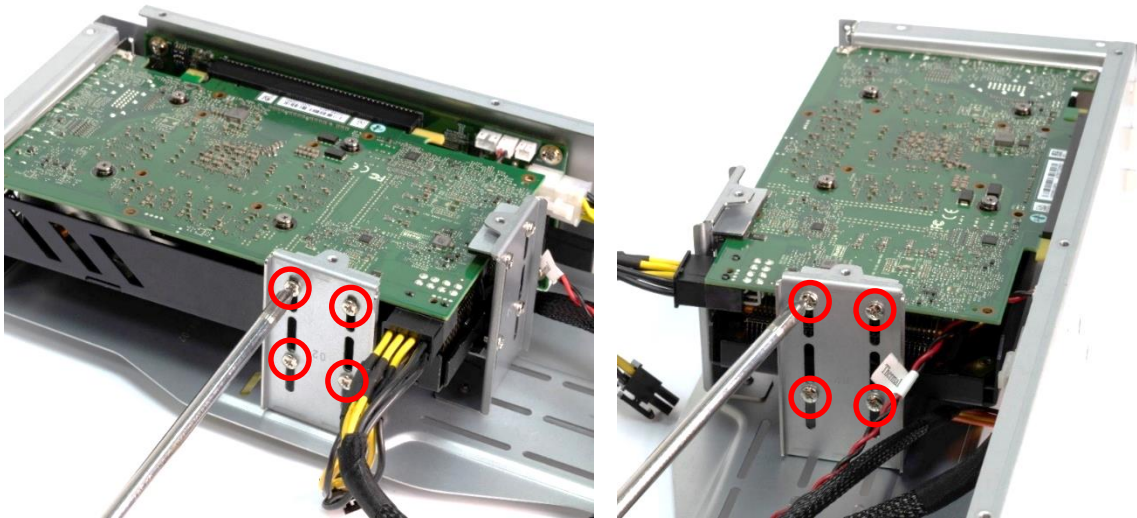

16. Fasten the 4 screws.

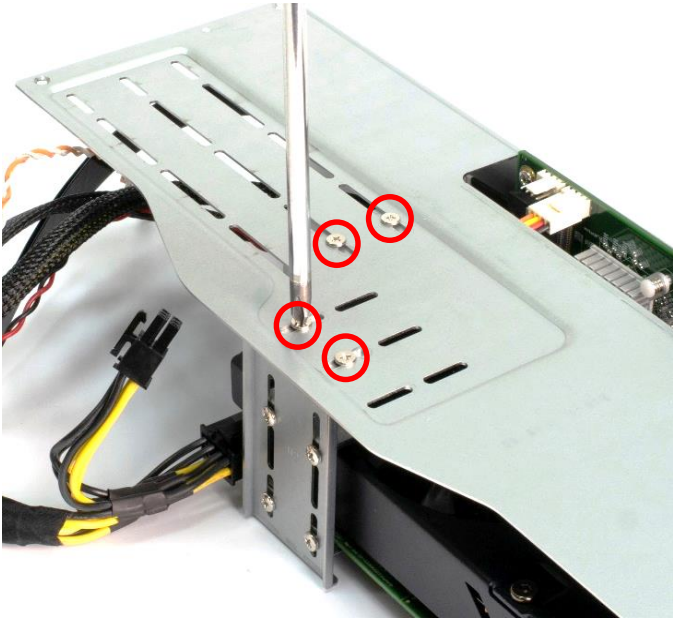

17. Fasten the 2 screws.

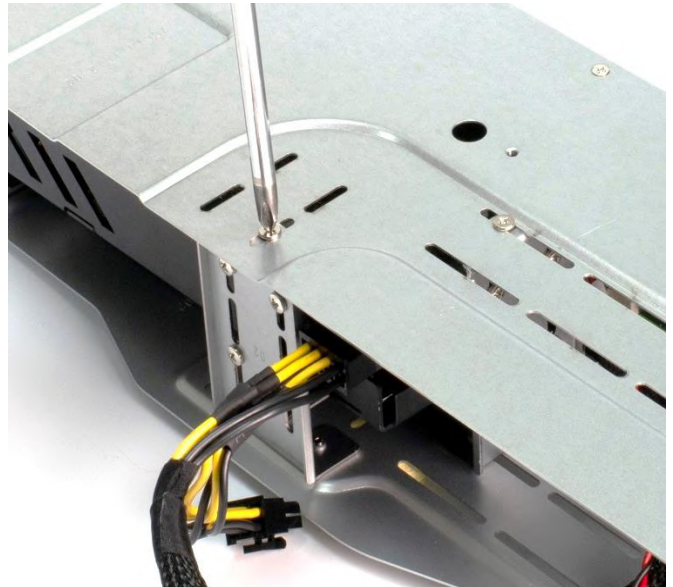
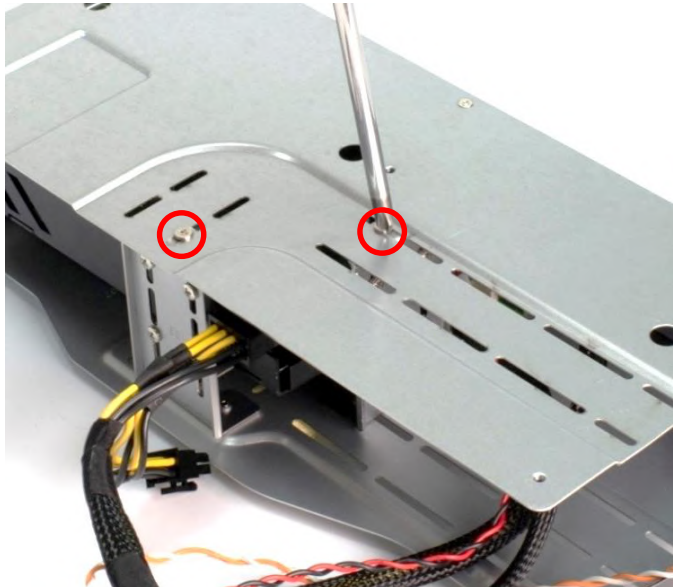

18. Put the graphic expansion module into the expansion chassis.



19. Fasten the 11 screws.

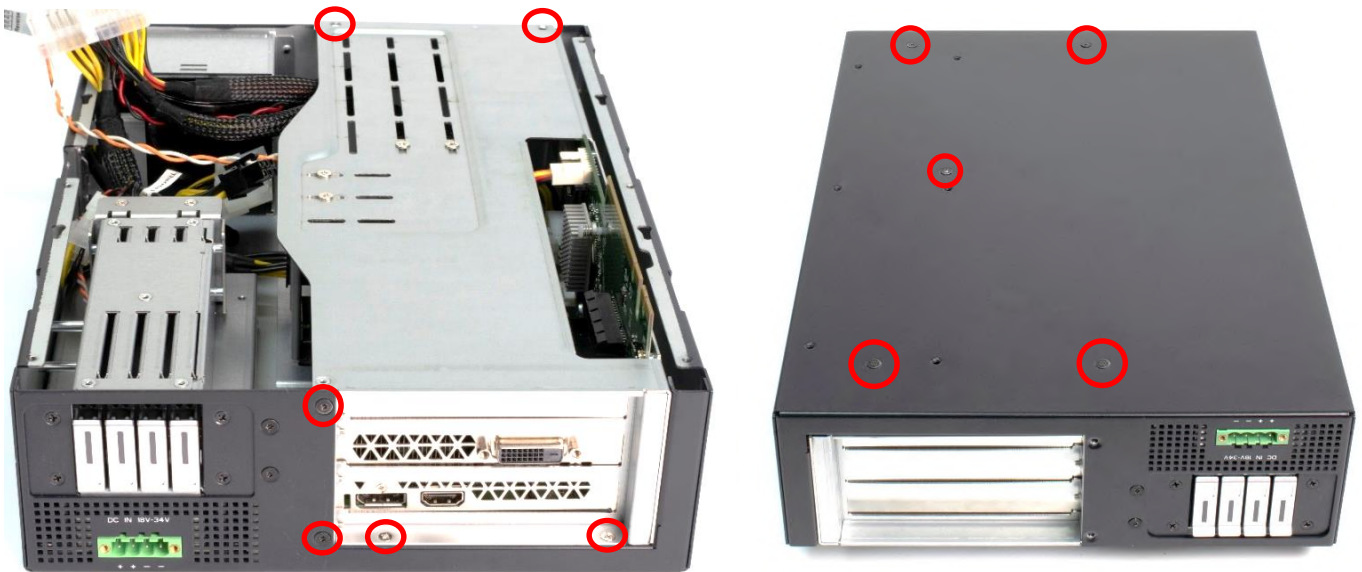

20. Insert the power cable.



21. Insert the SFF 8654 x8 cable

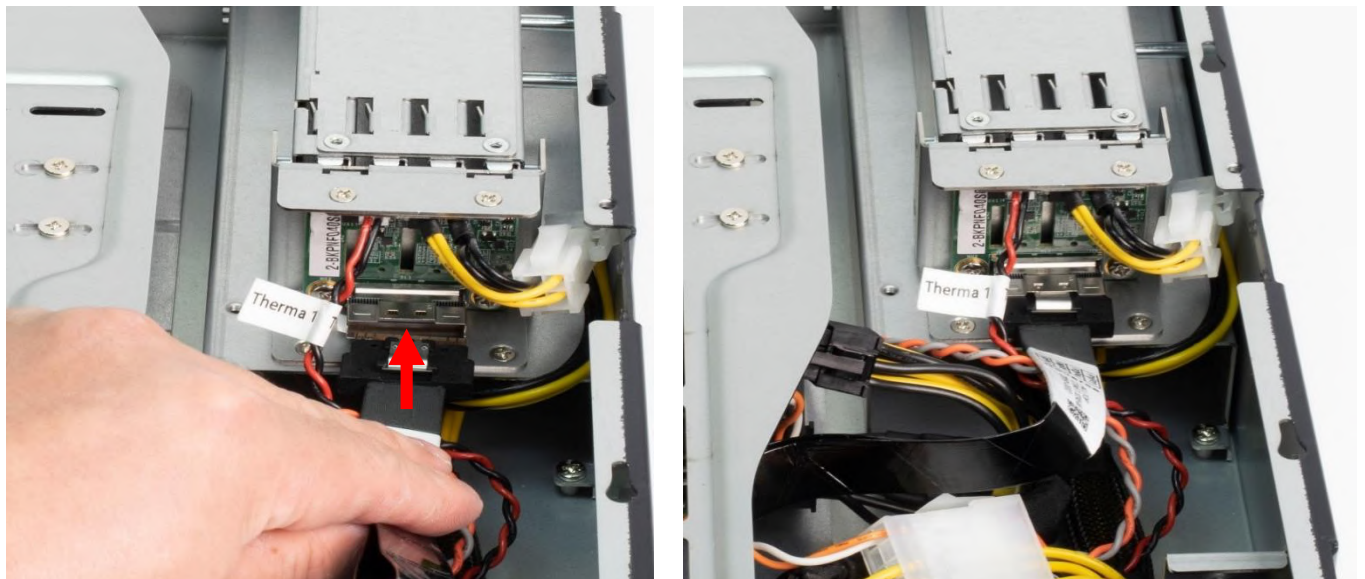

22. Close the chassis cover



3.15 AC Adapter with 3P terminal block

1. 3P Wiring Diagram of AC Adapter

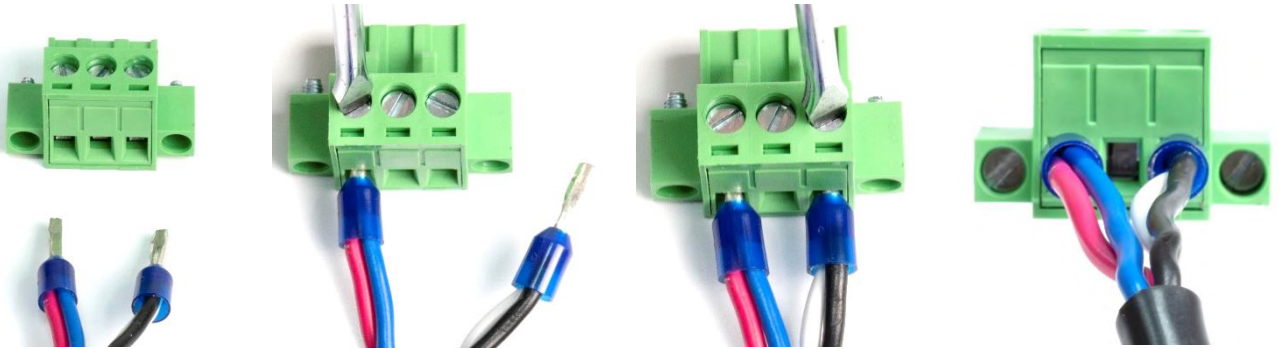

2. DC power input 3P wiring diagram

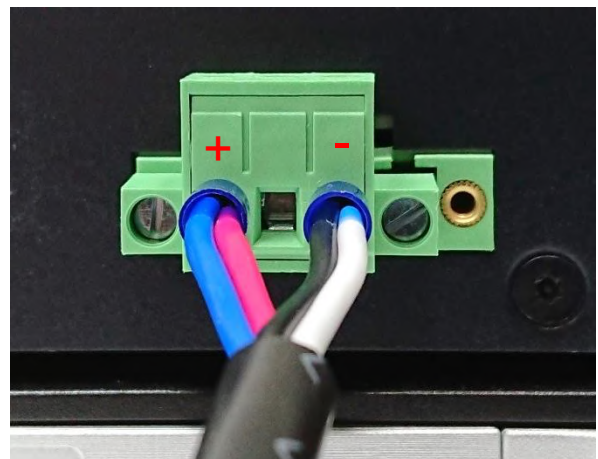
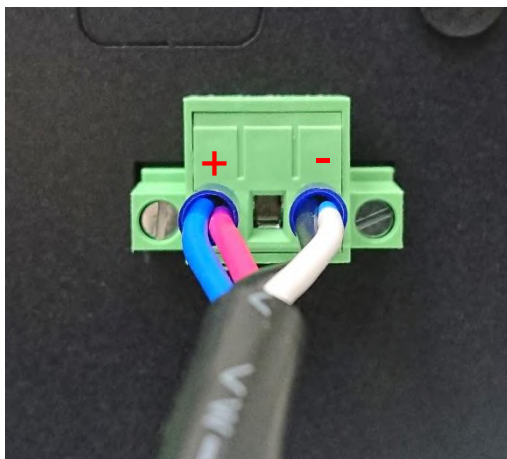
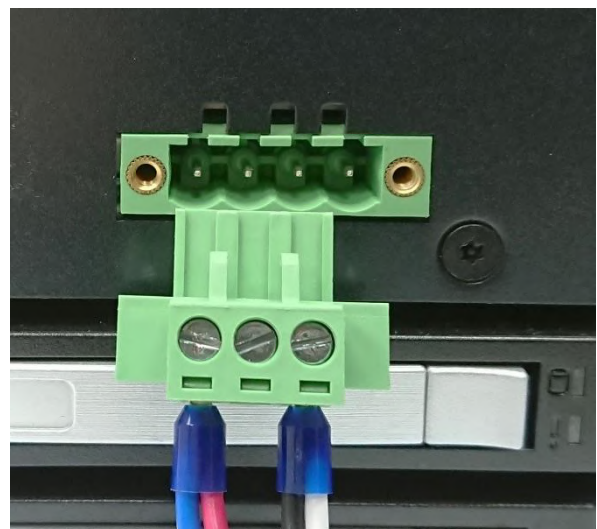
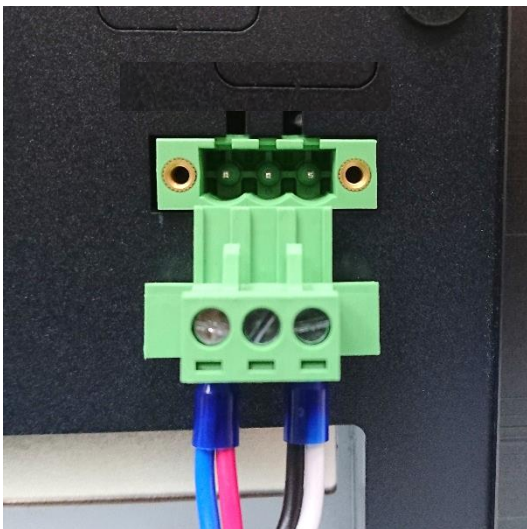

3.16 AC Adapter with 4P terminal block

* 12V requires 4-pin terminal block for card/storage expansion

1. AC adapter 4P wiring diagram

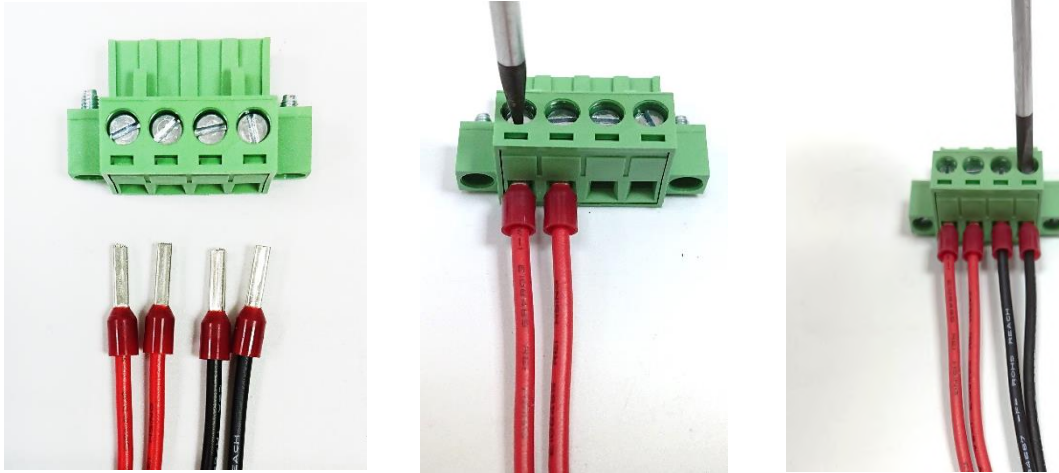

2. DC power input 4P wiring diagram

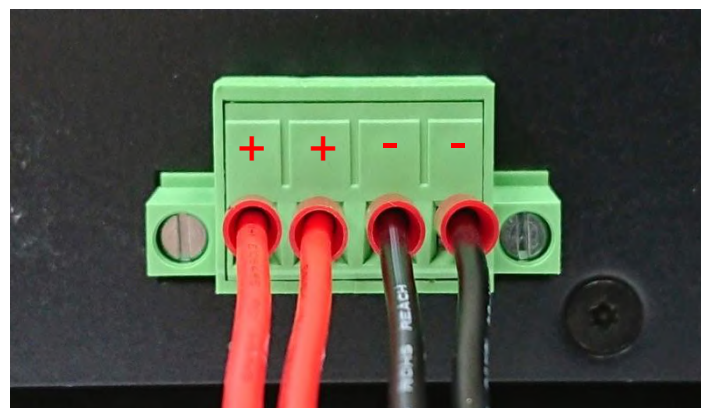
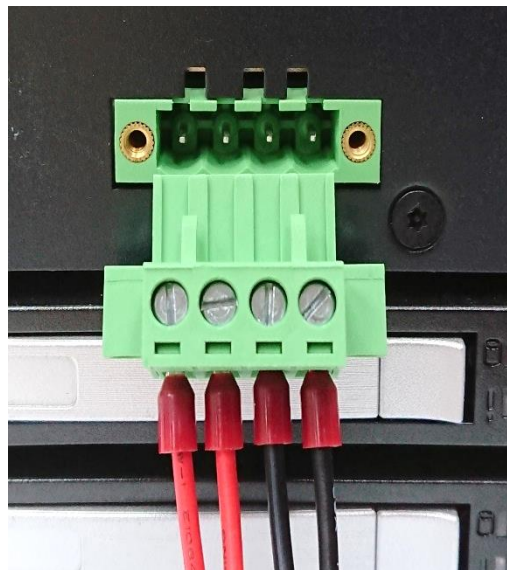

Chapter 4

BIOS Setup

4.1 BIOS Introduction

The BIOS provides an interface to modify the configuration. When the battery is removed, all the parameters will be reset.

BIOS Setup

Power on the embedded system and by pressing immediately allows you to enter the setup screens. If the message disappears before you respond and you still wish to enter the Setup, restart the system by turning it OFF and ON or pressing the RESET button.

You may also restart the system by simultaneously pressing <Ctrl>, <Alt>, and <Delete> keys.

Control Keys	
<→> <←>	Select Screen
<↑> <↓>	Select Item
<Enter>	Select
<Page Up/+>	Increases the numeric value or makes changes
<Page Down/->	Decreases the numeric value or makes changes
<F1>	General Help
<F2>	Previous Value
<F3>	Load Optimized Defaults
<F4>	Save Configuration and Exit
<Tab>	Select Setup Fields
<Esc>	Exit BIOS Setup

Main Setup

The main menu lists the setup functions you can make changes to. You can use the arrow keys (↑↓) to select the item. The on-line description of the highlighted setup function is displayed at the bottom of the screen.

General Help <F1>

The BIOS setup program provides a General Help screen. You can call up this screen from any menu by simply pressing <F1>. The Help screen lists the appropriate keys to use and the possible selections for the highlighted item. Press <Esc> to exit the Help screen.

4.2 Main Setup

Press to enter BIOS CMOS Setup Utility. The Main setup screen is showed as following when the setup utility is entered. System Date/Time is set up in the Main Menu.

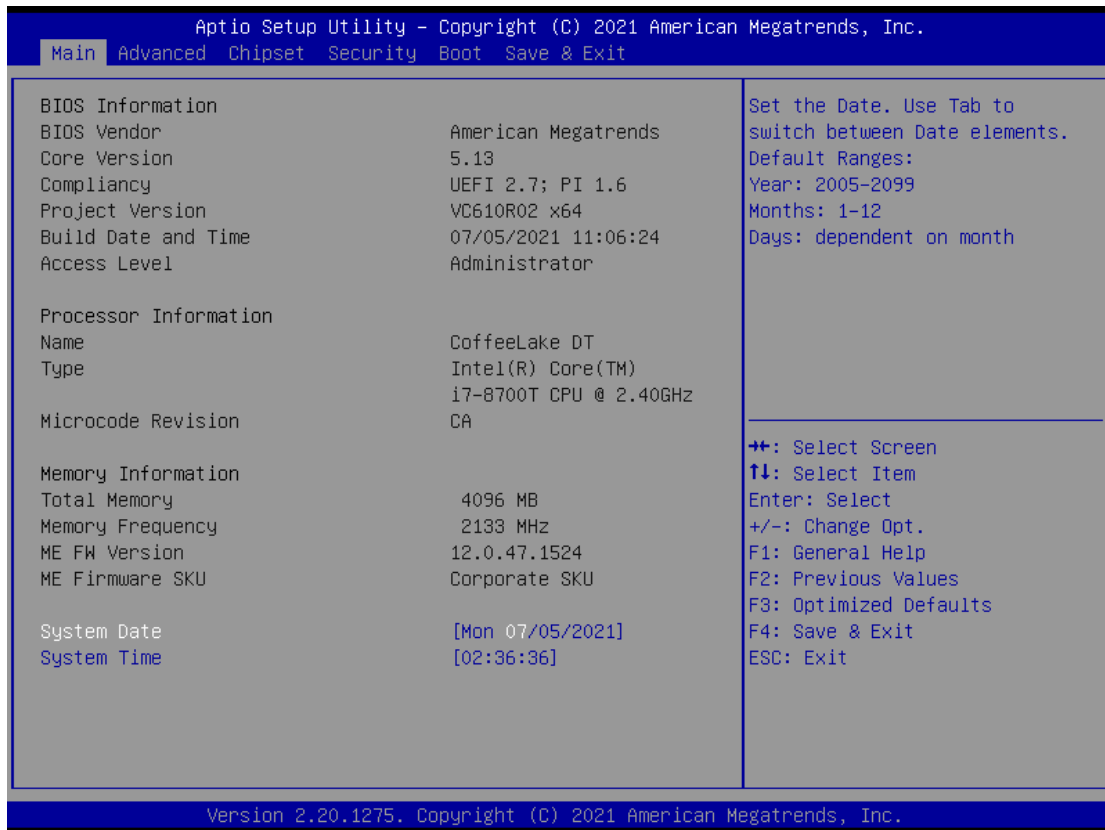

■ System Date

Set the system date. Please use <Tab> to switch between data elements.

■ System Time

Set the system time. Please use <Tab> to switch between time elements.

4.3 Advanced Setup

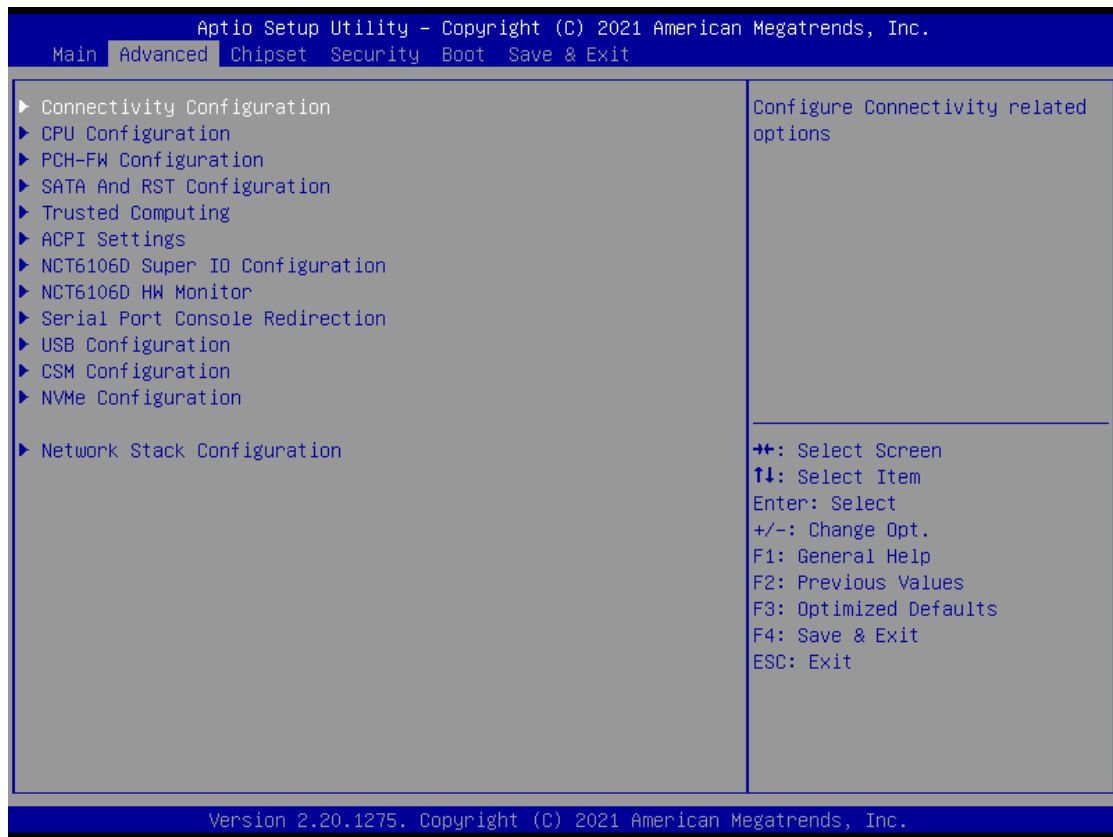

4.3.1 Connectivity Configuration



Item	Options	Description
CNVi Mode	Disable Integrated, Auto Detection [Default]	This option configures Connectivity. [Auto Detection] means that if Discrete solution is discovered it will be enabled by default. Otherwise Integrated solution (CNVi) will be enabled; [Disable Integrated] disables Integrated Solution. NOTE: When CNVi is present, the GPIO pins that are used for radio interface cannot be assigned to the other native function.

4.3.2 CPU Configuration



Item	Options	Description
Intel (VMX) Virtualization Technology	Disabled, Enabled[Default]	When enabled, a VMM can utilize the additional hardware capabilities provided by Virtualization Technology.
Active Processor Cores	All[Default] 1 2 3	Number of cores to enable in each processor package.
Hyper-Threading	Disabled, Enabled[Default]	Enabled for Windows XP and Linux (OS optimized for Hyper-Threading Technology) and Disabled for other OS (OS not optimized for Hyper-Threading Technology).
Intel SpeedStep	Disabled, Enabled[Default]	This item allows you to enable or disable the Intel SpeedStep.
Turbo Mode	Disabled, Enabled[Default]	This item allows you to enable or disable the Turbo Mode.
C states	Disabled, Enabled[Default]	Enable/Disable CPU Power Management. Allows CPU to go to C states when it's not 100% utilized.

4.3.3 PCH-FW Configuration

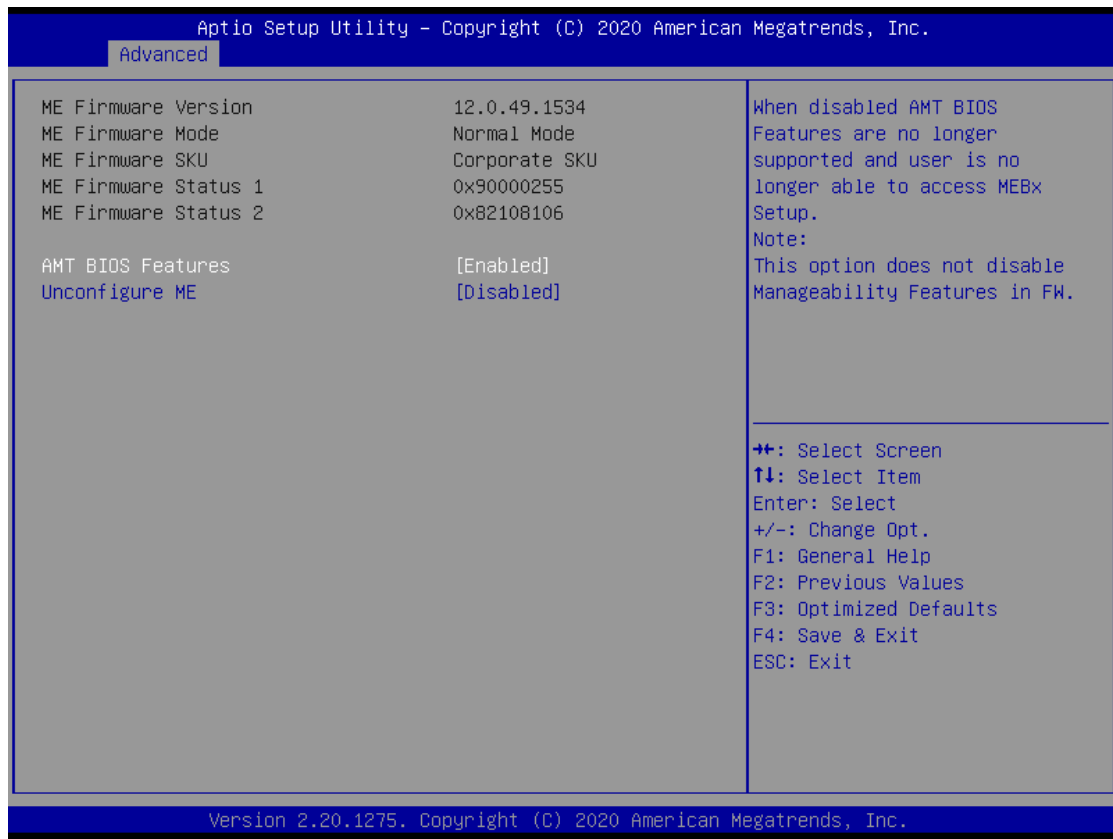

Item	Options	Description
AMT BIOS Features	Disabled, Enabled [Default]	When disabled AMT BIOS Features are no longer supported and user is no longer able to access MEBx Setup. Note: This option does not disable Manageability Features in FW.
Unconfigure ME	Disabled [Default] , Enabled	OEMFlag Bit 15: Unconfigure ME with resetting MEBx password to default.

4.3.4 SATA and RST Configuration

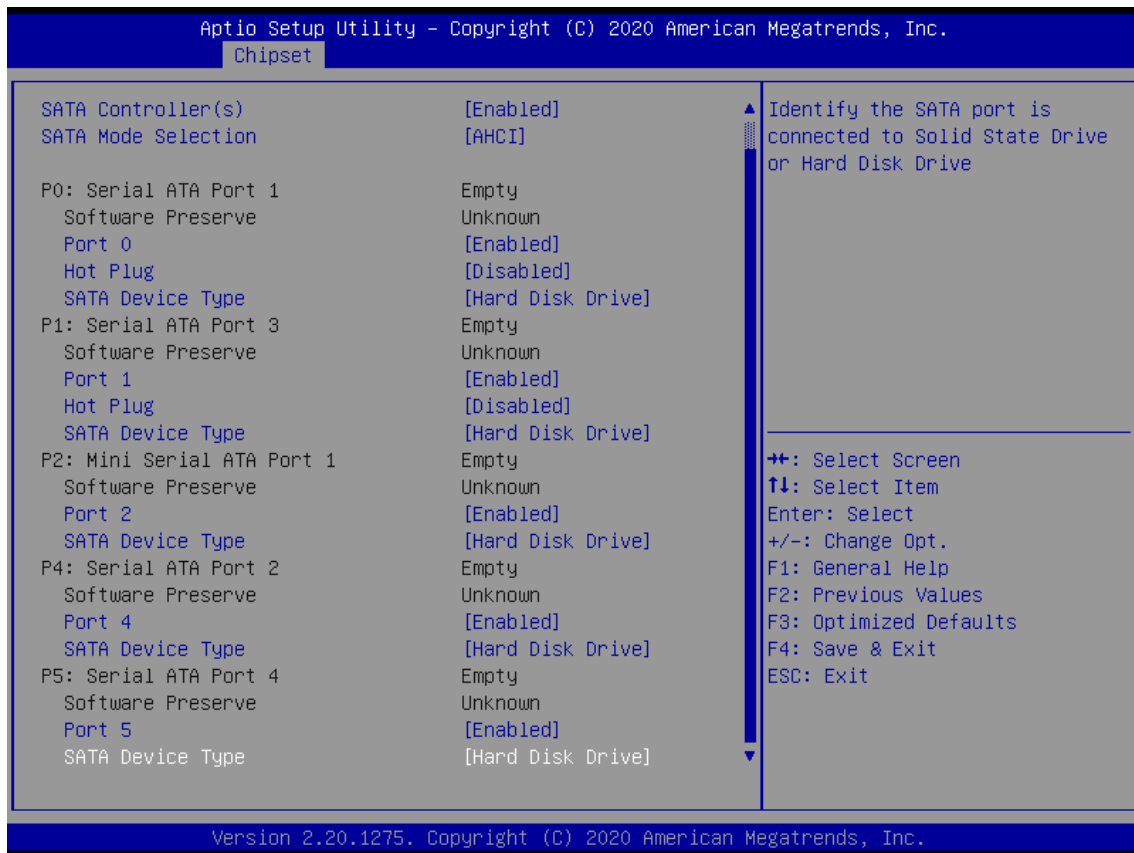

Item	Options	Description
SATA Controller(s)	Disabled, Enabled[Default]	Enable/Disable SATA Device.
SATA Mode Selection	AHCI[Default] , Intel RST Premium With Intel Optane System Acceleration	Determines how SATA controller(s) operate.
Use RST Legacy OROM	Disabled[Default] , Enabled	Use RST Legacy OROM when CSM is Enabled. Note: When you see the POST screen, Please press <CTRL-I> to into Legacy RAID setting interface.
Port1 ~5	Disabled, Enabled[Default]	Enable/Disable SATA Port.
SATA Device Type	Hard Disk Drive Solid State Drive[Default]	Identify the SATA port is connected to Solid State Drive or Hard Disk Drive.
Hot Plug	Disabled, Enabled[Default]	Designates this port as Hot Pluggable.

4.3.5 RST (UEFI RAID) Configuration

How to set the UEFI RAID:

1. When set to "Intel RST Premium With Intel Optane System Acceleration", please save change reset system.

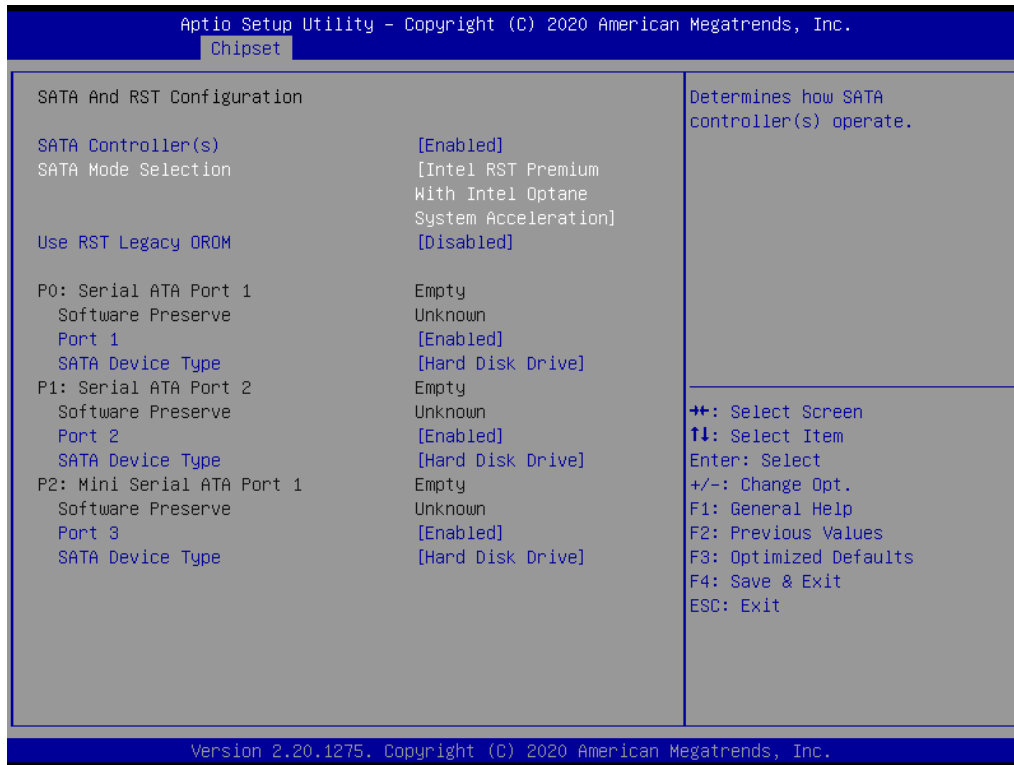

2. After reboot the system, please into BIOS utility and then will see "Intel (R) Rapid Storage Technology"

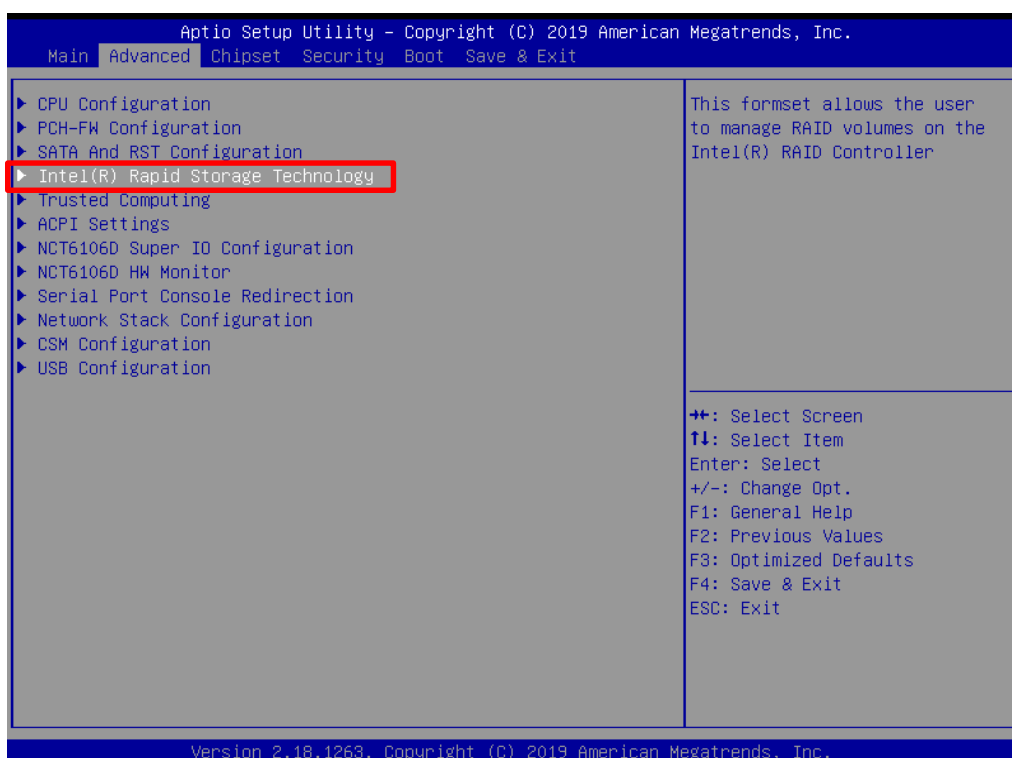

3. Into Intel(R) Rapid Storage Technology, and start create RAID volume.

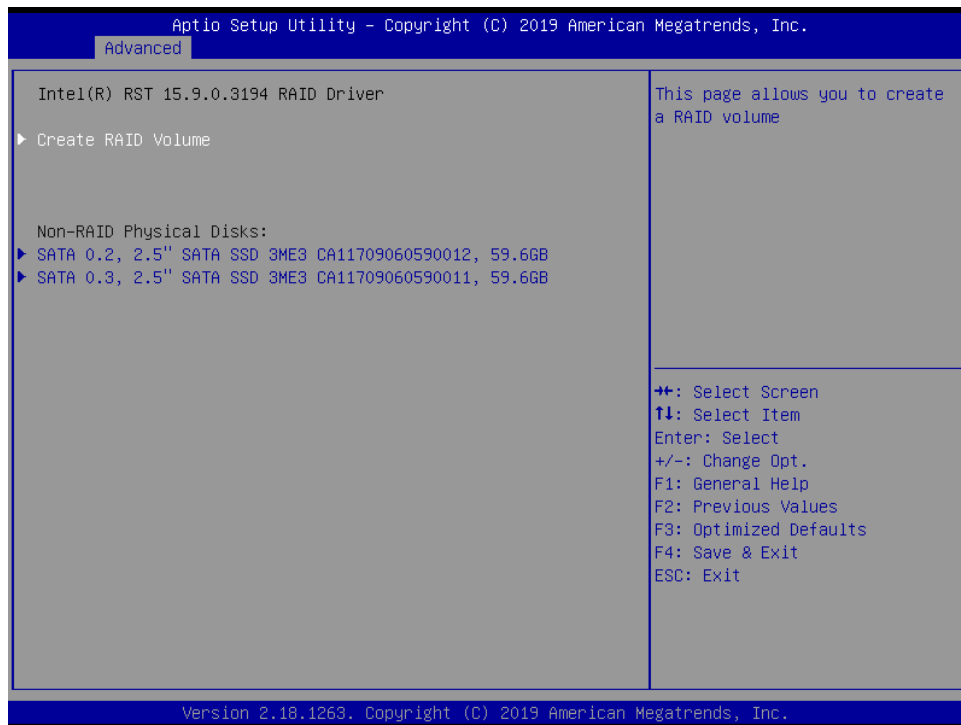

4. Start Create the RAID

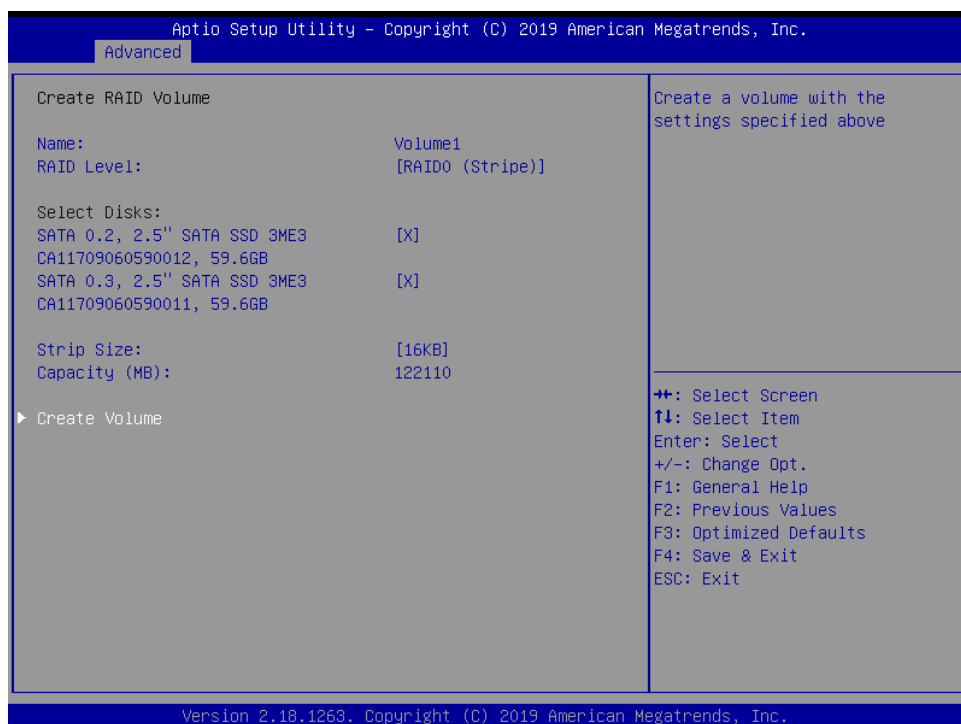

- Select Disk that you want to do the RAID
- Select [x]; No-Select []

4.3.6 Trusted Computing



Item	Options	Description
Security Device Support	Enabled, Disabled[Default] ,	Enable/Disable BIOS support for security device. O.S. will not show Security Device.TCG EFI protocol and INT1A interface will not be available.
Pending operation	None[Default] , TPM Clear	Schedule an Operation for the Security Device. NOTE: Your Computer will reboot during restart in order to change State of Security Device.

4.3.7 ACPI Settings

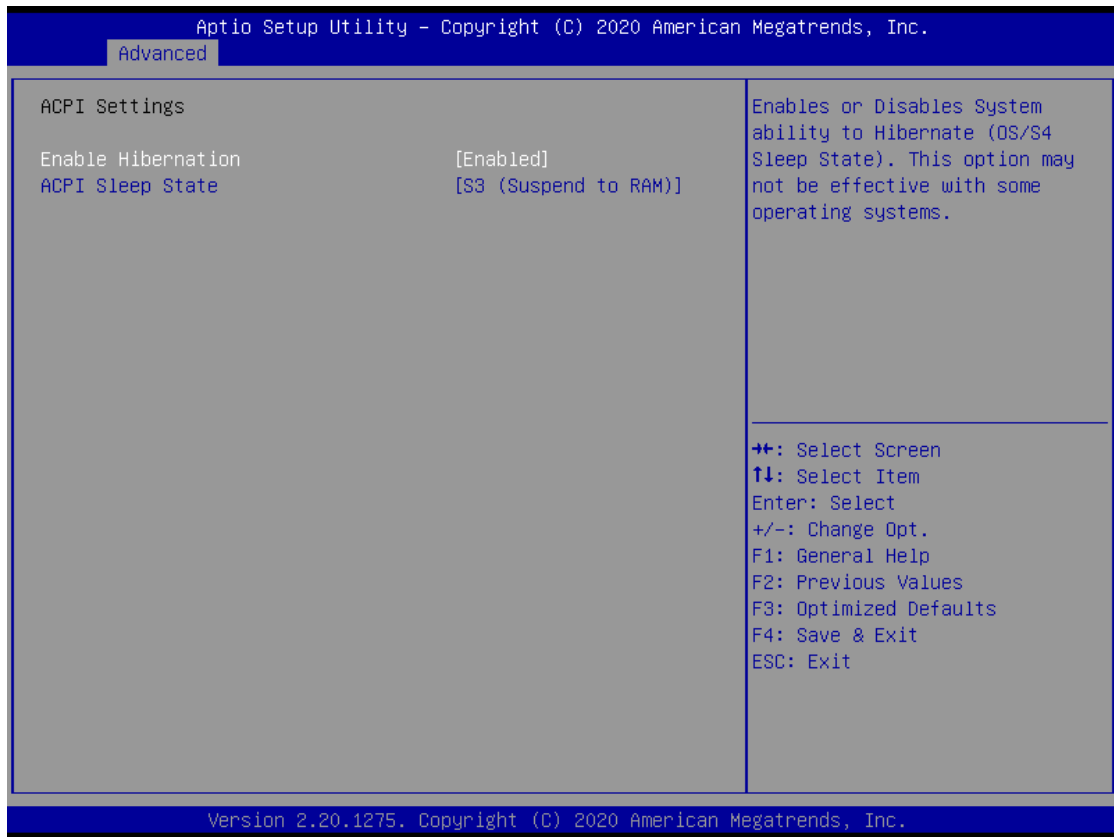

Item	Options	Description
Enable Hibernation	Disabled , Enabled [Default] ,	Enables or Disables System ability to Hibernate (OS/S4 Sleep State). This option may not be effective with some operating systems.
ACPI Sleep State	Suspend Disabled, S3 (Suspend to RAM) [Default]	Select the highest ACPI sleep state the system will enter when the SUSPEDN button is pressed.

4.3.8 Super IO Configuration

This setting allows you to select options for the Super IO Configuration, and change the value of the selected option.

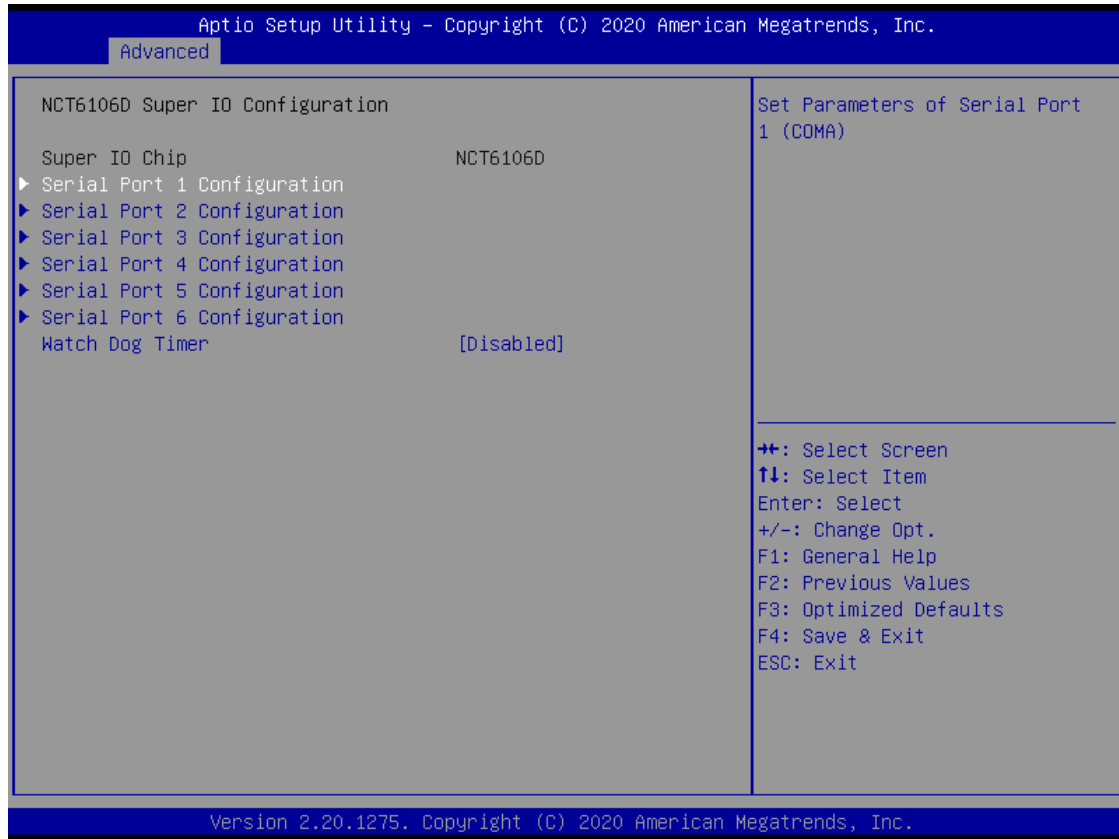

Item	Description
Serial Port 1 Configuration	Set Parameters of Serial Port 1 (COMA).
Serial Port 2 Configuration	Set Parameters of Serial Port 2 (COMB).
Serial Port 3 Configuration	Set Parameters of Serial Port 3 (COMC).
Serial Port 4 Configuration	Set Parameters of Serial Port 4 (COMD).
Serial Port 5 Configuration	Set Parameters of Serial Port 5 (COME).
Serial Port 6 Configuration	Set Parameters of Serial Port 6 (COMF).

Item	Options	Description
Watch Dog Timer	Disabled [Default] , Enabled	Enabled or Disabled Watch Dog Timer function.
Watch Dog Timer Count Mode	Second Mode [Default] , Minute Mode	Select Second Mode or Minute Mode.
Watch Dog Timer Time out Value	20~255(Second) [Default] , 1~255(Minute)	Watch Dog Timer Time out Value.

Serial Port 1 Configuration

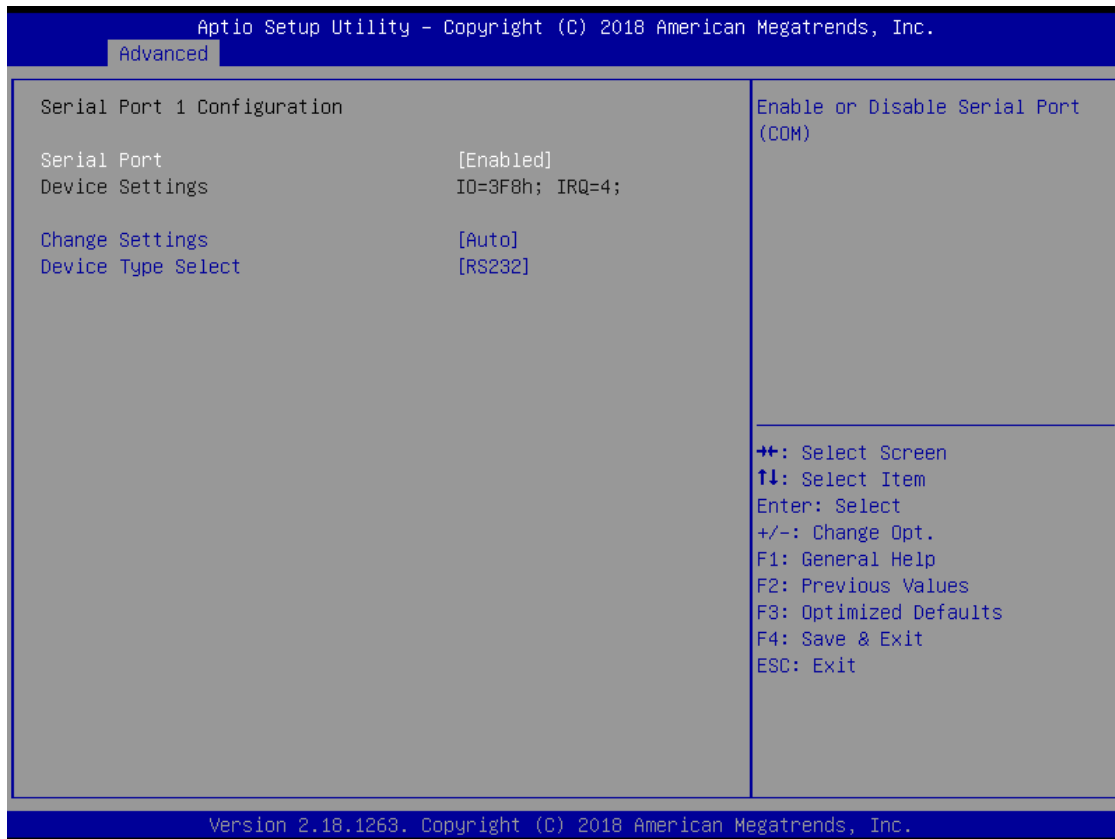

Item	Options	Description
Serial Port	Disabled, Enabled[Default]	Enable or Disable Serial Port (COM).
Change Settings	Auto[Default], IO=3F8h; IRQ=4; , IO=3F8h; IRQ=3,4,5,6,7,9,10,11,12; , IO=2F8h; IRQ=3,4,5,6,7,9,10,11,12;; IO=3E8h; IRQ=3,4,5,6,7,9,10,11,12;; IO=2E8h; IRQ=3,4,5,6,7,9,10,11,12;	This item allows you to change the address & IRQ settings of the specified serial port.
Device Type Select	UART 232[Default], UART 422, UART 485	Set the Serial Port to RS232 & RS422 & RS485

Serial Port 2 Configuration

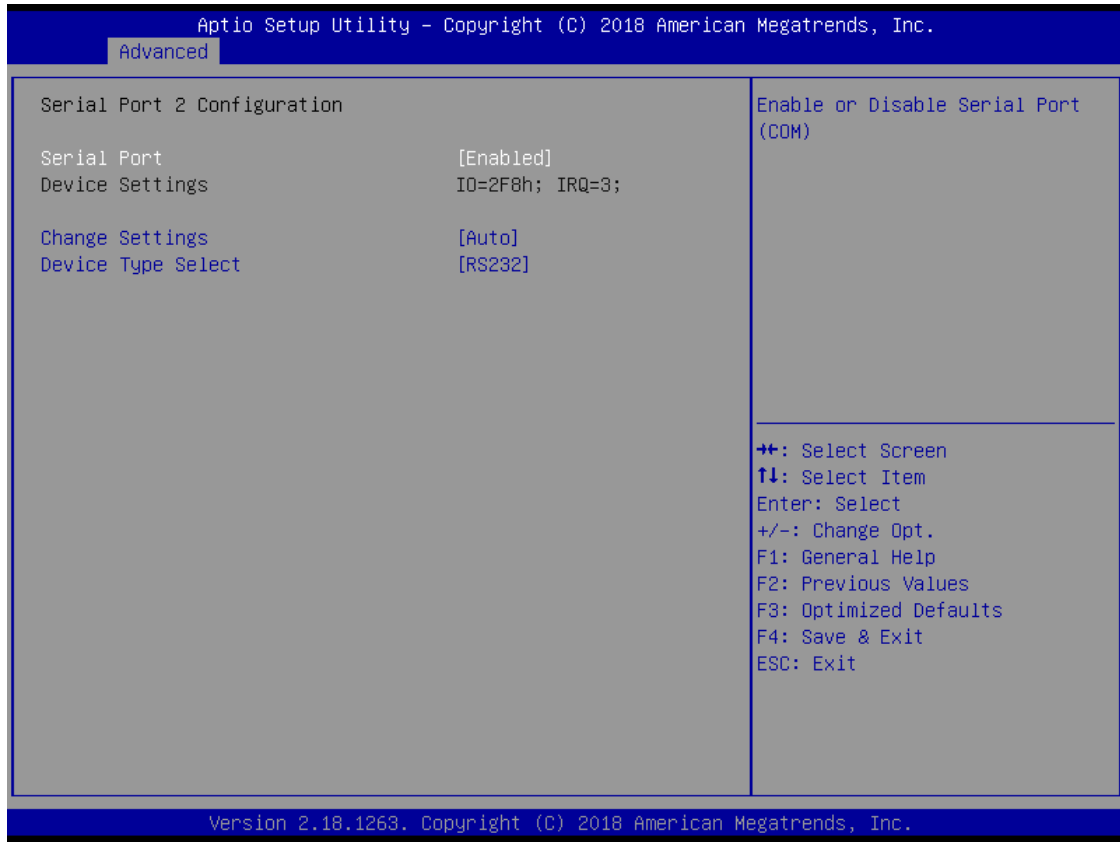

Item	Options	Description
Serial Port	Disabled, Enabled[Default]	Enable or Disable Serial Port (COM).
Change Settings	Auto[Default], IO=2F8h; IRQ=3; , IO=3F8h; IRQ=3,4,5,6,7,9,10,11,12; , IO=2F8h; IRQ=3,4,5,6,7,9,10,11,12;; IO=3E8h; IRQ=3,4,5,6,7,9,10,11,12;; IO=2E8h; IRQ=3,4,5,6,7,9,10,11,12;	This item allows you to change the address & IRQ settings of the specified serial port.
Device Type Select	UART 232[Default], UART 422, UART 485	Set the Serial Port to RS232 & RS422 & RS485

■ Serial Port 3 Configuration

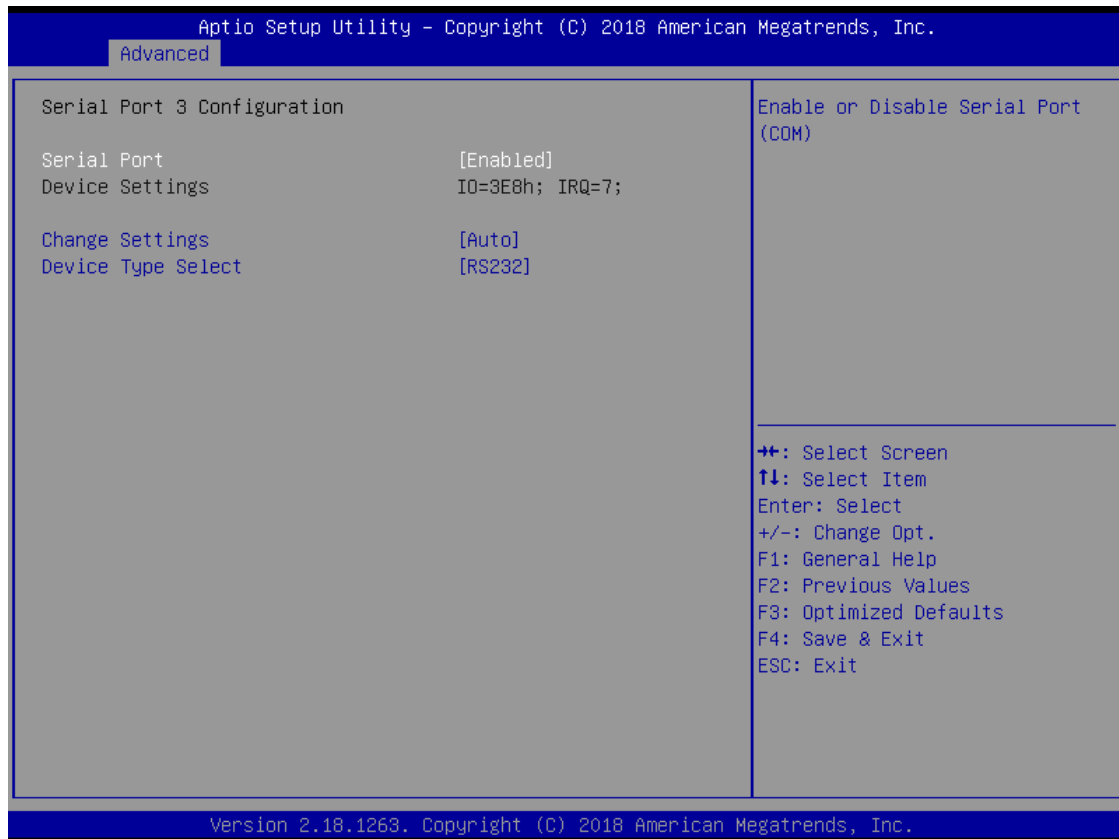

Item	Options	Description
Serial Port	Disabled, Enabled[Default]	Enable or Disable Serial Port (COM).
Change Settings	Auto[Default], IO=3E8h; IRQ=7; , IO=3E8h; IRQ=3,4,5,6,7,9,10,11,12; , IO=2E8h; IRQ=3,4,5,6,7,9,10,11,12;; IO=2F0h; IRQ=3,4,5,6,7,9,10,11,12;; IO=2E0h; IRQ=3,4,5,6,7,9,10,11,12;	This item allows you to change the address & IRQ settings of the specified serial port.
Device Type Select	UART 232[Default], UART 422, UART 485	Set the Serial Port to RS232 & RS422 & RS485

Serial Port 4 Configuration

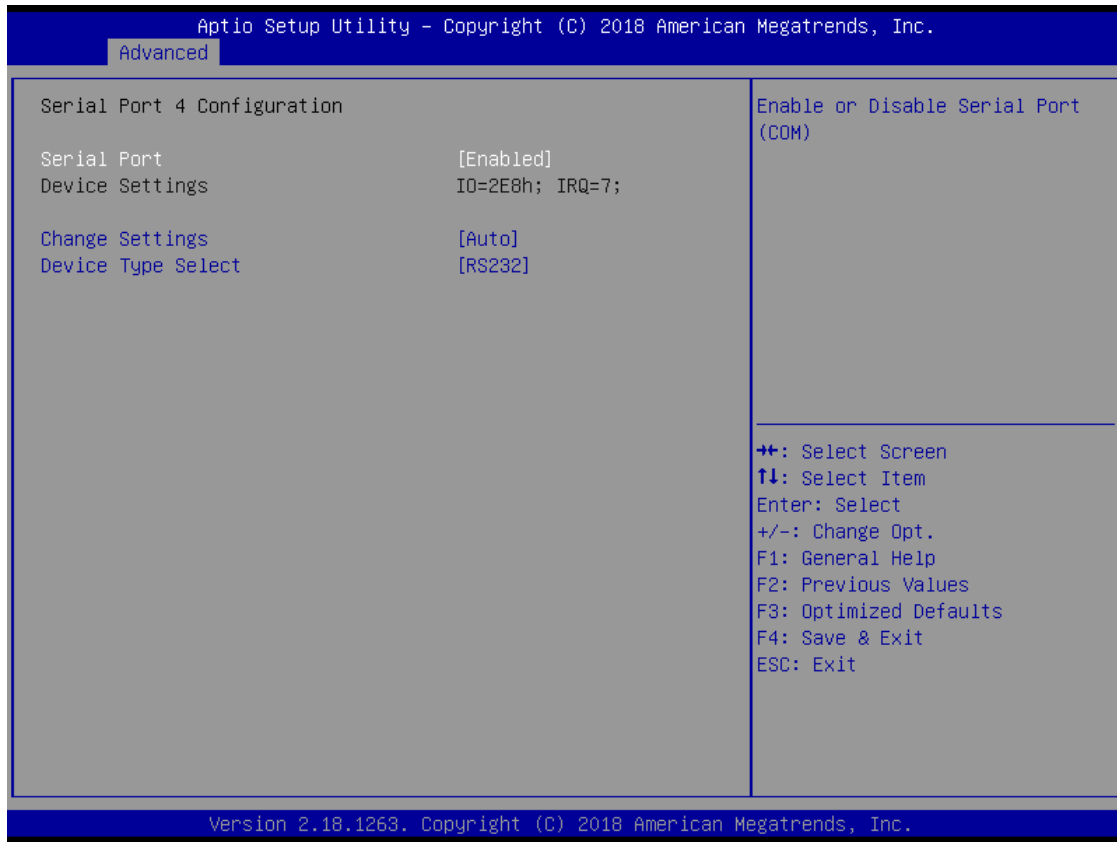

Item	Options	Description
Serial Port	Disabled, Enabled[Default]	Enable or Disable Serial Port (COM).
Change Settings	Auto[Default], IO=2E8h; IRQ=7; , IO=3E8h; IRQ=3,4,5,6,7,9,10,11,12; , IO=2E8h; IRQ=3,4,5,6,7,9,10,11,12;; IO=2F0h; IRQ=3,4,5,6,7,9,10,11,12;; IO=2E0h; IRQ=3,4,5,6,7,9,10,11,12;	This item allows you to change the address & IRQ settings of the specified serial port.
Device Type Select	UART 232[Default], UART 422, UART 485	Set the Serial Port to RS232 & RS422 & RS485

Serial Port 5 Configuration

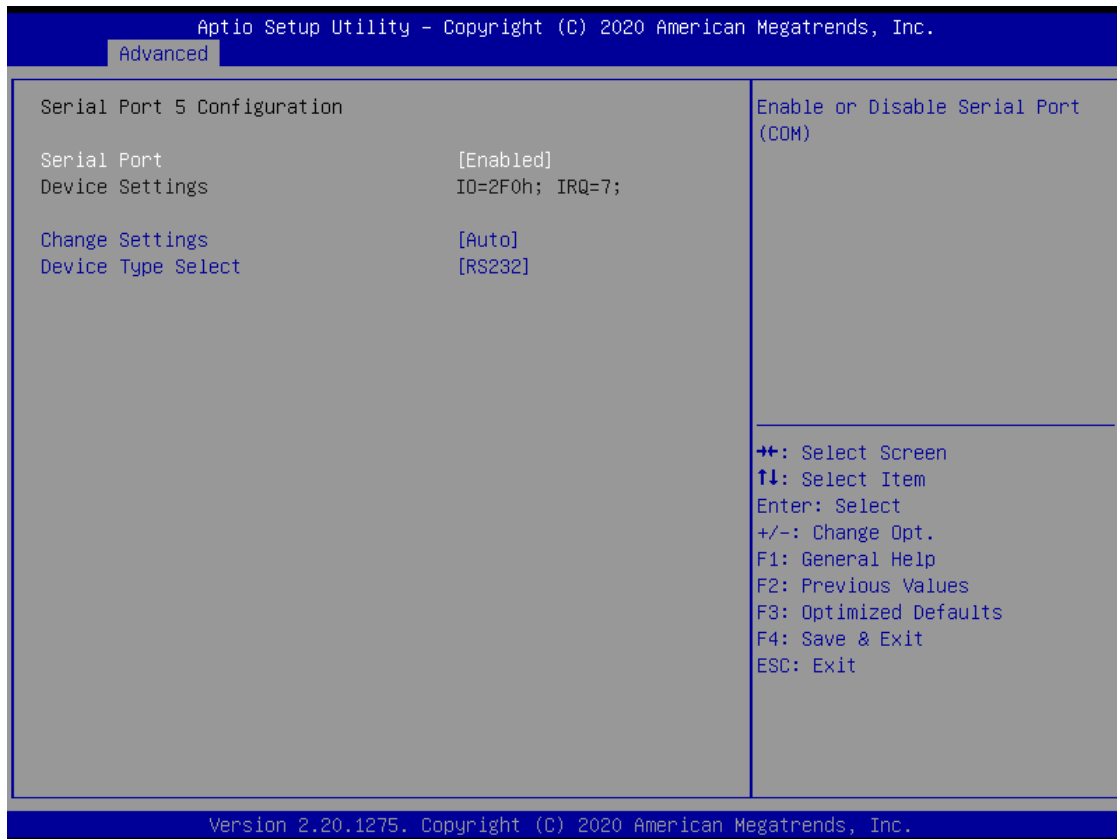

Item	Options	Description
Serial Port	Disabled, Enabled[Default]	Enable or Disable Serial Port (COM).
Change Settings	Auto[Default], IO=2F0h; IRQ=7; , IO=2E8h; IRQ=3,4,5,6,7,9,10,11,12; , IO=2E8h; IRQ=3,4,5,6,7,9,10,11,12;; IO=2F0h; IRQ=3,4,5,6,7,9,10,11,12;; IO=2E0h; IRQ=3,4,5,6,7,9,10,11,12;	This item allows you to change the address & IRQ settings of the specified serial port.
Device Type Select	UART 232[Default], UART 422, UART 485	Set the Serial Port to RS232 & RS422 & RS485

Serial Port 6 Configuration

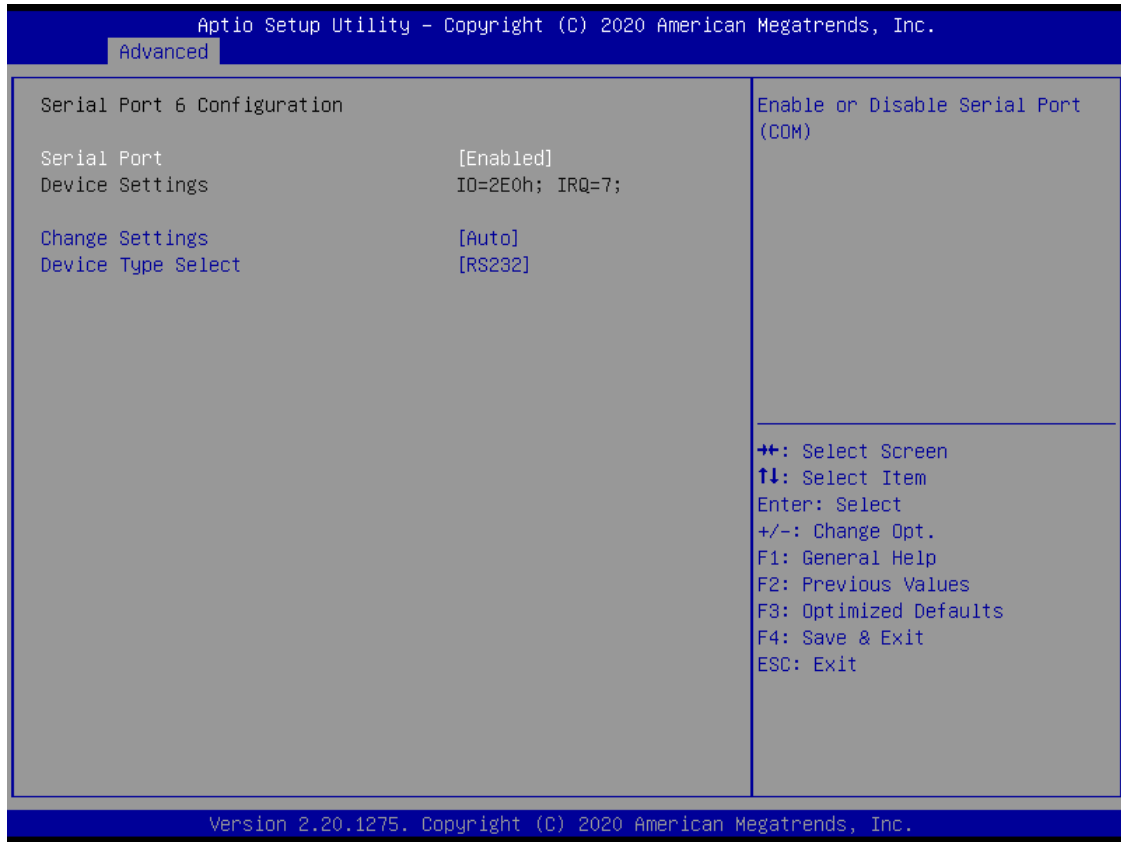

Item	Options	Description
Serial Port	Disabled, Enabled[Default]	Enable or Disable Serial Port (COM).
Change Settings	Auto[Default], IO=2E0h; IRQ=7; , IO=3E8h; IRQ=3,4,5,6,7,9,10,11,12; , IO=2E8h; IRQ=3,4,5,6,7,9,10,11,12,, IO=2F0h; IRQ=3,4,5,6,7,9,10,11,12,, IO=2E0h; IRQ=3,4,5,6,7,9,10,11,12;	This item allows you to change the address & IRQ settings of the specified serial port.
Device Type Select	UART 232[Default], UART 422, UART 485	Set the Serial Port to RS232 & RS422 & RS485

4.3.9 Hardware Monitor

These items display the current status of all monitored hardware devices/ components such as voltages and temperatures.

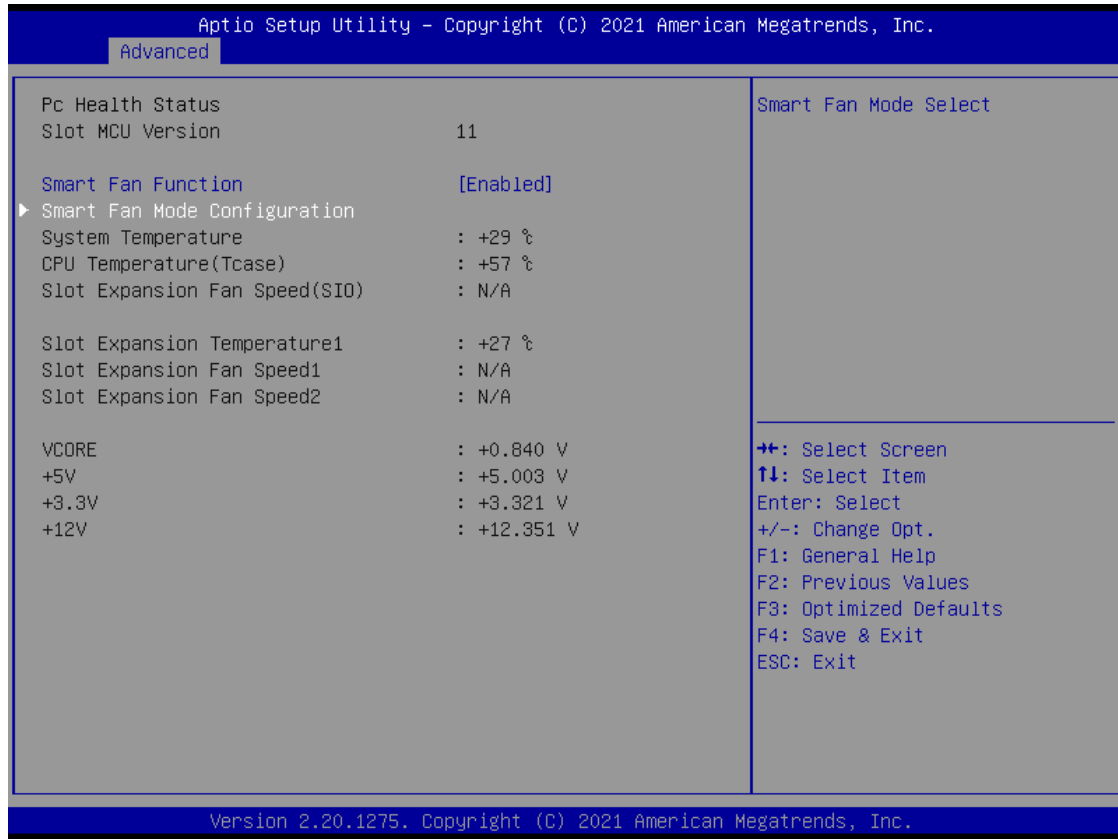

Item	Options	Description
Smart Fan Function	Disabled[Default], Enabled	Enabled or Disable Smart Fan

Smart Fan Mode Configuration

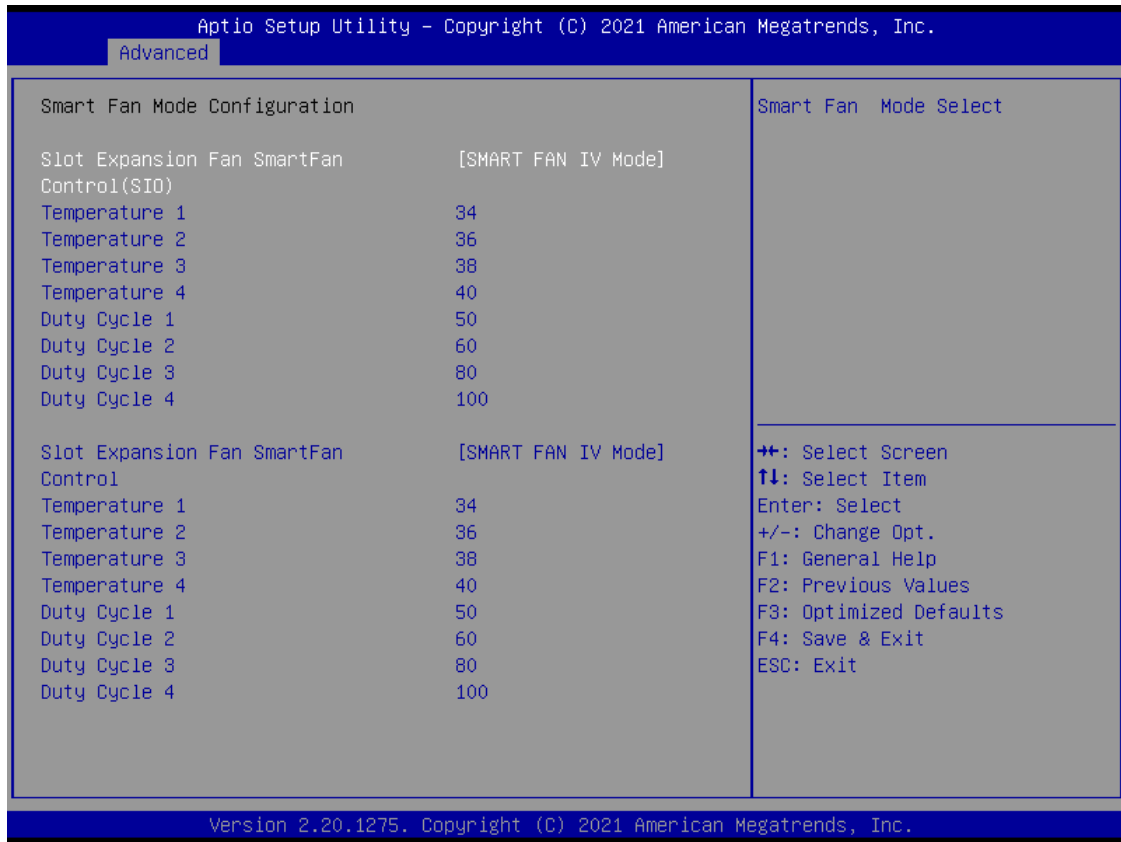

Item	Options	Description
Expansion Fan SmartFan Control	Manual Mode, SMART FAN IV Mode[Default],	Smart Fan Mode Select
Temperature 1~4	1~100	Auto fan speed control. SMART FAN IV
Duty Cycle 1~4	20~100	Auto fan speed control. SMART FAN IV

4.3.10 Serial Port Console Redirection

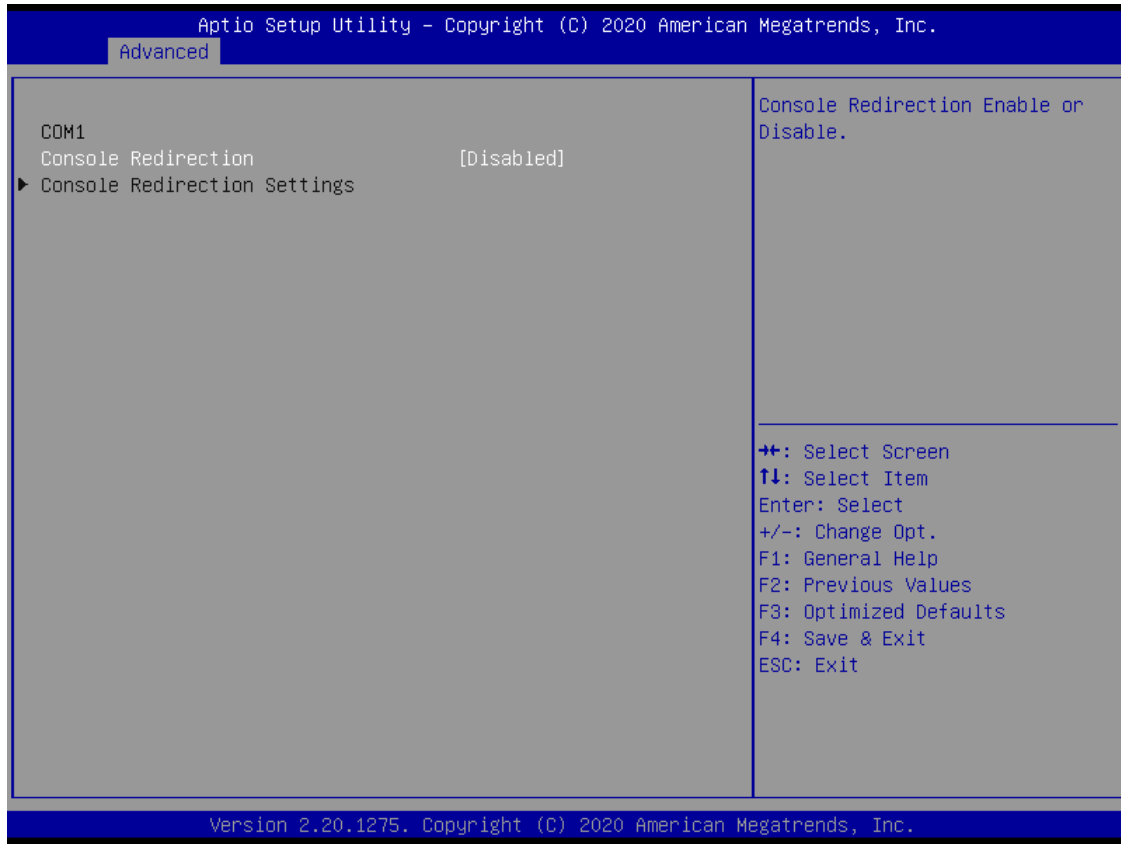

Item	Options	Description
Console Redirection	Disabled[Default], Enabled	These items allows you to enable or disable COM1 console redirection

4.3.11 Network Stack Configuration



Item	Options	Description
Network Stack	Disabled[Default] , Enabled	Enable/Disable UEFI Network Stack.

4.3.12 CSM Configuration

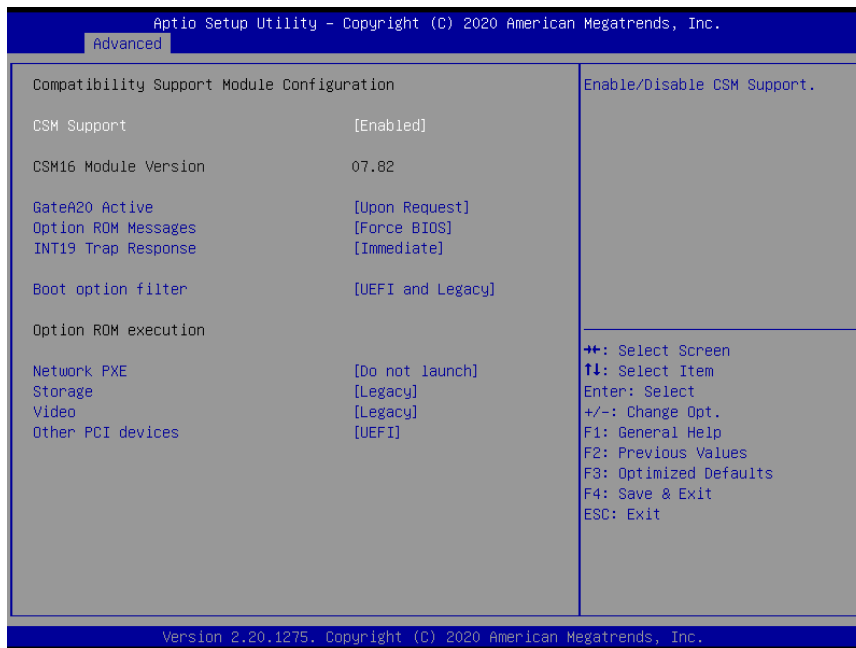

Item	Options	Description
CSM Support	Disabled, Enabled[Default]	This item allows users to enable or disable for "CSM Support".
GateA20 Active	Upon Request[Default], Always	This item allows users to set Upon Request or Always for "GateA20 Active".
Option ROM Messages	Force BIOS[Default], Keep Current	This item allows users to set Force BIOS or Keep Current for "Option ROM Messages".
INT19 Trap Response	Immediate[Default], Immediate	This item allows users to set the BIOS reaction to INT19 trapping by Option ROM: "Immediate" - execute the trap right away; "postponed" - execute the trap during legacy boot.
Boot option filter	UEFI and Legacy[Default], Legacy only, UEFI only	This item allows users to select which type of operating system to boot by option. This item is configurable only when CSM Support is set to Enabled.
Network PXE	Do not launch[Default], UEFI, Legacy	Controls the execution of UEFI and Legacy Video OpROM.
Storage	Do not launch, UEFI, Legacy[Default]	Controls the execution of UEFI and Legacy Storage OpROM.
Video	Do not launch, UEFI, Legacy[Default]	Controls the execution of UEFI and Legacy Video OpROM.
Other PCI devices	Do not launch, UEFI[Default], Legacy	Determines OpROM execution policy for devices other than Network, Storage, or Video.

4.3.13 USB Configuration

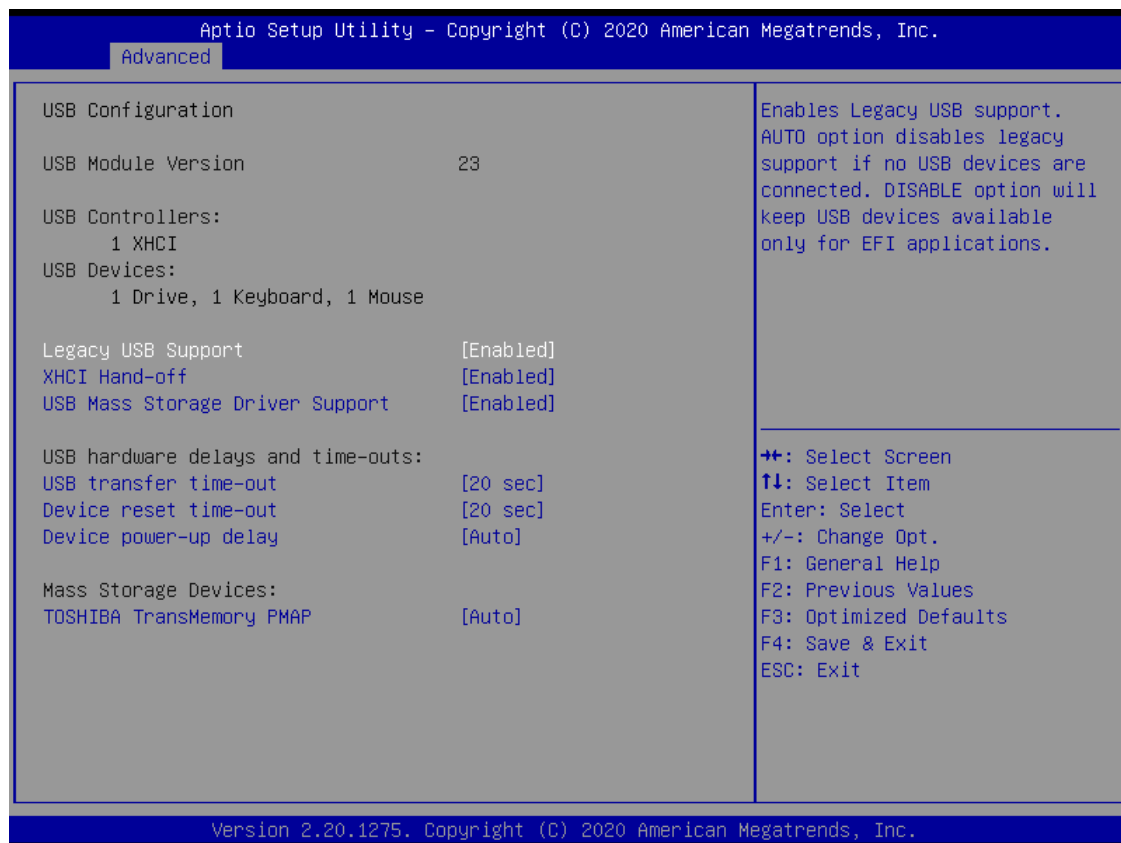

Item	Options	Description
Legacy USB Support	Enabled[Default] Disabled Auto	Enables Legacy USB support. AUTO option disables legacy support if no USB devices are connected. DISABLE option will keep USB devices available only for EFI applications.
XHCI Hand-off	Enabled[Default] Disabled	This is a workaround for OSes without XHCI hand-off support. The XHCI ownership change should be claimed by XHCI driver.
USB Mass Storage Driver Support	Enabled[Default] Disabled	Enable/Disable USB Mass Storage Driver Support.
USB transfer time-out	1 sec , 5 sec , 10 sec , 20 sec[Default]	The time-out value for Control, Bulk, and Interrupt transfers.
Device reset time-out	10 sec , 20 sec[Default] , 30 sec , 40 sec	USB mass storage device Start Unit command time-out.
Device power-up delay	Auto[Default] Manual	Maximum time the device will take before it properly reports itself to the Host Controller. 'Auto' uses default value: for a Root port it is 100ms, for a Hub port the delay is taken from Hub descriptor.

4.4 Chipset

This section allows you to configure and improve your system and allows you to set up some system features according to your preference.



4.4.1 System Agent (SA) Configuration



■ Memory Configuration

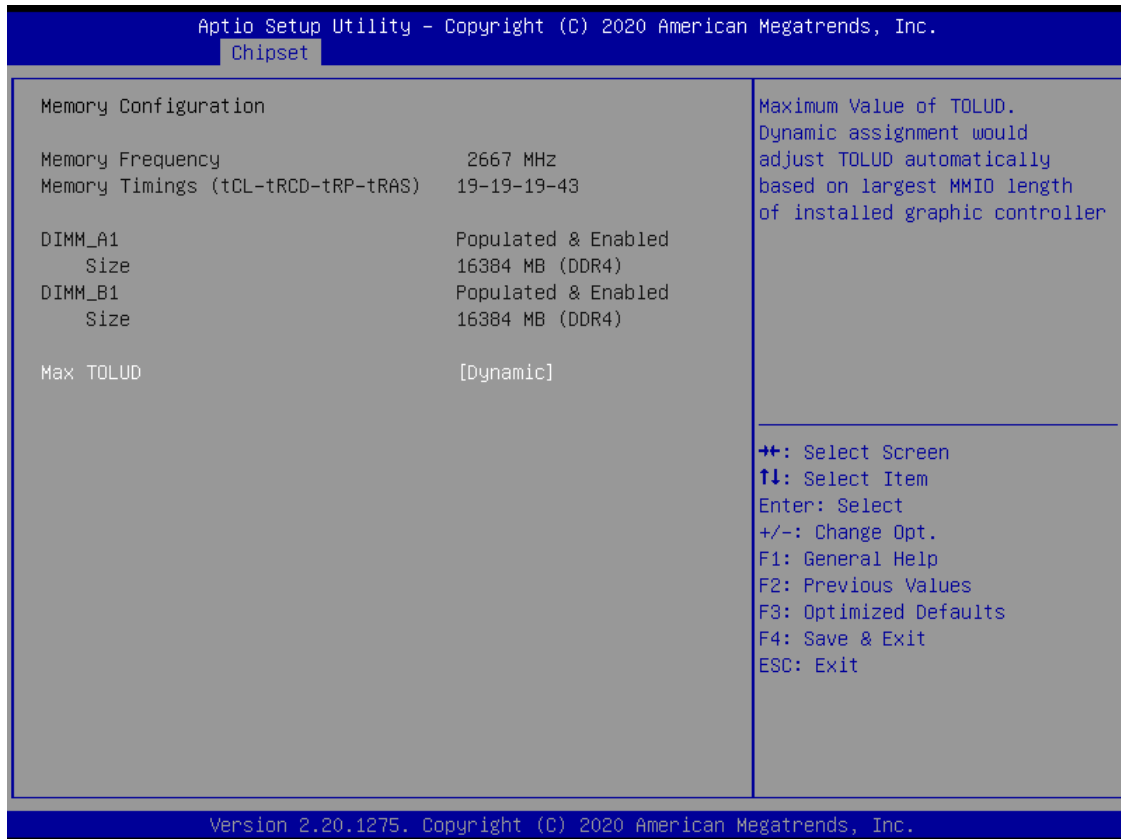

Item	Options	Description
Max TOLUD	Dynamic[Default], 1GB, 1.25GB, 1.5 GB, 1.75 GB, 2 GB, 2.25 GB, 2.5 GB, 2.75 GB, 3 GB, 3.25 GB, 3.5 GB	Maximum Value of TOLUD. Dynamic assignment would adjust TOLUD automatically based on largest MMIO length of installed graphic controller

■ Graphic Configuration

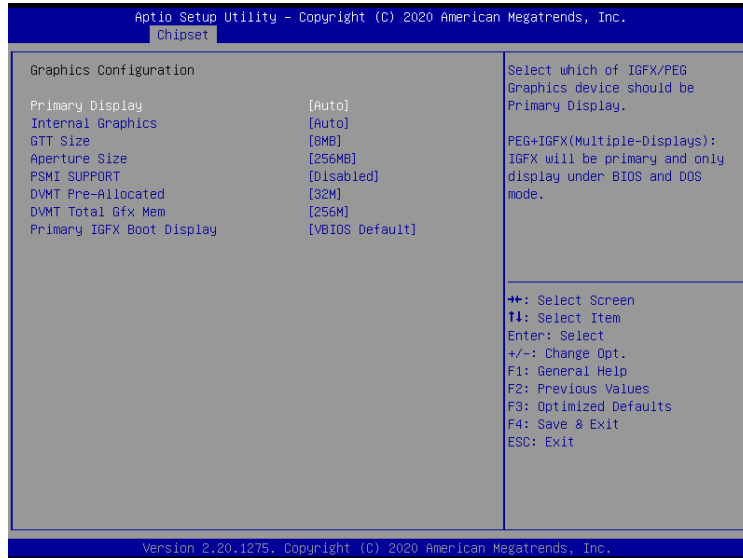

Item	Options	Description
Primary Display	Auto[Default] , PEG + IGFX	Select which of IGFX/PEG Graphics device should be Primary Display. PEG+IGFX(Multiple-Displays): IGFX will be primary and only display under BIOS and DOS mode.
Internal Graphics	Auto[Default] , Disabled, Enabled	Keep IGFX enabled based on the setup options.
GTT Size	2MB, 4MB, 8MB[Default]	Select the GTT Size .
Aperture Size	128MB, 256MB[Default] , 512MB, 1024MB, 2048MB	Select the Aperture Size. Note : Above 4GB MMIO BIOS assignment is automatically enabled when selecting 2048MB aperture. To use this feature, please disable CSM Support.
PSMI SUPPORT	Disabled [Default] , Enabled	PSMI Enable/Disable.
DVMT Pre-Allocated	32M [Default] , 64M,4M,8M, 12M,16M, 20M, 24M, 28M,32M/F7, 36M, 40M,44M, 48M,52M,56M,60M	Select DVMT 5.0 Pre-Allocated (Fixed) Graphics Memory size used by the Internal Graphics Device.
DVMT Total Gfx Mem	128M, 256M[Default] , MAX	Select DVMT5.0 Total Graphic Memory size used by the Internal Graphics Device.
Primary IGFX Boot Display	VBIOS Default[Default] , DP1, CRT, DVI, DP2	Select the Video Device which will be activated during POST. This has no effect if external graphics present. Secondary boot display selection will appear based on your selection.VGA modes will be supported only on primary display

■ PEG Port Configuration

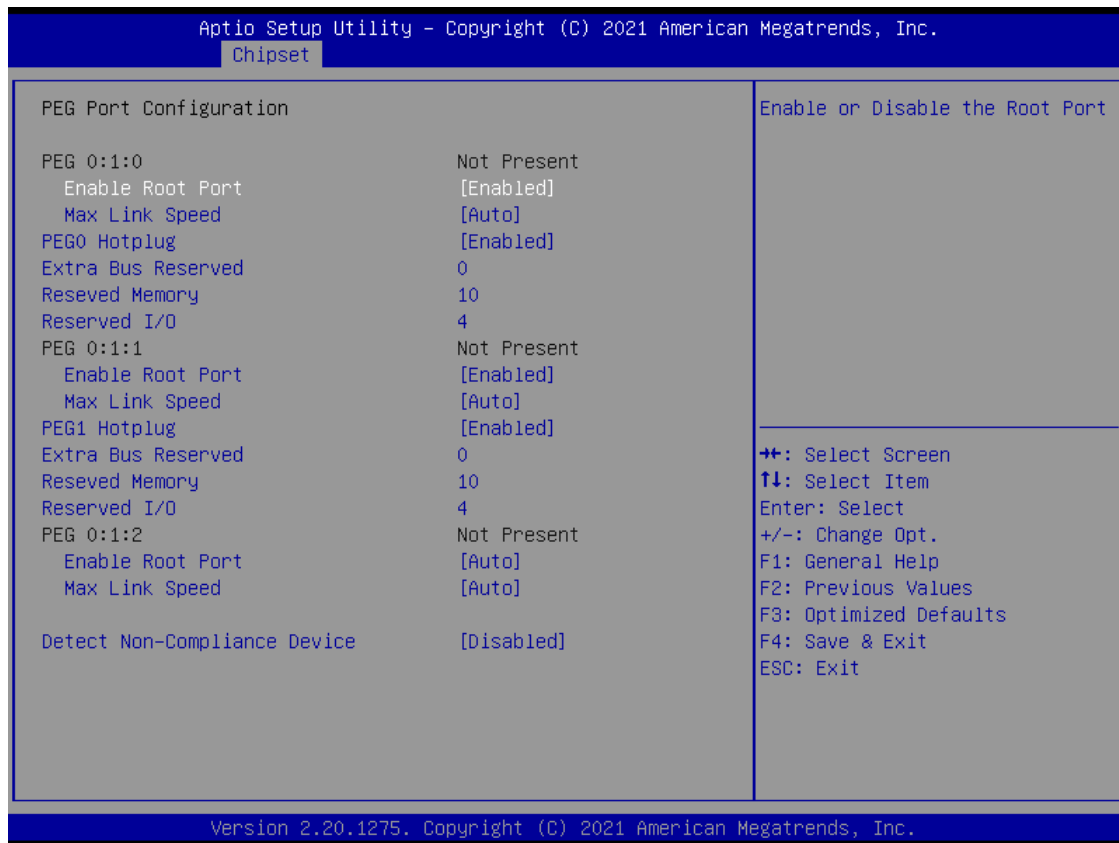

Item	Options	Description
Enable Root Port	Enabled[Default] , Disabled	Enable or Disable the Root Port
Max Link Speed	Auto[Default] , Gen1, Gen3, Gen3,	Configure PEG 0:X:X Max Speed
PEG0 Hotplug	Disabled[Default] , Enabled,	PCI Express Hot Plug Enable/Disable
Extra Bus Reserved	(0-7)	Extra Bus Reserved (0-7) for bridges behind this Root Bridge.
Reseved Memory	(1-4096)	Reserved Memory for this Root Bridge (1-4096) MB
Reserved I/O	(4K/8K/12K/16K/20K)	Reserved I/O (4K/8K/12K/16K/20K) Range for this Root Bridge.
Detect Non-Compliance Device	Disabled[Default] , Enabled,	Detect Non-Compliance PCI Express Device in PEG

4.4.2 PCH-IO Configuration

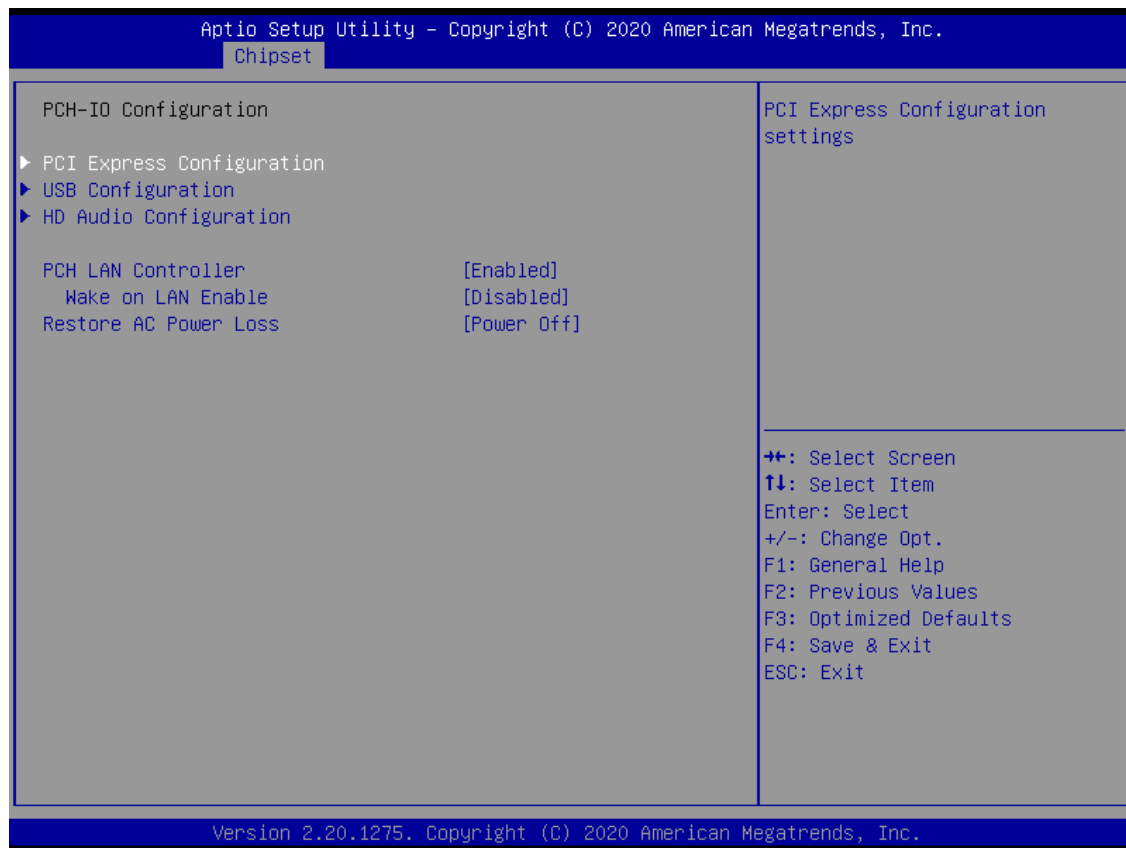

Item	Options	Description
PCH LAN Controller	Enabled [Default] , Disabled	Enable/Disable onboard NIC.
Wake on LAN Enable	Enabled, Disabled [Default]	Enable/Disable integrated LAN to wake the system.
Restore AC Power Loss	Power On, Power Off [Default] , Lase State	Specify what state to go to when power is re-applied after a power failure (G3 state).

■ PCI Express Configuration

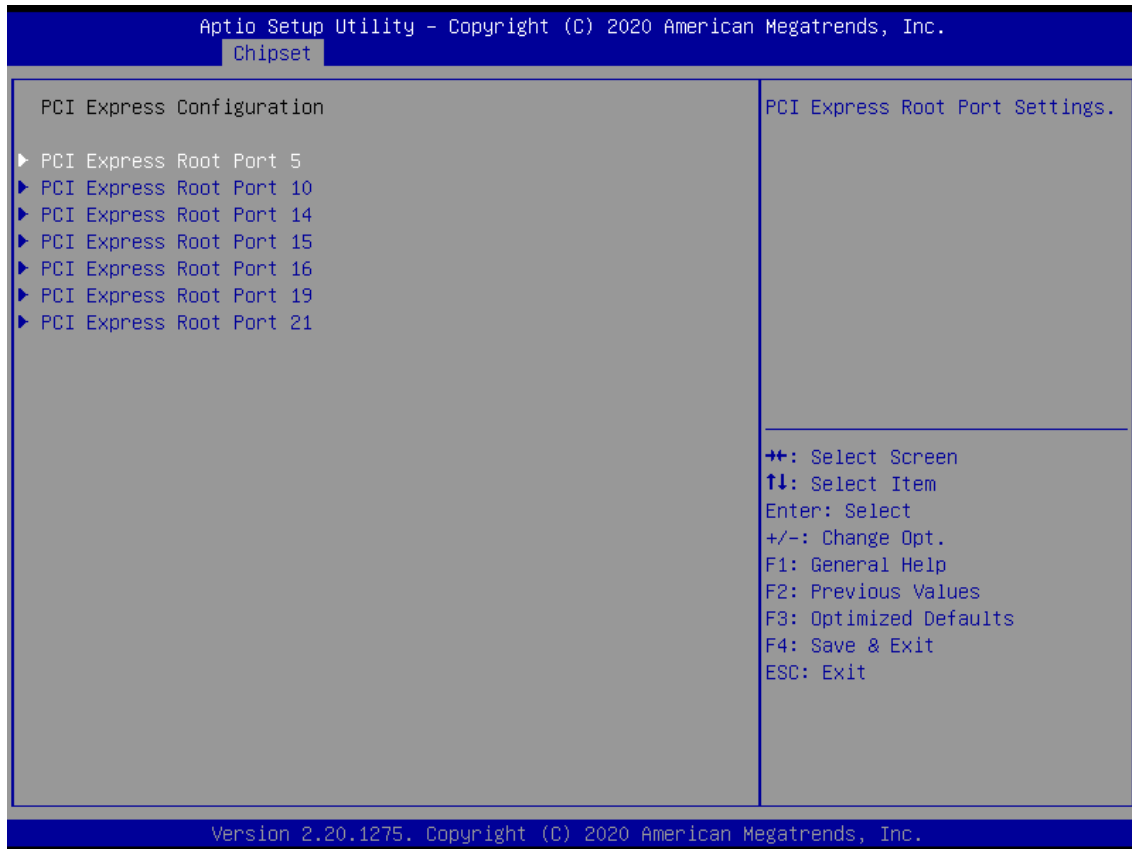

■ PCI Express Root Port 8 / 9 / 16

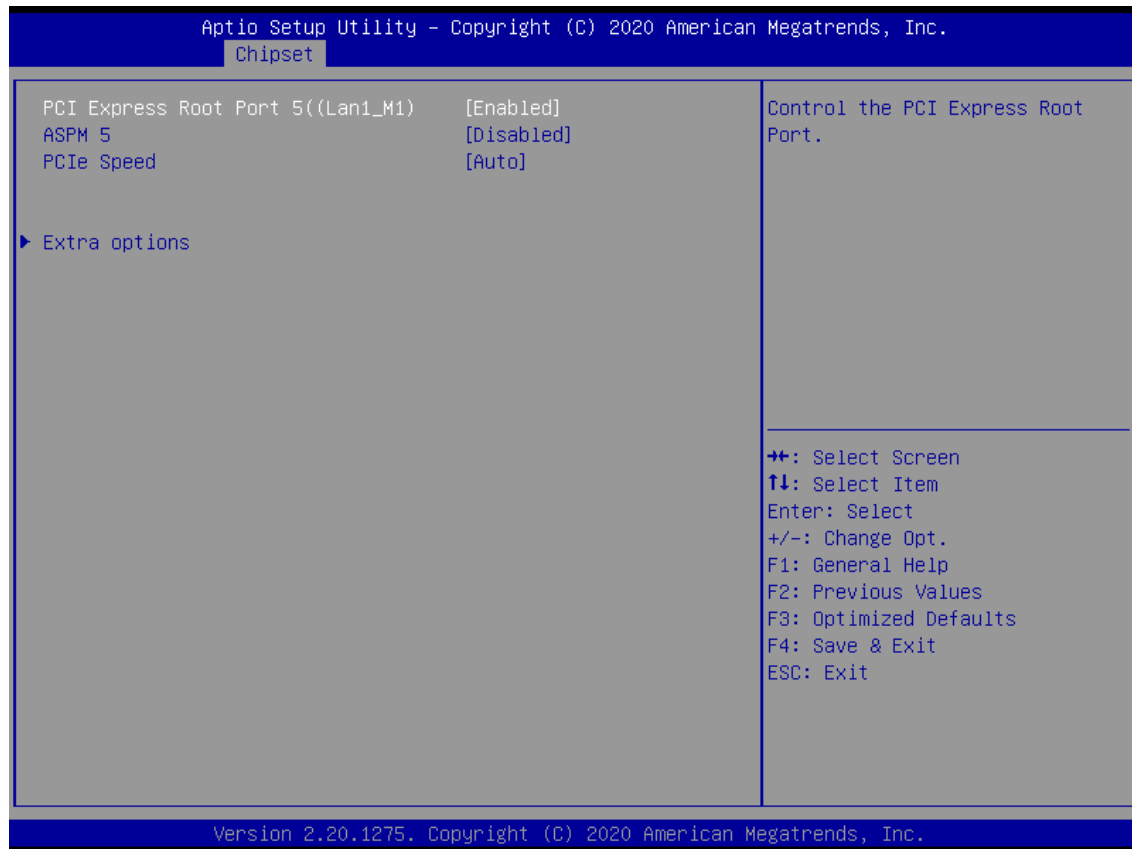

Item	Options	Description
PCI Express Root Port 5 /10 /14/15/16/19/21	Disabled [Default] , Enabled	Control the PCI Express Root Port.
ASPM	Disabled [Default] , L0s, L1, L0sL1, Auto	Set the ASPM Level: Force L0s - Force all links to L0s State, AUTO - BIOS auto configure, DISABLE - Disables ASPM,
PCIe Speed	Auto [Default] , Gen1, Gen2, Gen3	Configure PCIe speed.
Detect Non-Compliance Device	Disabled [Default] , Enabled	Detect Non-Compliance PCI Express Device. If enable, it will take more time at POST time.

■ USB Configuration

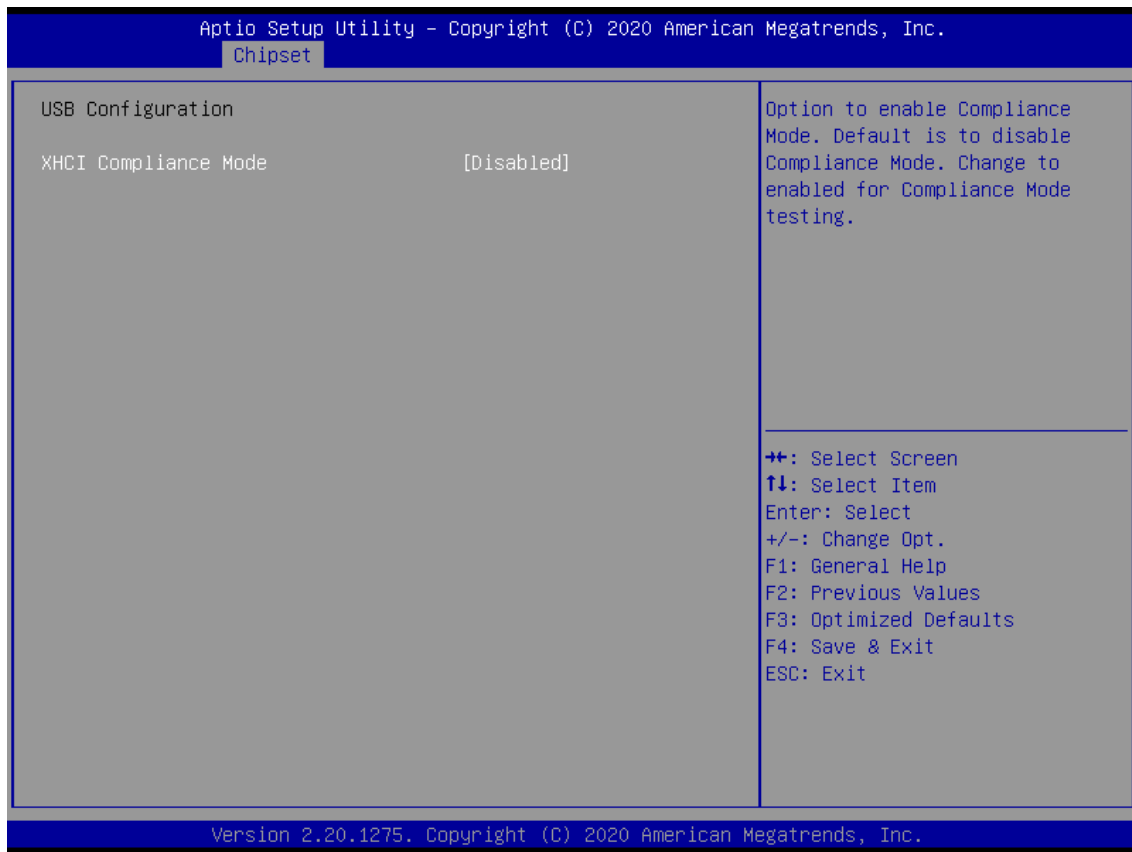

Item	Options	Description
XHCI Disable Compliance mode	Disabled [Default] , Enabled	Option to enable Compliance Mode. Default is to disable Compliance Mode. Change to enabled for Compliance Mode testing.

■ HD Audio Configuration

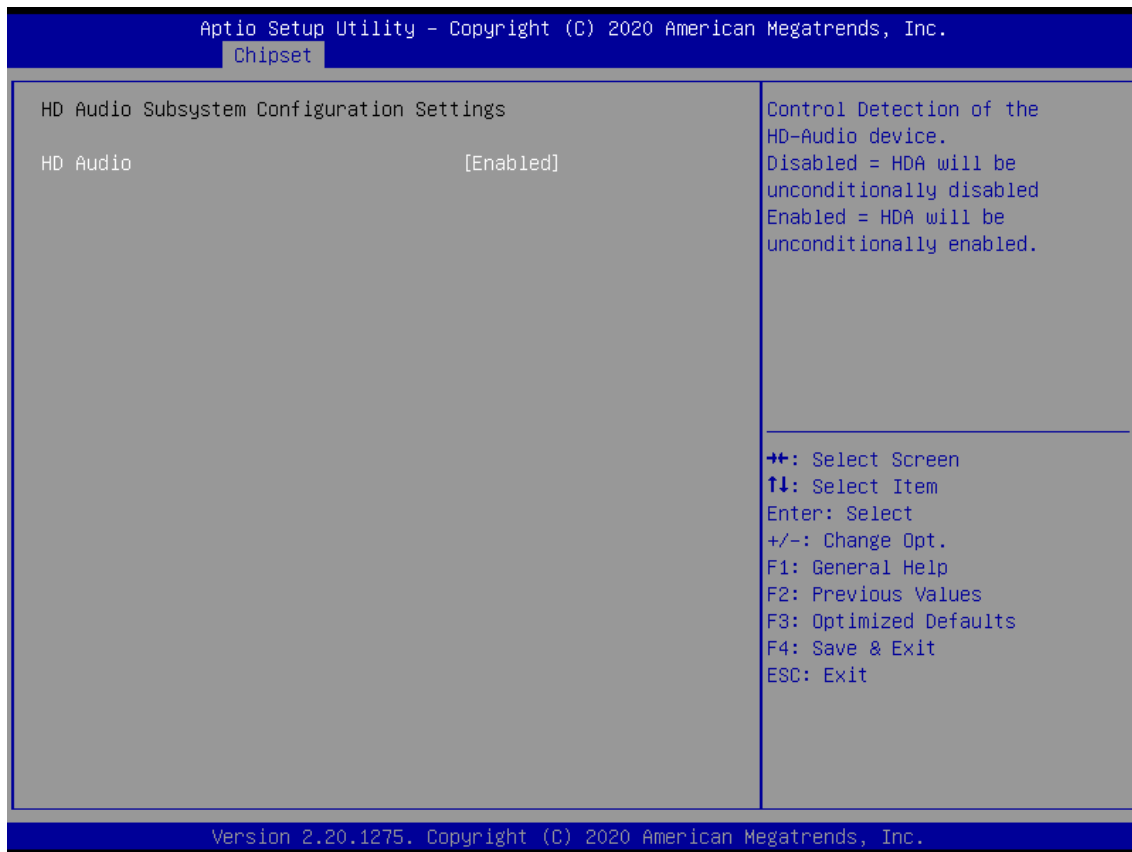

Item	Options	Description
HD Audio	Disabled, Enabled [Default]	Control Detection of the HD-Audio device. Disabled = HDA will be unconditionally disabled Enabled = HDA will be unconditionally enabled.

4.5 Security

Security menu allow users to change administrator password and user password settings.

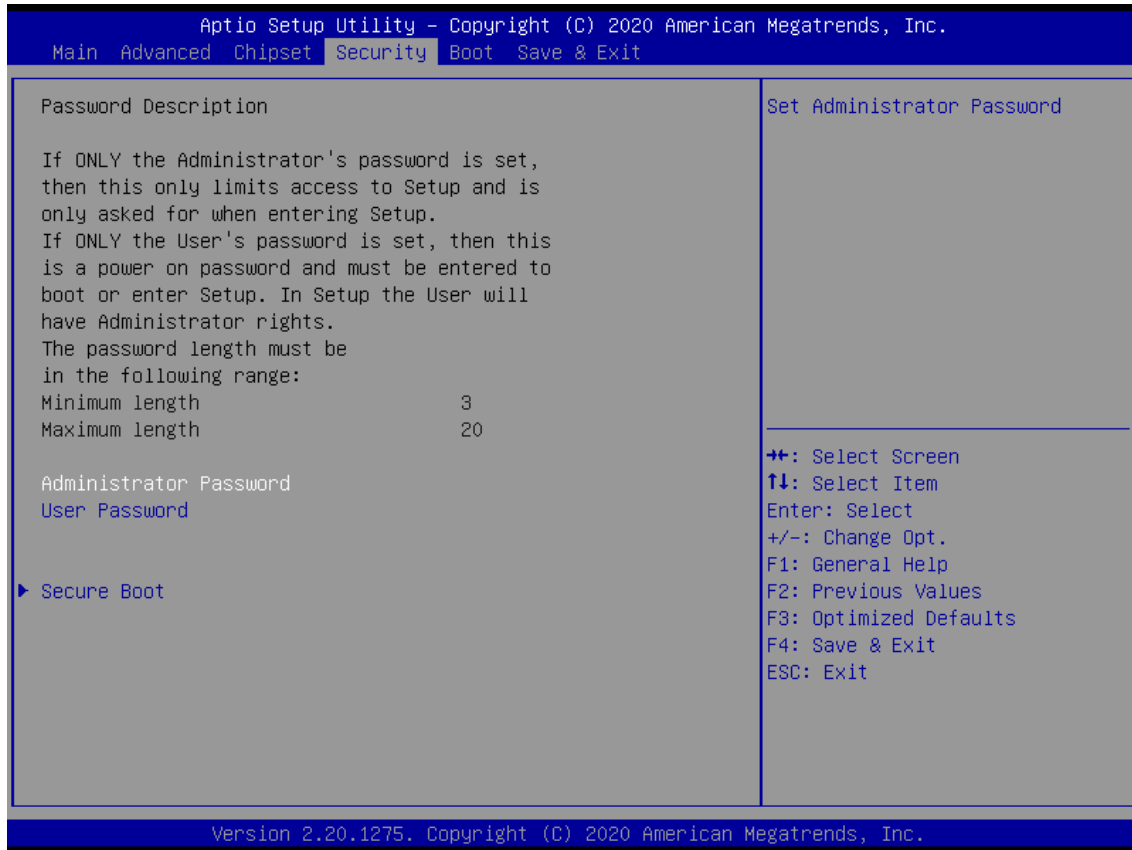

■ Administrator Password

This item allows you to set Administrator Password.

■ User Password

This item allows you to set User Password.

■ Security Boot

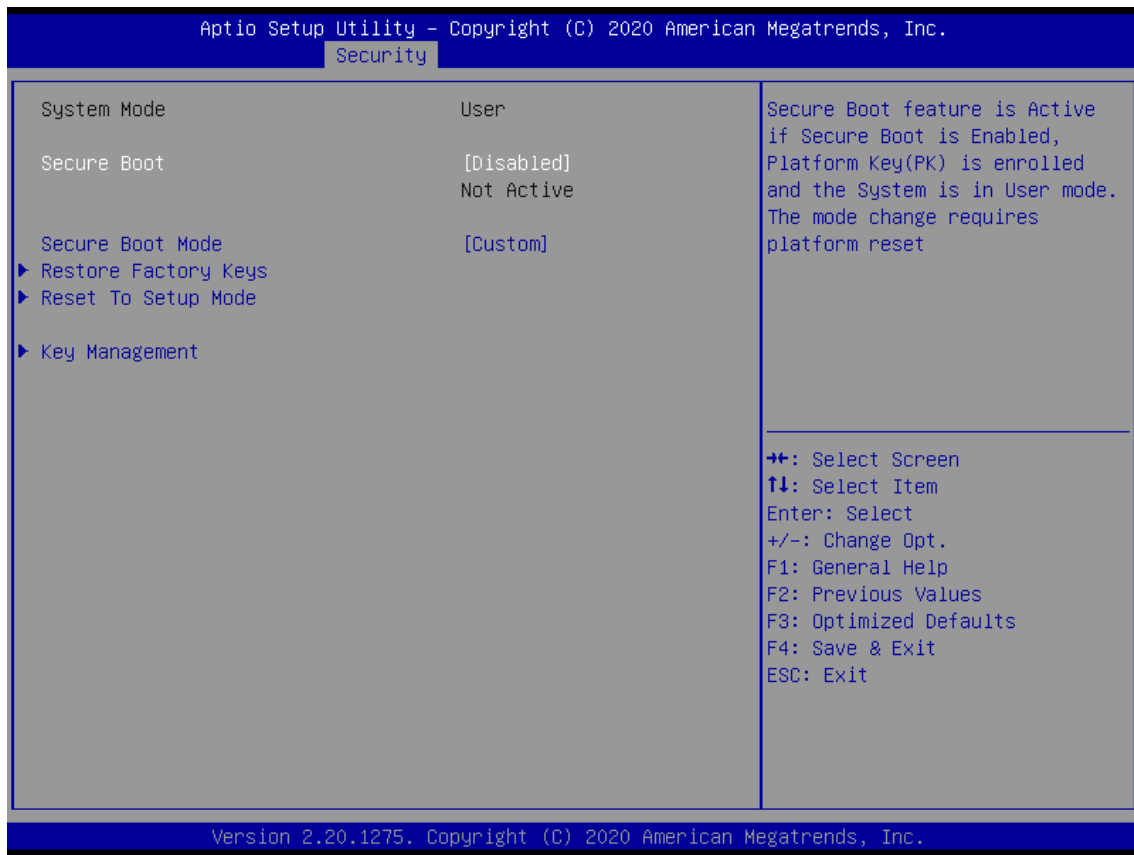

Item	Options	Description
Secure Boot	Disabled [Default] , Enabled	Secure Boot feature is Active if Secure Boot is Enabled, Platform Key(PK) is enrolled and the System is in User mode. The mode change requires platform reset
Secure Boot Mode	Standard, Custom [Default]	Secure Boot mode options: Standard or Custom. In Custom mode, Secure Boot Policy variables can be configured by a physically present user without full authentication

■ Key Management

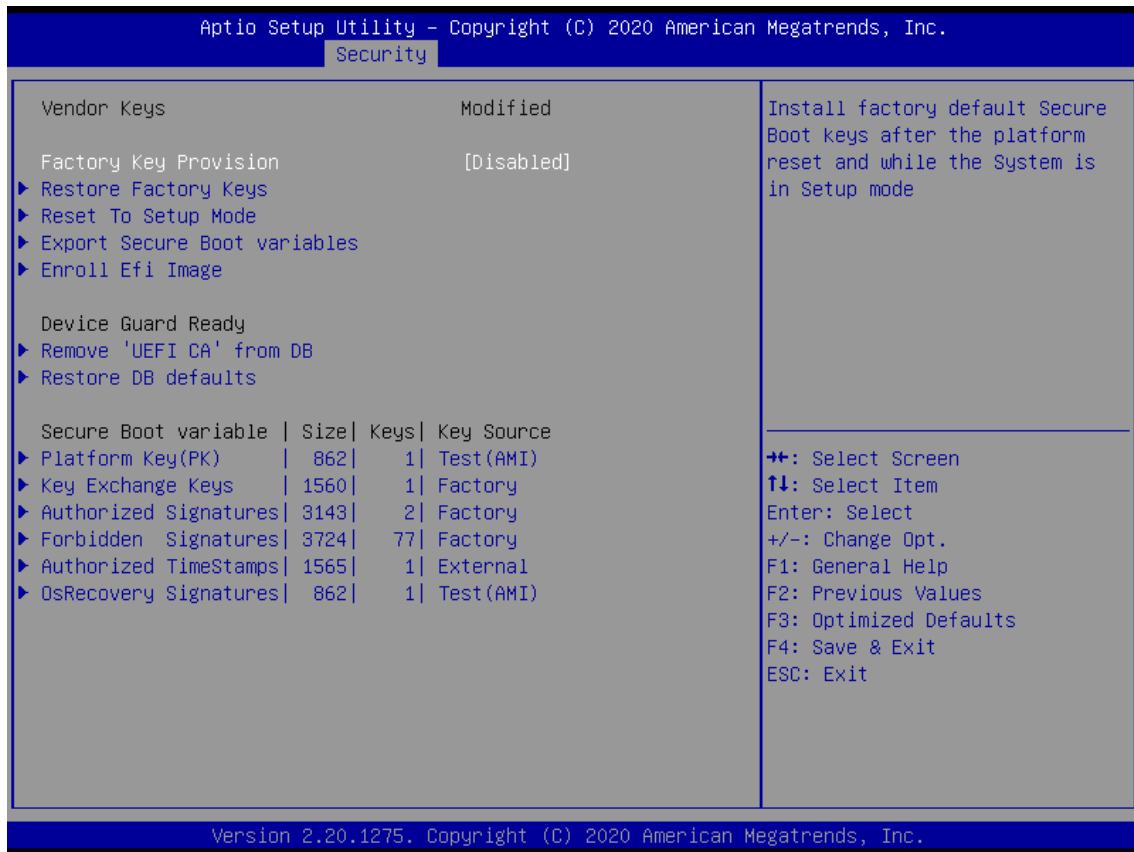

Item	Options	Description
Factory Key Provision	Disabled [Default] , Enabled	Install factory default Secure Boot keys after the platform reset and while the System is in Setup mode

4.6 Boot

This menu allows you to setup the system boot options.

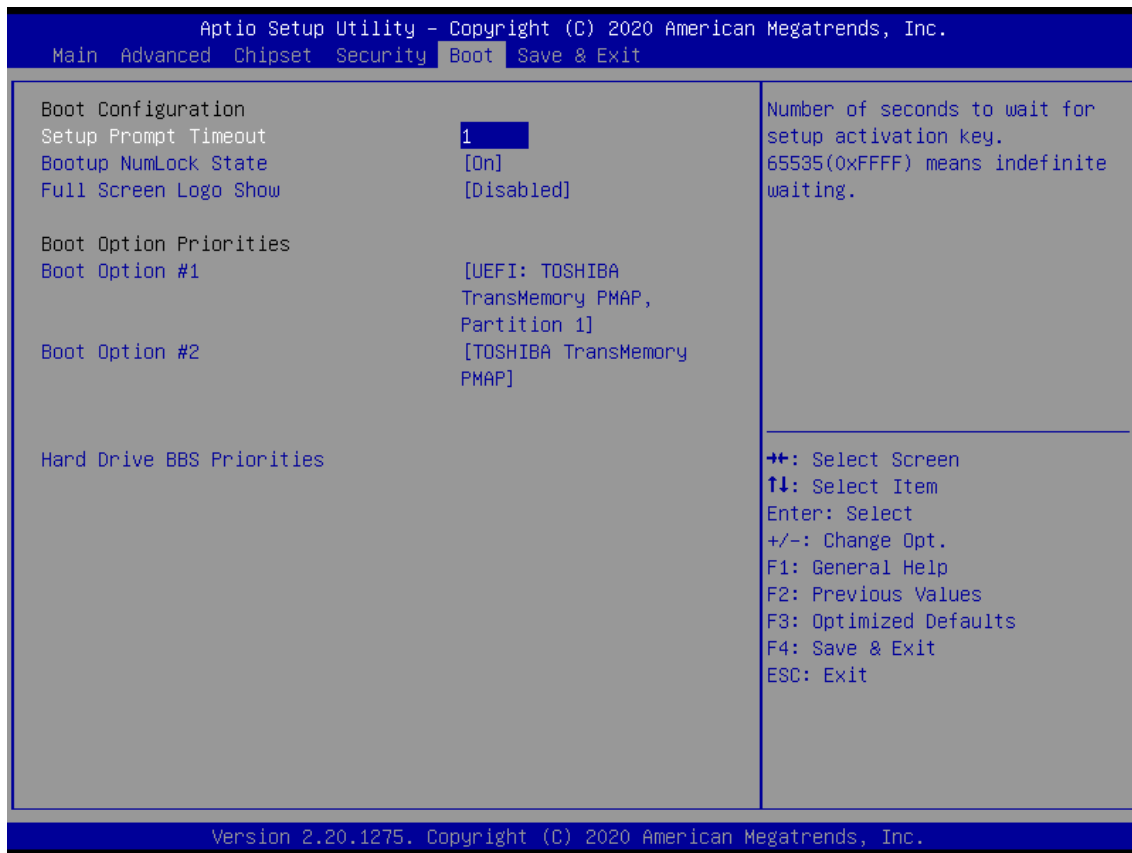

Item	Options	Description
Setup Prompt Timeout	1[Default]	Number of seconds to wait for setup activation key. 65535(0xFFFF) means indefinite waiting.
Bootup NumLock State	On[Default] , Off	Select the Keyboard NumLock state.
Full Screen Logo Show	Disabled[Default] , Enabled	Enables or disables Full Screen Logo Show option.
Boot Option #1		Set the system boot order.

4.7 Save & Exit

This setting allows users to configure the boot settings.

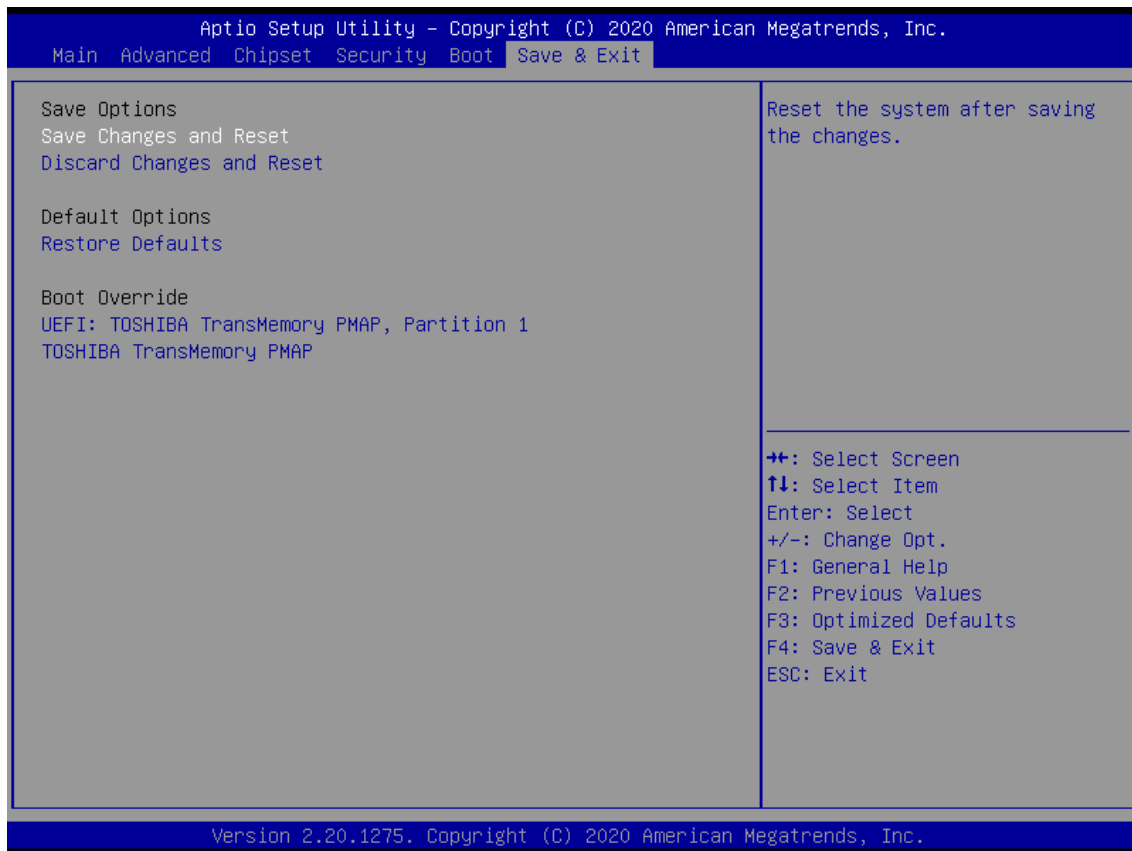

■ Save Changes and Reset

This item allows user to reset the system after saving the changes. This item allows user to reset the system after saving the changes.

■ Discard Changes and Reset

This item allows user to reset the system without saving any changes.

■ Restore Defaults

Use this item to restore /load default values for all the setup options.

Appendix

WDT & GPIO

This appendix provides the sample codes of WDT (Watch Dog Timer) and GPIO (General Purpose Input/ Output).

WDT Sample Code

WDT Setting

Psuedo Code

```
#define AddrPort          0x2e
#define DataPort         0x2f
#define SIO_UnLock_Value 0x87
#define SIO_Lock_Value   0xaa
#define WATCHDOG_LDN    0x08
#define GPIO_Port        0xF1

//Enter_Config
WriteByte (AddrPort, SIO_UnLock_Value);
WriteByte (AddrPort, SIO_UnLock_Value);

//Enter WATCHDOG LDN
WriteByte (AddrPort, 0x07);
WriteByte (DataPort, WATCHDOG_LDN);

//Set count mode
WriteByte (AddrPort, 0xf0);
buf2 = ReadByte (DataPort) & 0xf4; //clear "Select Watchdog Timer I count mode
buf2 |= 0x02; //Enable the Watchdog Timer I output low pulse to the KBRST# pin
// buf2 |= 0x08; //Bit3 = (1:Minute Mode/0:Second Mode)
WriteByte (DataPort, buf2); //Write back

//Set watch dog time value
WriteByte (AddrPort, 0xf1)
WriteByte (DataPort, Time) //Set watch dog time value

// close config mode
WriteByte (AddrPort, 0xaa);
```

GPIO Sample Code

GPIO Setting

PIN#	GPIO#	Default Configuration
18	XCOM-	
17	XCOM+	
16	OUT8	DIO Output8
15	IN8	DIO Input8
14	OUT7	DIO Output7
13	IN7	DIO Input7
12	OUT6	DIO Output6
11	IN6	DIO Input6
10	OUT5	DIO Output5
9	IN5	DIO Input5
8	OUT4	DIO Output4
7	IN4	DIO Input4
6	OUT3	DIO Output3
5	IN3	DIO Input3
4	OUT2	DIO Output2
3	IN2	DIO Input2
2	OUT1	DIO Output1
1	IN1	DIO Input1

The GPIO function is provided by Nuvoton NCT6106D, and it can be accessed through its GPIO index/data port. To access the GPIO register, write index to the index port, and then read/write from/to data port. The configuration on the VCO-6000 is described as below.

Pseudo Code

```
#define AddrPort      0x2e
#define DataPort     0x2f
#define SIO_UnLock_Value 0x87
#define SIO_Lock_Value  0xaa
#define SIO_LDN_GPIO  0x07
#define GPIO_Port     0xF1
```

```
//Enter_Config
```

```
WriteByte (AddrPort, SIO_UnLock_Value);
WriteByte (AddrPort, SIO_UnLock_Value);
```

```
WriteByte (AddrPort, 0x07);
WriteByte (DataPort, SIO_LDN_GPIO);
```

```
//Set OUT1~OUT8Value
```

```
WriteByte (AddrPort, GPIO_Port);
WriteByte (DataPort, 0x00); //set OUT1~OUT8 value, OUT1=Bit0, OUT2=Bit1
```

Bit 7	Bit 6	Bit 5	Bit 4	Bit 3	Bit 2	Bit 1	Bit 0
OUT8	OUT7	OUT6	OUT5	OUT4	OUT3	OUT2	OUT1

```
// Read In1~In8 value
```

```
WriteByte (AddrPort, 0xED);
Data= ReadByte (DataPort); //Read In1~In8 value
```

Bit 7	Bit 6	Bit 5	Bit 4	Bit 3	Bit 2	Bit 1	Bit 0
IN8	IN7	IN6	IN5	IN4	IN3	IN2	IN1

```
// close config mode
```

```
WriteByte (AddrPort, SIO_Lock_Value);
```

