



KCO Series : Fanned Industrial Computers

Expansion Card Acceleration for Inspection & Intelligent Computer Vision

With the ever-growing demand for higher performance computing for AI applications, edge computing solutions have evolved and overcome significant challenges to provide and meet these exceeding demands. Transformative technologies and innovation have led to the shift in compute from datacenters to on-premises for real-time processing, inference, and insights.

Introducing the KCO-RPL Series, a line of high-performance fanned industrial computers powered by Intel's latest 13th Gen Raptor Lake processor. These ruggedized edge computers house our 12/13/14th gen mATX industrial motherboard (CT-MRL01) for extensive scalability and IIoT-centric flexibility for seamless optimization in high-spec deployment applications. Additionally, the KCO-RPL Series provides a number of edge-native features to accommodate and ensure reliable performance at the rugged edge.

KCO-2000/3000-RPL Features:

- 14th/13th/12th Gen Intel Core Processors
- 4x DDR4 DIMM Max 128GB
- Dual-GPU Support (KCO-3000-RPL Exclusive)
- LGA 1700 with Q670E Chipset
- PCIe Gen 4 & 5 Expansion
- 2U Height KCO-2000-RPL & 3U Height KCO-3000-RPL



Factory Automation



Intelligent Gateways



IIoT & Robotics



Surveillance



Intelligent Healthcare



Security



Smart Retail Solutions



Industrial-Grade Chassis and Dust Filter

The KCO-RPL Series takes a standardized COTS (commercial off-the-shelf) approach to provide essential edge computing building blocks for industrial deployment applications. The KCO-2000-RPL follows a 2U short depth form factor and is easily integrated into space-constrained locations such as medical carts and smart kiosks. Meanwhile, the KCO-3000-RPL has a 3U rack mountable design to support full-height performance accelerator cards and dual-GPU configurations.



KCO-2000-RPL: 2U Short Depth chassis

- 324 (W) x 276 (D) x 89 (H) mm



KCO-3000-RPL: 3U Rack Mountable chassis

- 334 (W) x 300 (D) x 133 (H) mm

The KCO chassis is designed with robust metals to provide ruggedized housing for sensitive internal components and shield against exposure from harsh environmental conditions. Industrial intake fans regulate interior thermals and provide the necessary ventilation for the heat generating components. Dust, debris, and contaminants accumulation are detrimental to the performance and longevity of computers. To combat these particulates, washable hot-swap dust filters are incorporated to significantly reduce and capture particulates before they enter the system.

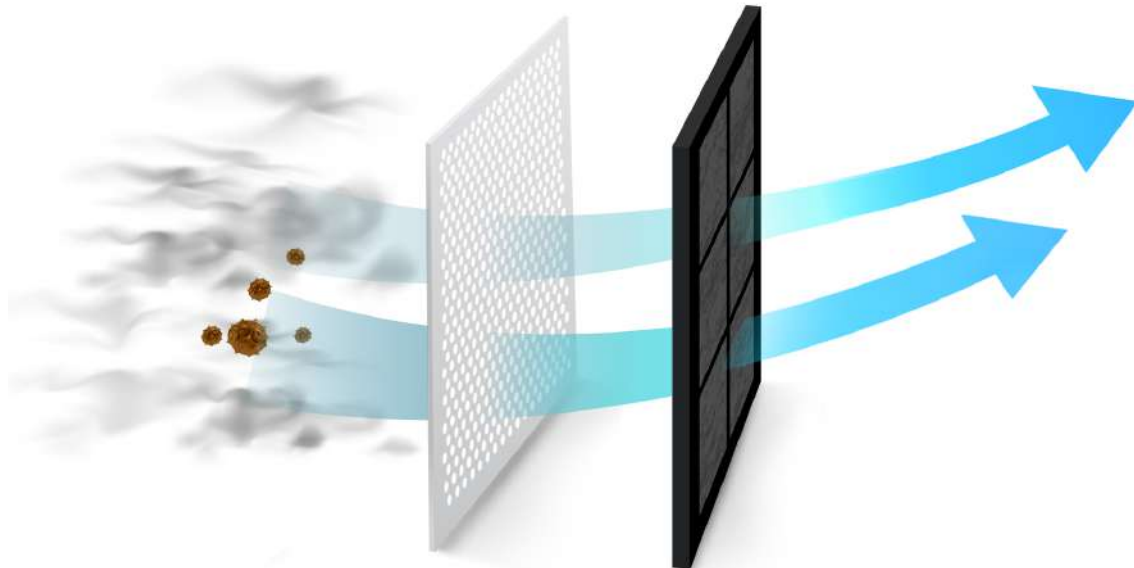

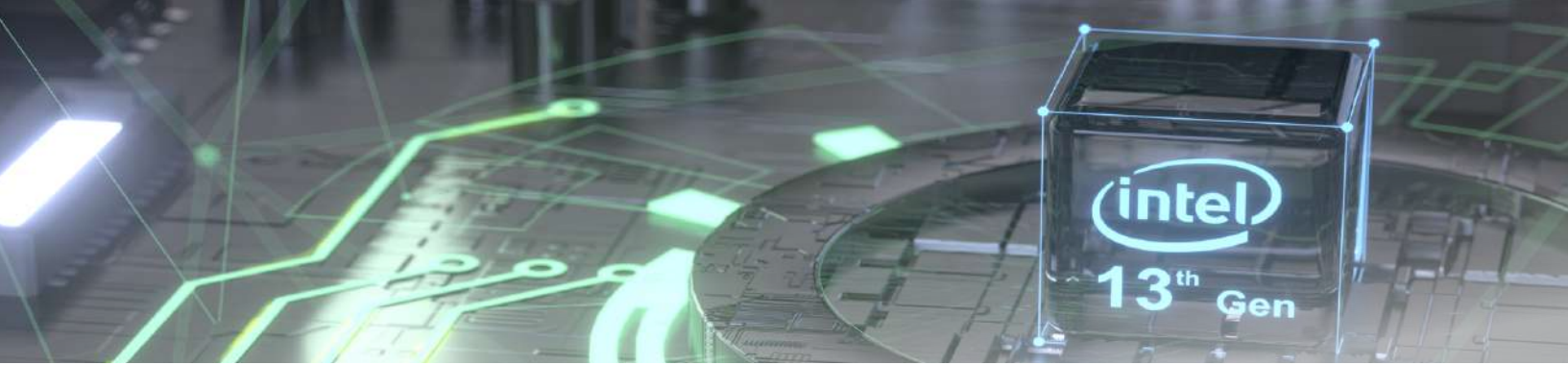

Leveraging Intel's Hybrid-Architecture

Deliver the optimal edge AI performance with the KCO-RPL Series, featuring the advanced LGA 1700 socket. This zero-insertion force, flip-chip land grid array (FCLGA/LGA) socket with 1700 contact points takes center stage, enabling seamless compatibility for Intel® Raptor Lake (13th Gen) and Intel® Alder Lake (12th Gen) processors. Intel's 13th Gen. and 12th Gen CPUs leverage the new Performance Cores (P-core) and Efficient Cores (E-core), delivering unprecedented performance with the new hybrid architecture.

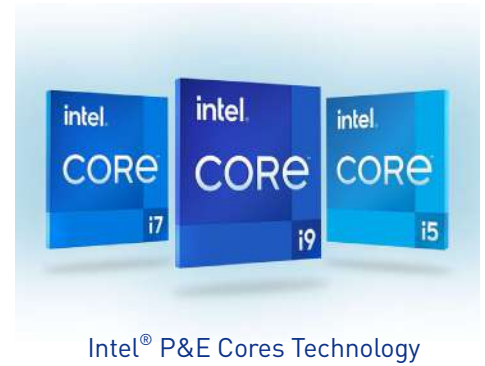

Intel® P&E Cores Technology

Meeting Edge Processing Performance & Power Efficiency Needs

At the heart of these processors lies the groundbreaking P&E cores technology. This innovative hybrid design adopts a two-core strategy. The larger, performance-driven cores (P-core) handle compute-intensive and AI workloads, while the smaller, energy-efficient cores take care of high-density and scale-out workloads in the background. Designed to strike the perfect balance between high performance and energy efficiency, the KCO-RPL Series excels across various industrial applications.

Key Advantages:

- Intel Thread Director: Optimizes OS workload to cores distribution
- Up to 24 Cores: 8 Performance-cores, 16 Efficient-cores
- Up to 32 Threads: P-cores up to 5.8 GHz
- Increased L2 & L3 Cache: compared to the previous generation



Harnessing the Full Power of P&E Cores with Windows 11

Intel's 13th Gen Core features a unique dual-core design, featuring P-cores, E-cores, and hyper-threads on P-cores, which introduces a new dimension in multi-core optimization. In response, Intel collaborated with Microsoft to introduce a hybrid-aware scheduler in Windows 11. This allows the operating system (OS) to prioritize fresh cores before tapping into hyper-threads. At the heart of this breakthrough is Intel's Thread Director, a microcontroller within the CPU. It uses machine learning to optimally schedule tasks on the right core at the right time. This allows us to ensure that P-core and E-core are working in synergy. With Windows 11, users can further enhance the performance and efficiency of the KCO-RPL Fanned Industrial Computer.





High-Capacity DDR4 RAM

With an expansive 128GB capacity, the KCO-RPL Series addresses high load demands of modern AI applications and efficiently manages complex multi-task workloads. DDR4 combines speed, efficiency, and flexibility for highly responsive productivity and data-driven decision-making in dynamic edge computing environments.



Rich I/O

The KCO-RPL Series provides an extensive amount of I/O for uncompromised connectivity and compatibility at the rugged edge. Supporting 6x USB 3.1 Gen 2 ports at 10 Gbps and 6x Serial ports (RS-232) on-board, the KCO series maximizes IoT configurability to power and relay data for multiple IoT devices simultaneously. In deployments that require even greater data transfer rates, the KCO-RPL features a USB 3.2 Gen 2x2 Type-C, delivering speeds up to 20 Gbps.

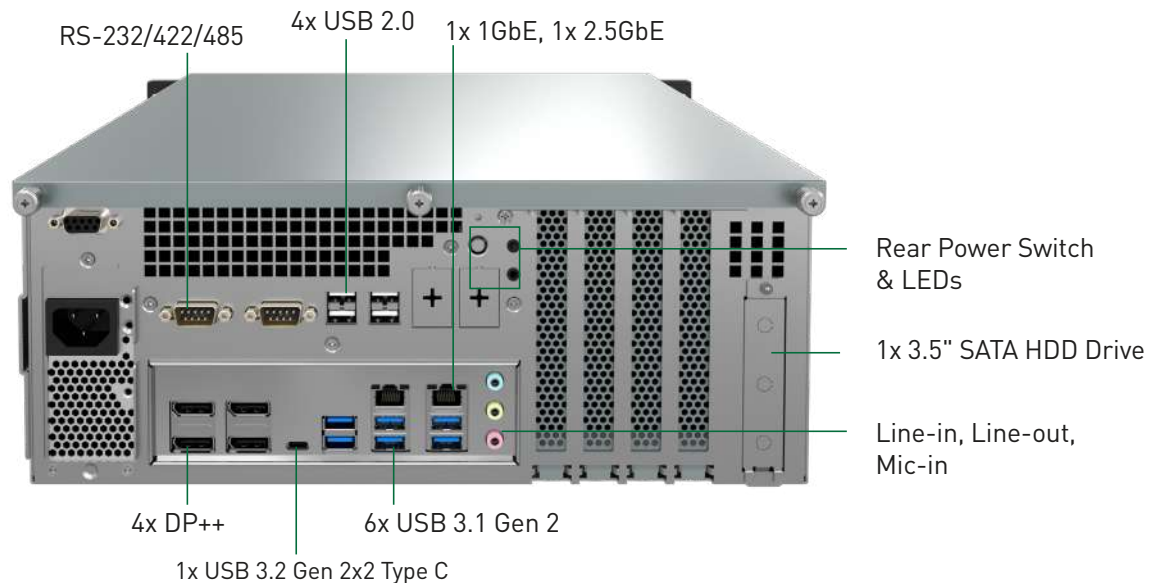

Supporting 4K Independent Displays

Simultaneously display up to four true 4K independent displays for ultimate data visualization with the available four DP++ ports on-board. Powered by Intel® UHD Graphics on Xe Architecture, the KCO-RPL can deliver up to 8K HDR video, ensuring vibrant, high-quality visuals for edge applications.



4x Independent Displays

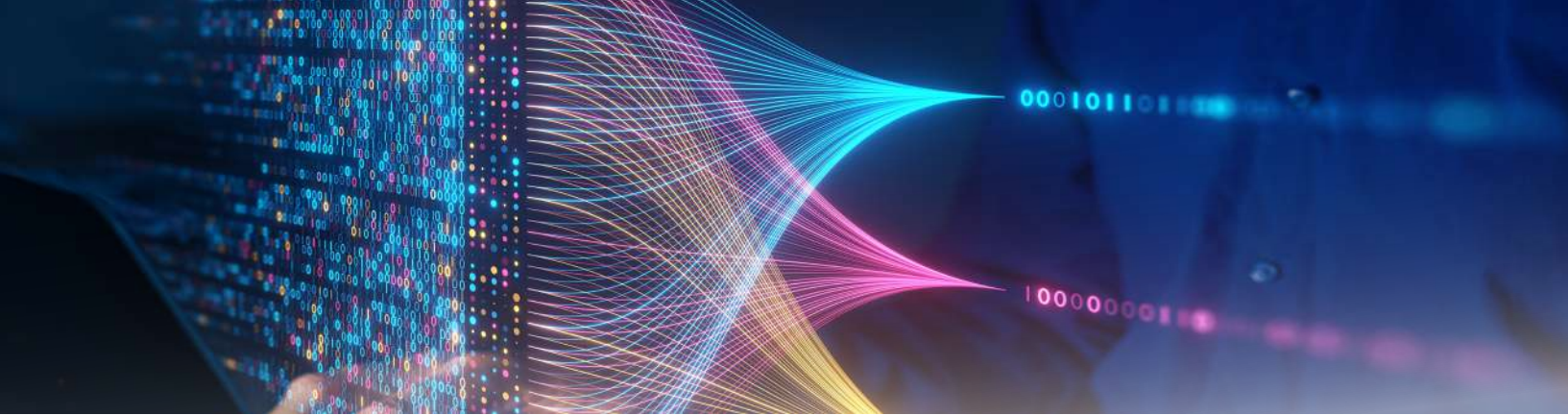

PCIe Gen 4 & 5 Expansion with Dedicated GPU Support

Optimize and fine-tune the KCO-RPL Series to meet high-specification deployment requirements and enable resource-intensive AI workloads with PCIe expansion. Add-on expansion cards offer expanded I/O connectivity options, capture cards, and other delegated performance accelerators. Leveraging the latest PCIe Gen 5 standards, the KCO-RPL Series delivers exhilarating data throughput speeds of 32GT/s. These remarkable speeds and bandwidth allow performance accelerators to operate at full efficiency and effectiveness.

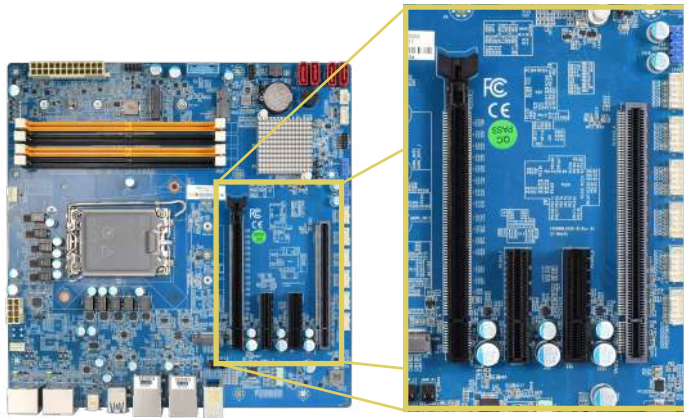

- 1x PCIe x16 Slot (Gen 5)
- 2x PCIe x4 Slot (Gen 4 & Gen 3, Open End)
- 1x PCIe x16 Slot (Gen 4, 4-Lane)

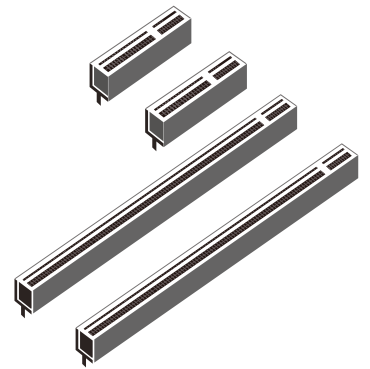

The KCO-RPL is compatible with a selection of dedicated GPUs to enable and process AI workloads. GPU performance acceleration is necessary for real-time parallel processing workloads such as machine learning, vision AI applications, and similar edge AI workloads.

Tested & Validated GPU Compatibility

KCO-2000-RPL

Low-profile (Max 6.6" Length)

- NVIDIA RTX A1000
- NVIDIA RTX 2000
- NVIDIA RTX 2000 ADA
- NVIDIA RTX 4000 SFF ADA

KCO-3000-RPL

Full Height (Max 8.5" Length)

- NVIDIA RTX A1000
- NVIDIA RTX A2000
- NVIDIA RTX 2000 ADA
- NVIDIA RTX 4000 SFF ADA
- NVIDIA RTX 4000 ADA
- NVIDIA RTX 4500 ADA
- NVIDIA RTX 5000 ADA





Dual-GPU Integration (KCO-3000-RPL Exclusive)

By leveraging the available PCIe x16 Gen 5 and PCIe x16 Gen 4 (4-lane) slots, the KCO-3000-RPL is engineered to support dual-GPU configurations. The KCO-3000-RPL supports dual-GPU configurations specifically for edge applications that require maximizing performance for real-time edge AI and machine vision applications efficiencies

- 1x PCIe x16 Slot (Gen 5)
- 1x PCIe x16 Slot (Gen 4, 4-Lane)
- 2x PCIe x4 Slot (1x Gen 4, 1x Gen 3, Open End)



On-board NVMe & Expandable SATA Storage

Ensure real-time data processing and reliable storage redundancy with scalable NVMe and SATA storage options. Optimize high-speed data storage aggregation with on-board M.2 M-Key slots available on both KCO-RPL Series. Exclusive to the KCO-2000-RPL Series, is a hot-swappable 7mm SATA bay for seamless data offloading procedures. The KCO-3000-RPL offers two SATA storage configurations for: 1x 3.5" SATA bay for cost-efficiency or 2x 2.5" SATA bays for even greater data storage capacity and redundancy.

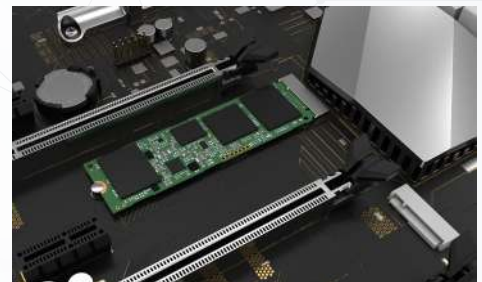

World-Class Certifications

At C&T, we pride ourselves in providing reliable and competent edge computing solutions. After undergoing stringent testing and validation for safety standards compliance, the KCO-RPL Series has received UL Certification. Gain peace of mind and deployment confidence knowing that the KCO-RPL Series has been thoroughly evaluated to operate under specific safety criteria.

UL 62368 Ed. 3 | FCC Class A | CE



We Create World-Class Edge Computers
For Your Industry-Leading Solutions

KCO-2000/3000-RPL SERIES

intel
Raptor Lake / Alder Lake



Model	KCO-2000-RPL	KCO-3000-RPL
	Industrial Computer with 2U Certification-Ready, 12/13/14 th Gen Intel [®] Core [®] Processor	Industrial Computer with 3U Certification-Ready, 12/13/14 th Gen Intel [®] Core [®] Processor
CPU Support	Support 12/13/14 th Gen Intel [®] Core™ i9/i7/i5/i3 Alder lake-S, Raptor Lake-S Processor (LGA 1700, 65W Max TDP)	
Memory	4x DDR4 2133/2400/2666MHz DIMM. 128 GB Max	
Graphic Output	4x DP++	
I/O	2x RJ45 (2.5 GbE & 1 GbE), 6x RS-232 (4x internal), 2x RJ45 (2.5 GbE & 1 GbE), 6x USB 3.1 Gen 2 (10Gbps), 1x USB 3.2 Gen 2x2 Type C (20 Gbps), 4x USB 2.0, 2x USB 3.0 Gen 1 (internal), 8-bit digital I/O (internal)	2x RJ45 (2.5 GbE & 1 GbE), 6x RS-232 (4x internal), 2x RJ45 (2.5 GbE & 1 GbE), 6x USB 3.1 Gen 2 (10Gbps), 1x USB 3.2 Gen 2x2 Type C (20 Gbps), 4x USB 2.0, 2x USB 3.0 Gen 1, 8-bit digital I/O (internal)
Storage	1x M.2 M / NVMe PCIe x 4 / 2242, 2260, 2280 1x M.2 M / NVMe PCIe x 4 / SATA / 2242, 2260, 2280 1x M.2 E / PCIe x2 / USB 2.0 / 2230	
Internal Expansion Slot	1x PCIe x16 Slot (Gen 5), 1x PCIe x16 Slot (Gen 4, 4-Lane) 1x PCIe x4 Slot (Gen 4, Open End), 1x PCIe x4 Slot (Gen 3, Open End)	
Power	ACPI 5.0 compliant, 100-240V AC @50/60Hz	
Audio	1x Mic-in, 1x Line-in, 1x Line-out	
Operating Temperature	UL : 0 °C to 40 °C CE/FCC/IC : 0 °C to 50 °C	0°C to 50°C
Dimensions (WxDxH)	324 x 276 x 89 mm	334 x 300 x 133 mm
Weight	5 KG (barebone w/ chassis, mb, and PSU only)	
Certifications	CE, FCC, UL 62368 Ed. 3	